

Brochure

Radio Access Verification with VIAMI's OneAdvisor-800

VIAMI's OneAdvisor-800 is the ideal portable test solution to verify and troubleshoot radio access networks for proper deployment and effective operation.

OneAdvisor design is based on a multi-functional architecture, covering different test applications, scaling and adapting to different user's groups, including among others:

- Radio construction, covering all test aspects of the transmission lines of any cell site, validating coaxial cable, antennas, as well as fiber characterization and inspection.
- Radio operation, covering radio's transmission verification according to 3GPP standards, maintenance practices assessing radio's power level and coverage, as well as the ability to identify and locate interference impairments.

Key test functions include:

- Cable and antenna reflection tests, distance to fault and cable loss
- Fiber inspection and fiber validation including OTDR testing
- Real-time persistence spectrum for 5G FR1 (9KHz to 6GHz)
- Spectrum analysis with gated sweep for interference analysis in LTE or 5G TDD signals
- RFoCPRI interference analysis to effectively characterize interfering signals as received by the radio
- Over-the-Air RF spectrogram testing and logging capability to effectively characterize intermittent interference signals
- Automatic Interference location when is paired with VIAMI's InterferenceAdvisor
- Interference finding with triangulation when is paired with VIAMI's AntennaAdvisor
- Spectrum route map, validating radio's coverage and signal propagation



OneAdvisor Fiber Validation

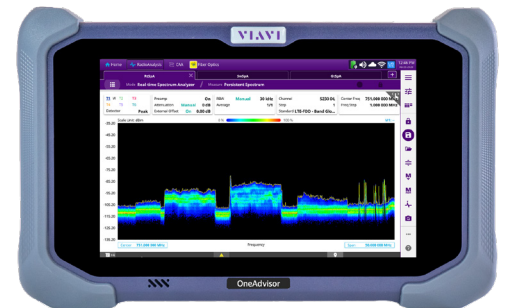

OneAdvisor Realtime Persistence Spectrum



OneAdvisor RFoCPRI Interference Analysis

Real-Time Persistence Spectrum

OneAdvisor real-time spectrum analysis (RTSA) performs a persistence power measurement in high-speed providing a comprehensive view of intermittent signals for a fast characterization of wireless signals and the identification of intermittent interference signals through its 2D and 3D spectrogram measurements that characterize signals in power, frequency and time.

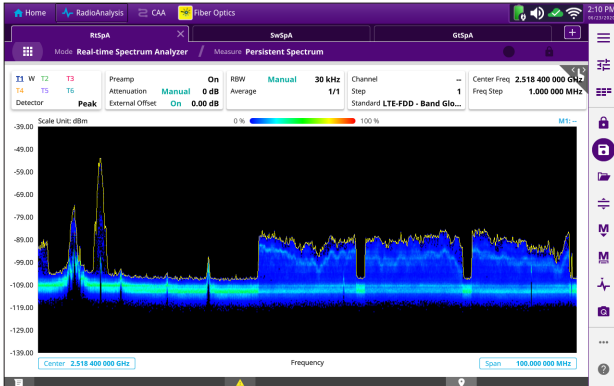

Real-time Spectrum Analysis

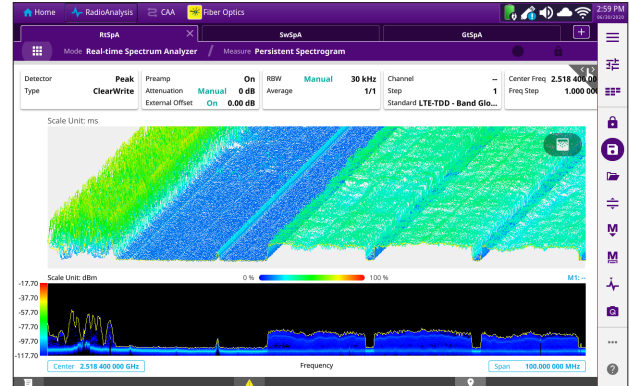

Real-Time 3D Spectrogram

OneAdvisor's RTSA is ideal to properly characterize signals that have different communication profile in time-domain, such as time division duplex (TDD) transmissions which in the same frequency channel allocates different time-slots for uplink and downlink signals which is the case of 5G carriers above 3GHz, and it also provides the ability to identify the presence and location of 5G beam signals, also referred as synchronization signal block (SSB), thanks to its 100MHz of instantaneous analysis bandwidth.

Interference Analysis

OneAdvisor Interference Analyzer functions provides the most comprehensive measurement techniques to effectively identify, characterize and locate interfering signals.

Key interference analysis measurement functions:

- RFoCPRI interference analysis
- Interference Finder
- Received Signal Strength Indicator (RSSI)
- Spectrum Re-player

RFoCPRI Interference Analysis

RFoCPRI technology performs RF measurements through the fiber fronthaul which is the link between base band units and remote radio heads.

RFoCPRI verifies the control signals and extracts the RF (IQ) data transmitted between the BBU and RRH at the ground without the need to climb the tower.

Key benefit of RFoCPRI is that it enables monitoring and analysis of uplink signals (mobile devices), and PIM detection, precisely as they are received by the cell site.

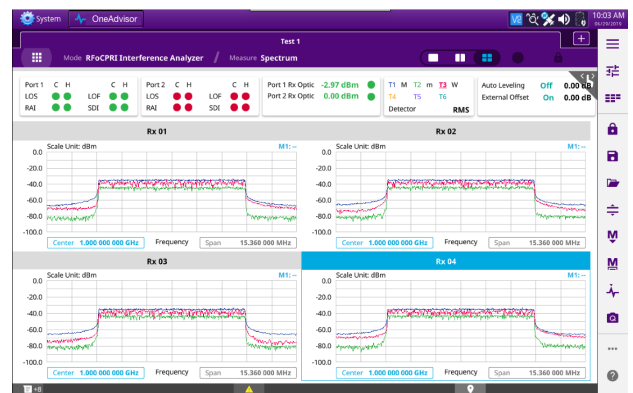

OneAdvisor RFoCPRI (MIMO 4x4)

Received Signal Strength Indicator (RSSI)

RSSI performs a multi-signal measurement (up to 6 simultaneously signals) in time, assessing the power-level variations of interference signals over time.

In RSSI measurements power limits can be set for audible alarms and increase alarm counters every time a signal exceeds the defined limit line.

For long-term analysis, the spectrogram and RSSI measurements can be saved into an external USB memory for post-analysis.

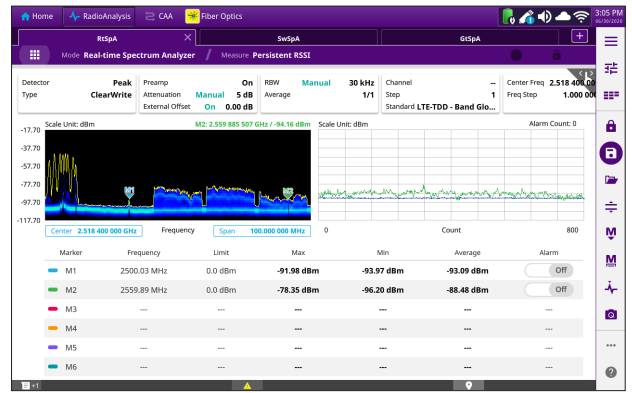

OneAdvisor RSSI Measurement

Spectrum Logging and Replaying

Spectrum can be logged and replay to identify intermittent interference signals.

Spectrum measurements logged can be played back in the spectrum, spectrogram or RSSI mode, and limit lines can be set to create failure points when signals exceed it.

The failure points are clearly displayed on the trace timeline for quick access during playback.

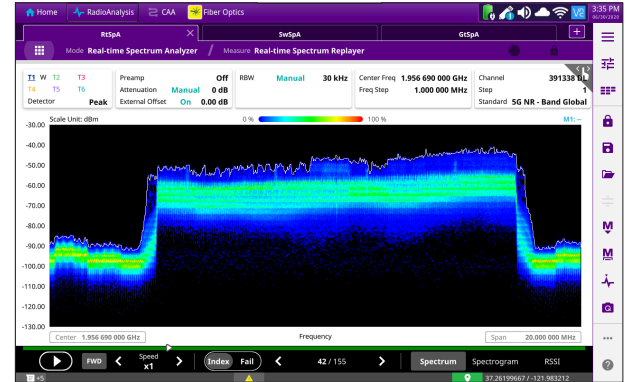

OneAdvisor Spectrum Logging and Replaying

Gated Sweep Spectrum

Interference analysis in TDD signals requires a different measurement technique than conventional spectrum analysis since the uplink and downlink signals are transmitted on the same frequency, but different timeslots.

OneAdvisor performs gated sweep spectrum, effectively conducting spectrum measurements triggered only on the timeslots assigned for uplink transmission.

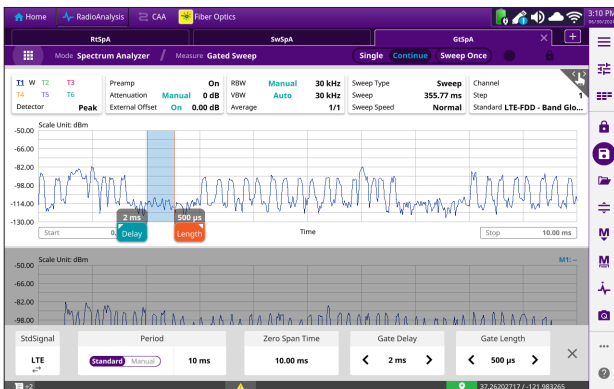

Gated Sweep Spectrum – Gate Time Setting

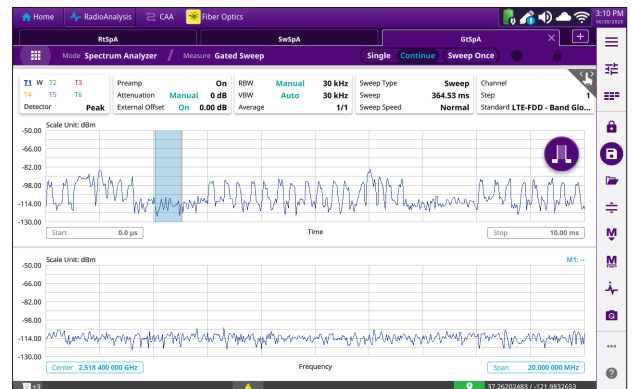

Gated Sweep Spectrum – Spectrum Analysis

Interference Finder

Interference Finder is an automatic triangulation algorithm that uses GPS coordinates to locate the source of interference based on three measurement reference points.

The interference finder automatically calculates the interference locations using an inscribed or circumscribed area based on the measured intersection points.

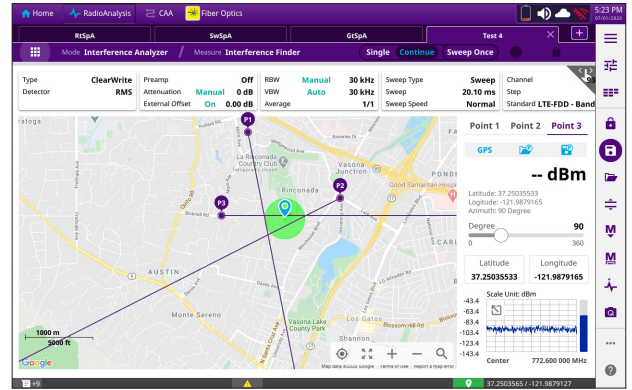

OneAdvisor Interference Finder

Interference Hunting

InterferenceAdvisor™ is a fully automated RF interference hunting solution. Easy to set up and simple to use, it allows one RF engineer to identify and locate an interference source in just hours, simply by following voice prompts on a familiar map-style application on an Android tablet.

The InterferenceAdvisor software communicates with OneAdvisor to retrieve RF power measurements (Peak, RSSI, Channel) and creating a power heat-map during a drive test, and automatically detects the area of incidence with the highest presence of interference, giving optional navigation instructions to the detected location of interference.

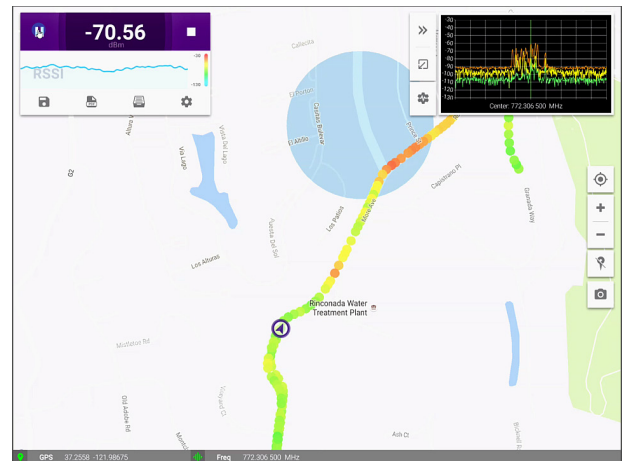
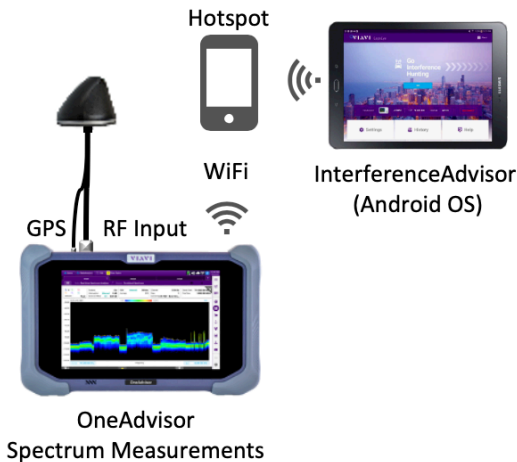

InterferenceAdvisor – Interference Hunting

Cell Site Cable Verification

Cell site infrastructure is composed of fiber links from the switch into the base band unit, also referred as backhaul, as well as fiber links from base band unit to remote radio units, also referred as fronthaul, then the remote radio performs a digital to analog conversion setting the signal into a specific RF carrier with a specific center frequency, bandwidth, and power level through coaxial cables to the transmitting RF antennas.

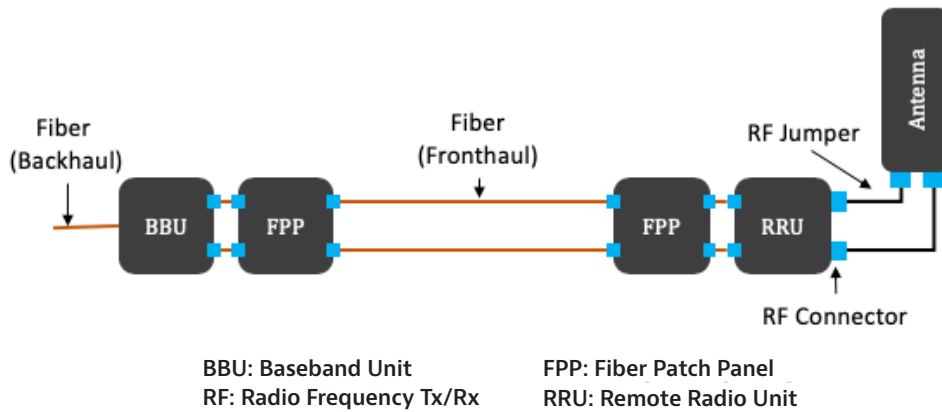

Cell Site Infrastructure – Fiber to the Antenna

Fiber Inspection

The most common cause of signal degradation in an optical transmission system between transmitter, fiber link and receiver, is dirt on fiber connectors, which can get contaminated very easily when the connectors are exposed to the environment.

Therefore, the first step in achieving acceptable insertion- and return-loss in fiber link is by inspecting the fiber connector's end-faces with OneAdvisor equipped with a fiber microscope, capable of performing standard-based PASS/FAIL measurements, collecting results and creating comprehensive close-out reports.



Fiber Inspection

Fiber Characterization

Fiber is more prevalent in cell sites of any kind, from small cells and macro cells, to distributed antenna systems (DAS) and centralized radio access network (C-RAN).

The most effective test to characterize a fiber link is with an optical time-domain reflectometer (OTDR).

OneAdvisor can be equipped with an OTDR module capable of performing fiber testing for single-mode and/or multi-mode fibers in a simple, fast, and cost-effective manner.



Fiber Characterization – OTDR

Cable and Antenna Analysis (CAA)

OneAdvisor can be equipped with a CAA module allowing cell technicians to perform sweep testing for RF cable and antenna verification, including:

- Return Loss and VSWR
- Distance to Fault
- Cable Loss

OneAdvisor’s user-friendly GUI with intuitive PASS/FAIL results instantly identifies problems and enables technicians to easily determine if the cell site meets the coaxial transmission specifications.

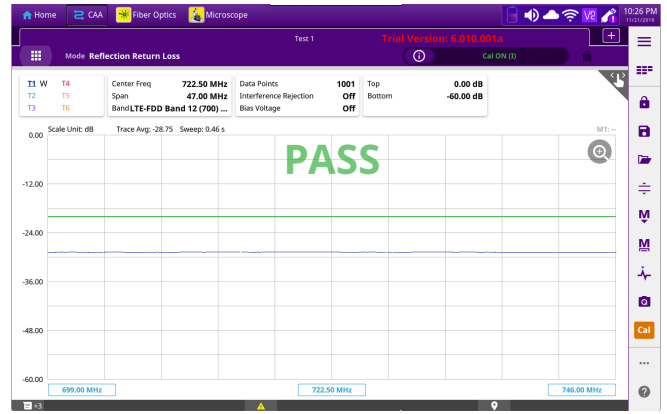

Coaxial Cable and Antenna Analysis – Return Loss

Test Process Automation with Job Manager and StrataSync

VIAVI’s Test Process Automation allows cell technicians to perform installation and maintenance tests with confidence:

- In accordance with mobile operator’s test criteria
- Covering all radios types (LTE and 5G) and topologies (Macro-cell, Small-cell, C-RAN, and/or DAS)
- Automatically uploading test results to the StrataSync cloud with simple PASS/FAIL indicator

Job Manager

VIAVI’s Job Manager automates test processes, offering mobile network operations and cell site construction teams a self-guided test solution, improving efficiency in the field for cell-site installation and maintenance.

Job Manager’s automates the entire process ensuring the proper test sequence is executed according to mobile operator’s requirements, configuration test time is minimized, and results are consistent and consolidated.

Test Type	Reference Info	Status
CAA Reflection VSWR	Sector: Alpha , Band: 600 , Cable: HFC-12D (1/2) , Termination: Load	To Do
CAA DTF VSWR	Sector: Alpha , Band: 600 , Cable: HFC-12D (1/2) , Termination: Load	To Do
Fiber Inspection	Cable: Alpha Sector , Connector: DL	To Do
CAA Reflection Return Loss	Sector: Beta , Band: 600 , Cable: HFC-12D (1/2) , Termination: Load	To Do
CAA DTF Return Loss	Sector: Beta , Band: 600 , Cable: HFC-12D (1/2) , Termination: Load	To Do

Test Type	Reference Info	File	Verdict
RT Persistent Spectrum		Test1.png	N/A
CAA Reflection VSWR		t1.png	N/A
CAA Reflection VSWR		t2.png	N/A
RT Persistent Spectrum		Test2.png	N/A
RF Sweep Tuned Spectrum		Test3.png	N/A
RT Persistent Spectrum		Test4.png	N/A
RT Persistent Spectrum		Test5.png	N/A
RT Persistent Spectrum		Test6.png	N/A
RT Persistent Spectrum		TEST-A.png	N/A
RT Persistent Spectrum		TEST-B.png	N/A
CAA Reflection VSWR		CAA-1.png	N/A

OneAdvisor Job Manager

StrataSync

StrataSync is VIAVI's cloud-hosted system that provides a centralized management of test solutions including; test set management, test configurations, data management, and test results.



Stratasync is designed to eliminate email dispatches, manual test procedures, manual report consolidation, test solution availability and test devices that need calibration.

The screenshot shows the StrataSync web interface with a table of assets. The table has columns for Asset class, Asset Type, Model, Serial No, Tech ID, Asset Status, Firmware, and HW Version. There are 12 records displayed.

Asset class	Asset Type	Model	Serial No	Tech ID	Asset Status	Firmware	HW Version
Syncable	CellAdvisor CAA	JD7Z3C	BEF31069	rfest1234	Active	1.088.001	1.000
Syncable	CellAdvisor BSA	JD745B	EFA41184	rfest1234	Active	3.110.023	4.000
Syncable	CellAdvisor BSA	JD745B	GAH41868	rfest1234	Active	3.110.025	4.000
Syncable	CellAdvisor 5G	CA5000	CASN003	rfest1234	Active	5.055.025v-1	004
Module	CellAdvisor 5G-module	Advisor SHIM	WHAK0041490005	rfest1234	Active		004
Module	CellAdvisor 5G-module	4136 MA3FCO	00791	rfest1234	Active		16
Module	CellAdvisor 5G-module	Advisor SHIM	WHAK0052090001	rfest1234	Active		005
Module	CellAdvisor 5G-module	4146 QUAD	34208	rfest1234	Active		27
Syncable	ONA-800	ONA-800	WMSR0011600010	rfest1234	Active	1.2.0-79d5204	008
Module	ONA-800-module	4146 QUAD	36061	rfest1234	Active		27
Module	ONA-800-module	IDB-SA	WMSG0042000020	rfest1234	Active		004
Module	ONA-800-module	ONA-800A-DISPL	WMSG0021600010	rfest1234	Active		002

StrataSync – Asset Management



Faster Work Speed

Eliminate wasted time trying to remember which tests to run and how to run them

Greater Consistency

Drive consistent, repeatable results, regardless of technician skill or experience

Lower Training Costs

New technicians get up to speed quickly with easy-to-follow prompts

Peace of Mind

Test results automatically saved to StrataSync cloud



Contact Us **+1 844 GO VIAVI**
(+1 844 468 4284)

To reach the VIAVI office nearest you, visit viavisolutions.com/contact

emitec
industrial

Emitec Messtechnik AG
Birkenstrasse 47
6343 Rotkreuz

+41 41 748 60 10
info@emitec.ch
www.emitec-industrial.ch

Emitec Group
#1 in Test & Measurement, worldwide.