

User's manual FLIR GF3xx series



emitec
industrial

Emitec Messtechnik AG
Birkenstrasse 47
6343 Rotkreuz

+41 41 748 60 10
info@emitec.ch
www.emitec-industrial.ch



Emitec Group 
#1 in Test & Measurement, worldwide.

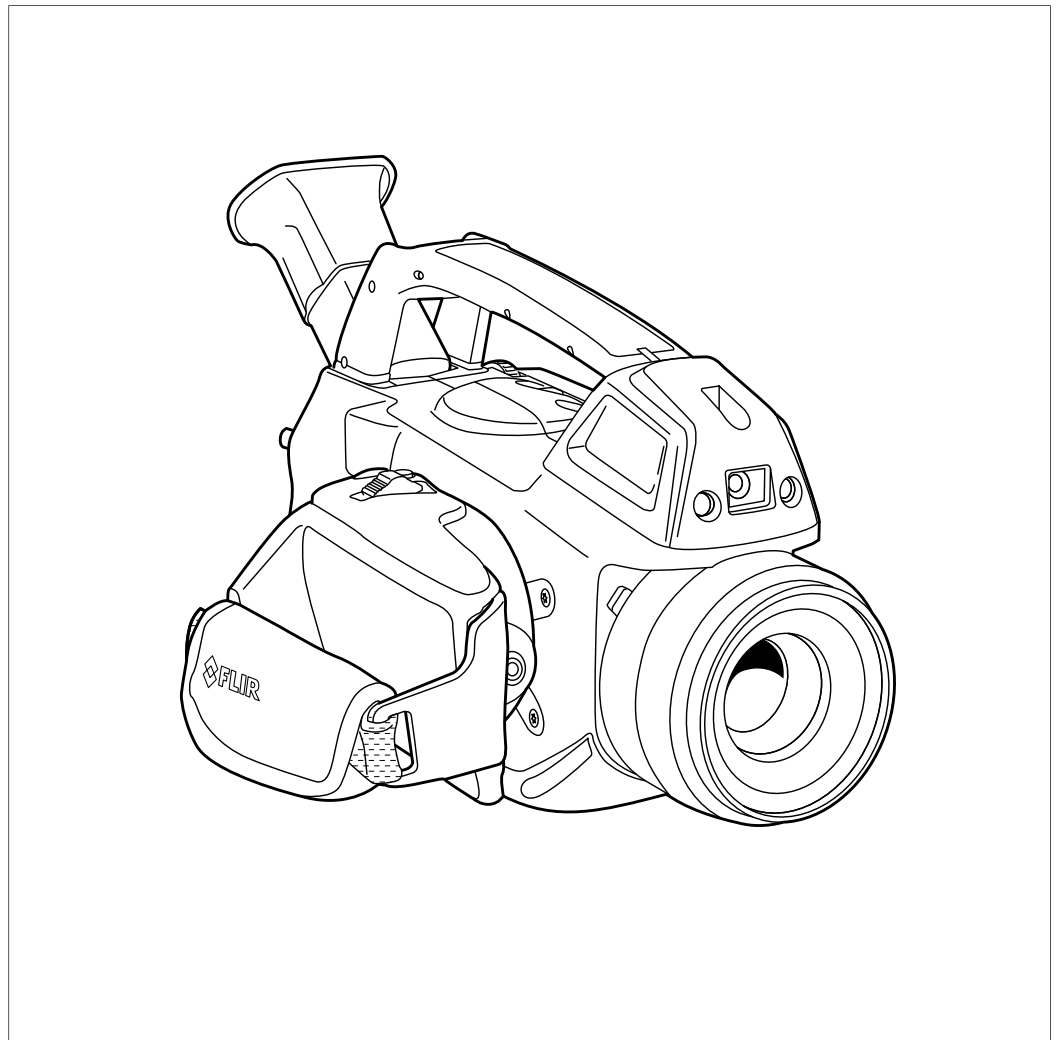



User's manual FLIR GF3xx series



Table of contents

1	Disclaimers	1
1.1	Legal disclaimer	1
1.2	U.S. Government Regulations	1
1.3	Level 1 statement	1
1.4	Copyright	2
1.5	Quality assurance	2
1.6	Patents	2
1.7	EULA Terms	2
1.8	EULA Terms	3
2	Safety information	5
3	Notice to user	10
3.1	User-to-user forums	10
3.2	Calibration	10
3.3	Accuracy	10
3.4	Disposal of electronic waste	10
3.5	Training	10
3.6	Documentation updates	11
3.7	Note about authoritative versions	11
4	Customer help	12
4.1	General	12
4.2	Submitting a question	12
4.3	Downloads	13
5	Important note about training and applications	14
5.1	General	14
6	List of accessories and services	15
7	Introduction	17
7.1	FLIR GF300	17
7.1.1	Optical gas imaging of methane and other volatile organic compounds (VOCs)	17
7.1.2	Benefits	17
7.2	FLIR GF304	17
7.2.1	Optical gas imaging of refrigerant gases	17
7.2.2	Benefits	17
7.3	FLIR GF306	18
7.3.1	Optical gas imaging especially of SF6 and ammonia	18
7.3.2	Benefits	18
7.4	FLIR GF309	18
7.4.1	IR camera for furnace and high temperature inspection	18
7.4.2	Benefits	19
7.5	FLIR GF320	19
7.5.1	Optical gas imaging of methane and other volatile organic compounds (VOCs)	19
7.5.2	Benefits	19
7.6	FLIR GF335	20
7.6.1	Benefits	20
7.7	FLIR GF343	20
7.7.1	The new FLIR GF343 is an optical gas camera for visualizing carbon dioxide (CO ₂)	20
7.7.2	Main applications	20

Table of contents

7.8	FLIR GF346.....	21
7.8.1	Optical gas imaging especially of carbon monoxide (CO) and other harmful gases	21
7.8.2	Benefits	21
8	Example images.....	22
8.1	General	22
8.2	Images	22
9	Quick Start Guide	23
9.1	Detecting a temperature	23
9.1.1	Procedure	23
9.1.2	Related topics	24
9.2	Detecting a gas leak	24
9.2.1	Procedure	24
9.2.2	Related topics	25
10	FLIR GF3xx series series general instrument check.....	26
11	A note about ergonomics	27
11.1	General	27
11.2	Figure	27
11.3	Related topics.....	28
12	Camera parts	29
12.1	View from the left	29
12.1.1	Figure.....	29
12.1.2	Explanation.....	29
12.2	View from the right	30
12.2.1	Figure.....	30
12.2.2	Explanation.....	30
12.3	View from the rear	31
12.3.1	Figure.....	31
12.3.2	Explanation.....	31
12.4	Battery condition LED indicator	32
12.4.1	Figure.....	32
12.4.2	Explanation.....	32
12.5	Power LED indicator	32
12.5.1	Figure.....	32
12.5.2	Explanation.....	33
12.6	Laser pointer	33
12.6.1	General.....	33
12.6.2	Figure.....	33
12.6.3	Laser warning label.....	33
12.6.4	Laser rules and regulations	33
13	Screen elements	34
13.1	Mode selector	34
13.1.1	Figure.....	34
13.1.2	Explanation.....	34
13.2	Result table and measurement tools	34
13.2.1	Figure.....	34
13.2.2	Explanation.....	34
13.3	Toolbox, indicators, and other objects.....	35
13.3.1	Figure.....	35
13.3.2	Explanation.....	35

14	Achieving a good image	36
14.1	General	36
14.2	Adjusting the infrared camera focus manually	36
14.2.1	Figure	36
14.2.2	Procedure	36
14.3	Adjusting the infrared camera focus	37
14.3.1	Figure	37
14.3.2	Procedure	37
14.4	Adjusting an image	37
14.4.1	General	37
14.4.2	Explanation of the adjustment methods	37
14.4.3	Procedure (<i>Auto</i>)	37
14.4.4	Figure	38
14.4.5	Procedure (<i>HSM</i>)	38
14.4.6	Procedure (<i>Manual</i>)	38
14.5	Selecting a suitable temperature range	38
14.5.1	About temperature ranges	38
14.5.2	Understanding the temperature scale	39
14.5.3	Changing the temperature range	40
14.6	Selecting a suitable color palette	40
14.6.1	Procedure	40
14.7	Enabling or disabling histogram mode	40
14.7.1	General	40
14.7.2	Procedure	40
14.8	Enabling or disabling inverted color palette	41
14.8.1	Procedure	41
14.9	Changing object parameters	41
14.9.1	General	41
14.9.2	Types of parameters	41
14.9.3	Recommended values	41
14.9.4	Procedure	42
14.9.5	Related topics	42
15	Connecting external devices	43
15.1	General	43
15.2	Related topics	43
15.3	Connecting devices to the rear connectors	43
15.3.1	Figure	43
15.3.2	Explanation	43
15.3.3	Figure	44
15.3.4	Explanation	44
15.4	Inserting SD Memory Cards	44
15.4.1	Figure	44
15.4.2	Explanation	44
15.4.3	Formatting memory cards	45
16	Handling the camera	46
16.1	Charging the camera battery	46
16.1.1	Charging the battery using the power supply cable	46
16.1.2	Charging the battery using the stand-alone battery charger	46
16.2	Installing and removing the camera battery	47
16.2.1	Installing the battery	47

Table of contents

16.2.2	Removing the battery	48
16.3	Turning on the camera	49
16.3.1	Procedure	49
16.4	Turning off the camera	49
16.4.1	Procedure	49
16.5	Adjusting the viewing angle of the viewfinder	49
16.5.1	General.....	49
16.5.2	Figure.....	49
16.5.3	Procedure	49
16.6	Adjusting the viewfinder's dioptic correction	50
16.6.1	General.....	50
16.6.2	Figure.....	50
16.6.3	Procedure	50
16.7	Adjusting the camera grip	50
16.7.1	General.....	50
16.7.2	Figure.....	51
16.7.3	Procedure	51
16.8	Opening the display.....	51
16.8.1	Figure.....	51
16.9	Adjusting the viewing angle of the display.....	52
16.9.1	General.....	52
16.9.2	Figure.....	52
16.9.3	Procedure	52
16.10	Installing an infrared lens	52
16.10.1	Procedure	52
16.11	Removing an infrared lens	53
16.11.1	Procedure	53
16.12	Mounting the heatshield	54
16.12.1	General.....	54
16.12.2	Procedure	54
16.13	Adjusting the infrared camera focus manually	56
16.13.1	Figure.....	56
16.13.2	Procedure	56
16.14	Adjusting the infrared camera focus	57
16.14.1	Figure.....	57
16.14.2	Procedure	57
16.15	Autofocusing the infrared camera and the digital camera	58
16.15.1	Figure.....	58
16.15.2	Procedure	58
16.16	Operating the laser pointer.....	59
16.16.1	Figure.....	59
16.16.2	Procedure	59
16.16.3	Laser warning label.....	59
16.17	Using the zoom function	59
16.17.1	General.....	59
16.17.2	Procedure	59
17	Working with views and images.....	60
17.1	Saving infrared images.....	60
17.1.1	General.....	60
17.1.2	Image capacity	60

Table of contents

17.1.3	Saving an infrared image directly to an SD Memory Card.....	60
17.1.4	Previewing and saving an infrared image to an SD Memory Card	60
17.2	Opening an image.....	61
17.2.1	General.....	61
17.2.2	Procedure	61
17.3	Changing settings related to image presentation.....	61
17.3.1	General.....	61
17.3.2	Procedure	62
17.4	Editing a saved image.....	62
17.4.1	General.....	62
17.4.2	Procedure	62
17.5	Deleting a file	63
17.5.1	Procedure	63
18	Working with measurement tools	64
18.1	Laying out a measurement tool	64
18.1.1	General.....	64
18.1.2	Procedure	64
18.2	Moving or resizing a measurement tool.....	64
18.2.1	General.....	64
18.2.2	Procedure	64
18.3	Creating & setting up a difference calculation	64
18.3.1	General.....	64
18.3.2	Procedure	65
18.4	Changing object parameters	65
18.4.1	General.....	65
18.4.2	Types of parameters	65
18.4.3	Recommended values.....	66
18.4.4	Procedure	66
18.4.5	Related topics	67
19	Programming the camera	68
19.1	General	68
19.2	Procedure	68
20	Recording video clips	69
20.1	General	69
20.2	Procedure	69
21	Changing settings	70
21.1	General	70
21.2	Procedure	70
21.3	Connecting the camera using a peer-to-peer (ad hoc) WLAN network	70
21.3.1	General.....	70
21.3.2	Procedure	70
21.3.3	Related topics	71
21.4	Connecting the camera using a infrastructure WLAN network	71
21.4.1	General.....	71
21.4.2	Procedure	71
21.4.3	Related topics	71
21.5	Changing Wi-Fi settings	71
21.5.1	General.....	71

Table of contents

	21.5.2 Procedure	71
	21.5.3 Related topics	72
22	Technical data	73
22.1	Online field-of-view calculator	73
22.2	Note about technical data	73
22.3	Note about authoritative versions.....	74
22.4	FLIR GF300 14.5°	75
22.5	FLIR GF300 14.5° Fixed lens.....	80
22.6	FLIR GF300 24°	85
22.7	FLIR GF300 24° Fixed lens	90
22.8	FLIR GF304 14.5°	95
22.9	FLIR GF304 14.5° Fixed lens.....	101
22.10	FLIR GF304 24°	106
22.11	FLIR GF304 24° Fixed lens	112
22.12	FLIR GF306 14.5°	117
22.13	FLIR GF306 14.5° Fixed lens.....	123
22.14	FLIR GF306 24°	129
22.15	FLIR GF306 24° Fixed lens	135
22.16	FLIR GF309 14.5°	141
22.17	FLIR GF309 14.5° Fixed lens.....	147
22.18	FLIR GF309 24°	152
22.19	FLIR GF309 24° Fixed lens	158
22.20	FLIR GF320 14.5°	163
22.21	FLIR GF320 14.5° Fixed lens.....	169
22.22	FLIR GF320 24°	175
22.23	FLIR GF320 24° Fixed lens	181
22.24	FLIR GF335 24°	187
22.25	FLIR GF343 24° Fixed lens	192
22.26	FLIR GF346 14.5°	197
22.27	FLIR GF346 14.5° Fixed lens.....	203
22.28	FLIR GF346 24°	209
22.29	FLIR GF346 24° Fixed lens	215
23	Mechanical drawings	221
24	CE Declaration of conformity	227
25	Cleaning the camera	229
25.1	Camera housing, cables, and other items.....	229
25.1.1	Liquids.....	229
25.1.2	Equipment	229
25.1.3	Procedure	229
25.2	Infrared lens	229
25.2.1	Liquids.....	229
25.2.2	Equipment	229
25.2.3	Procedure	229
26	Cooler maintenance.....	231
26.1	General	231
26.2	Signs to watch for	231
27	Detectable gases.....	232
27.1	General	232
27.2	Gases that can be detected by FLIR GF300.....	232
27.3	Coolants that can be detected by FLIR GF304	235

Table of contents

27.4	Gases that can be detected by FLIR GF306.....	235
27.5	Gases that can be detected by FLIR GF320.....	239
27.6	Gases that can be detected by FLIR GF343.....	242
27.7	Gases that can be detected by FLIR GF346.....	242
28	Why do some gases absorb infrared energy?	246
29	About FLIR Systems	249
29.1	More than just an infrared camera	250
29.2	Sharing our knowledge	251
29.3	Supporting our customers.....	251
30	Terms, laws, and definitions.....	252
31	About calibration.....	254
31.1	Introduction	254
31.2	Definition—what is calibration?	254
31.3	Camera calibration at FLIR Systems	254
31.4	The differences between a calibration performed by a user and that performed directly at FLIR Systems.....	255
31.5	Calibration, verification and adjustment.....	255
31.6	Non-uniformity correction.....	256
31.7	Thermal image adjustment (thermal tuning)	256
32	Thermographic measurement techniques	257
32.1	Introduction	257
32.2	Emissivity.....	257
32.2.1	Finding the emissivity of a sample.....	257
32.3	Reflected apparent temperature	261
32.4	Distance	261
32.5	Relative humidity	261
32.6	Other parameters.....	261
33	History of infrared technology.....	262
34	Theory of thermography.....	265
34.1	Introduction	265
34.2	The electromagnetic spectrum.....	265
34.3	Blackbody radiation.....	266
34.3.1	Planck's law	267
34.3.2	Wien's displacement law.....	268
34.3.3	Stefan-Boltzmann's law	269
34.3.4	Non-blackbody emitters	270
34.4	Infrared semi-transparent materials.....	272
35	The measurement formula.....	273
36	Emissivity tables	277
36.1	References.....	277
36.2	Tables	277

Disclaimers

1.1 Legal disclaimer

All products manufactured by FLIR Systems are warranted against defective materials and workmanship for a period of one (1) year from the delivery date of the original purchase, provided such products have been under normal storage, use and service, and in accordance with FLIR Systems instruction.

Uncooled handheld infrared cameras manufactured by FLIR Systems are warranted against defective materials and workmanship for a period of two (2) years from the delivery date of the original purchase, provided such products have been under normal storage, use and service, and in accordance with FLIR Systems instruction, and provided that the camera has been registered within 60 days of original purchase.

Detectors for uncooled handheld infrared cameras manufactured by FLIR Systems are warranted against defective materials and workmanship for a period of ten (10) years from the delivery date of the original purchase, provided such products have been under normal storage, use and service, and in accordance with FLIR Systems instruction, and provided that the camera has been registered within 60 days of original purchase.

Products which are not manufactured by FLIR Systems but included in systems delivered by FLIR Systems to the original purchaser, carry the warranty, if any, of the particular supplier only. FLIR Systems has no responsibility whatsoever for such products.

The warranty extends only to the original purchaser and is not transferable. It is not applicable to any product which has been subjected to misuse, neglect, accident or abnormal conditions of operation. Expendable parts are excluded from the warranty.

In the case of a defect in a product covered by this warranty the product must not be further used in order to prevent additional damage. The purchaser shall promptly report any defect to FLIR Systems or this warranty will not apply.

FLIR Systems will, at its option, repair or replace any such defective product free of charge if, upon inspection, it proves to be defective in material or workmanship and provided that it is returned to FLIR Systems within the said one-year period.

FLIR Systems has no other obligation or liability for defects than those set forth above.

No other warranty is expressed or implied. FLIR Systems specifically disclaims the implied warranties of merchantability and fitness for a particular purpose.

FLIR Systems shall not be liable for any direct, indirect, special, incidental or consequential loss or damage, whether based on contract, tort or any other legal theory.

This warranty shall be governed by Swedish law.

Any dispute, controversy or claim arising out of or in connection with this warranty, shall be finally settled by arbitration in accordance with the Rules of the Arbitration Institute of the Stockholm Chamber of Commerce. The place of arbitration shall be Stockholm. The language to be used in the arbitral proceedings shall be English.

1.2 U.S. Government Regulations

This product may be subject to U.S. Export Regulations. Please send any inquiries to exportquestions@flir.com.

1.3 Level 1 statement

Applicability: Flir GF3xx.

This document is controlled to Flir Technology Level 1. The information contained in this document pertains to a defense article controlled for export by the International Traffic in

Arms Regulations (ITAR). Flir trade secrets contained herein are subject to disclosure restrictions as a matter of law. Diversion contrary to US law is prohibited. US Government authorization for public release has been obtained from the Office of Security Review, authorization No. 10-S-2672. Additional US Department of State authorization is not required prior to export or transfer to foreign persons or parties, unless otherwise prohibited.

1.4 Copyright

© 2016, FLIR Systems, Inc. All rights reserved worldwide. No parts of the software including source code may be reproduced, transmitted, transcribed or translated into any language or computer language in any form or by any means, electronic, magnetic, optical, manual or otherwise, without the prior written permission of FLIR Systems.

The documentation must not, in whole or part, be copied, photocopied, reproduced, translated or transmitted to any electronic medium or machine readable form without prior consent, in writing, from FLIR Systems.

Names and marks appearing on the products herein are either registered trademarks or trademarks of FLIR Systems and/or its subsidiaries. All other trademarks, trade names or company names referenced herein are used for identification only and are the property of their respective owners.

1.5 Quality assurance

The Quality Management System under which these products are developed and manufactured has been certified in accordance with the ISO 9001 standard.

FLIR Systems is committed to a policy of continuous development; therefore we reserve the right to make changes and improvements on any of the products without prior notice.

1.6 Patents

000439161; 000653423; 000726344; 000859020; 001707738; 001707746; 001707787; 001776519; 001954074; 002021543; 002021543-0002; 002058180; 002249953; 002531178; 002816785; 002816793; 011200326; 014347553; 057692; 061609; 07002405; 100414275; 101796816; 101796817; 101796818; 102334141; 1062100; 11063060001; 11517895; 1226865; 12300216; 12300224; 1285345; 1299699; 1325808; 1336775; 1391114; 1402918; 1404291; 1411581; 1415075; 1421497; 1458284; 1678485; 1732314; 17399650; 1880950; 1886650; 2007301511414; 2007303395047; 2008301285812; 2009301900619; 20100060357; 2010301761271; 2010301761303; 2010301761572; 2010305959313; 2011304423549; 2012304717443; 2012306207318; 2013302676195; 2015202354035; 2015304259171; 204465713; 204967995; 2106017; 2107799; 2115696; 2172004; 2315433; 2381417; 2794760001; 3006596; 3006597; 303330211; 4358936; 483782; 484155; 4889913; 4937897; 4995790001; 5177595; 540838; 579475; 584755; 599392; 60122153; 6020040116815; 602006006500.0; 6020080347796; 6020110003453; 615113; 615116; 664580; 664581; 665004; 665440; 67023029; 6707044; 677298; 68657; 69036179; 70022216; 70028915; 70028923; 70057990; 7034300; 710424; 7110035; 7154093; 7157705; 718801; 723605; 7237946; 7312822; 7332716; 7336823; 734803; 7544944; 7606484; 7634157; 7667198; 7809258; 7826736; 8018649; 8153971; 8212210; 8289372; 8340414; 8354639; 8384783; 8520970; 8565547; 8595689; 8599262; 8654239; 8680468; 8803093; 8823803; 8853631; 8933403; 9171361; 9191583; 9279728; 9280812; 9338352; 9423940; 9471970; 9595087; D549758.

1.7 EULA Terms

- You have acquired a device ("INFRARED CAMERA") that includes software licensed by FLIR Systems AB from Microsoft Licensing, GP or its affiliates ("MS"). Those installed software products of MS origin, as well as associated media, printed materials, and

“online” or electronic documentation (“SOFTWARE”) are protected by international intellectual property laws and treaties. The SOFTWARE is licensed, not sold. All rights reserved.

- IF YOU DO NOT AGREE TO THIS END USER LICENSE AGREEMENT (“EULA”), DO NOT USE THE DEVICE OR COPY THE SOFTWARE. INSTEAD, PROMPTLY CONTACT FLIR Systems AB FOR INSTRUCTIONS ON RETURN OF THE UNUSED DEVICE(S) FOR A REFUND. **ANY USE OF THE SOFTWARE, INCLUDING BUT NOT LIMITED TO USE ON THE DEVICE, WILL CONSTITUTE YOUR AGREEMENT TO THIS EULA (OR RATIFICATION OF ANY PREVIOUS CONSENT).**
- **GRANT OF SOFTWARE LICENSE.** This EULA grants you the following license:
 - You may use the SOFTWARE only on the DEVICE.
 - **NOT FAULT TOLERANT.** THE SOFTWARE IS NOT FAULT TOLERANT. FLIR Systems AB HAS INDEPENDENTLY DETERMINED HOW TO USE THE SOFTWARE IN THE DEVICE, AND MS HAS RELIED UPON FLIR Systems AB TO CONDUCT SUFFICIENT TESTING TO DETERMINE THAT THE SOFTWARE IS SUITABLE FOR SUCH USE.
 - **NO WARRANTIES FOR THE SOFTWARE.** THE SOFTWARE is provided “AS IS” and with all faults. THE ENTIRE RISK AS TO SATISFACTORY QUALITY, PERFORMANCE, ACCURACY, AND EFFORT (INCLUDING LACK OF NEGLIGENCE) IS WITH YOU. ALSO, THERE IS NO WARRANTY AGAINST INTERFERENCE WITH YOUR ENJOYMENT OF THE SOFTWARE OR AGAINST INFRINGEMENT. **IF YOU HAVE RECEIVED ANY WARRANTIES REGARDING THE DEVICE OR THE SOFTWARE, THOSE WARRANTIES DO NOT ORIGINATE FROM, AND ARE NOT BINDING ON, MS.**
 - No Liability for Certain Damages. **EXCEPT AS PROHIBITED BY LAW, MS SHALL HAVE NO LIABILITY FOR ANY INDIRECT, SPECIAL, CONSEQUENTIAL OR INCIDENTAL DAMAGES ARISING FROM OR IN CONNECTION WITH THE USE OR PERFORMANCE OF THE SOFTWARE. THIS LIMITATION SHALL APPLY EVEN IF ANY REMEDY FAILS OF ITS ESSENTIAL PURPOSE. IN NO EVENT SHALL MS BE LIABLE FOR ANY AMOUNT IN EXCESS OF U.S. TWO HUNDRED FIFTY DOLLARS (U.S.\$250.00).**
 - **Limitations on Reverse Engineering, Decompilation, and Disassembly.** You may not reverse engineer, decompile, or disassemble the SOFTWARE, except and only to the extent that such activity is expressly permitted by applicable law notwithstanding this limitation.
 - **SOFTWARE TRANSFER ALLOWED BUT WITH RESTRICTIONS.** You may permanently transfer rights under this EULA only as part of a permanent sale or transfer of the Device, and only if the recipient agrees to this EULA. If the SOFTWARE is an upgrade, any transfer must also include all prior versions of the SOFTWARE.
 - **EXPORT RESTRICTIONS.** You acknowledge that SOFTWARE is subject to U.S. export jurisdiction. You agree to comply with all applicable international and national laws that apply to the SOFTWARE, including the U.S. Export Administration Regulations, as well as end-user, end-use and destination restrictions issued by U.S. and other governments. For additional information see <http://www.microsoft.com/exporting/>.

1.8 EULA Terms

Qt4 Core and Qt4 GUI, Copyright ©2013 Nokia Corporation and FLIR Systems AB. This Qt library is a free software; you can redistribute it and/or modify it under the terms of the GNU Lesser General Public License as published by the Free Software Foundation; either version 2.1 of the License, or (at your option) any later version. This library is distributed in the hope that it will be useful, but WITHOUT ANY WARRANTY; without even the implied warranty of MERCHANTABILITY or FITNESS FOR A PARTICULAR PURPOSE. See the GNU Lesser General Public License, <http://www.gnu.org/licenses/lgpl-2.1.html>. The

source code for the libraries Qt4 Core and Qt4 GUI may be requested from FLIR Systems AB.

Safety information



WARNING

Applicability: Class A digital devices.

This equipment generates, uses, and can radiate radio frequency energy and if not installed and used in accordance with the instruction manual, may cause interference to radio communications. It has been tested and found to comply with the limits for a Class A computing device pursuant to Subpart J of Part 15 of FCC Rules, which are designed to provide reasonable protection against such interference when operated in a commercial environment. Operation of this equipment in a residential area is likely to cause interference in which case the user at his own expense will be required to take whatever measures may be required to correct the interference.



WARNING

Applicability: Class B digital devices.

This equipment has been tested and found to comply with the limits for a Class B digital device, pursuant to Part 15 of the FCC Rules. These limits are designed to provide reasonable protection against harmful interference in a residential installation. This equipment generates, uses and can radiate radio frequency energy and, if not installed and used in accordance with the instructions, may cause harmful interference to radio communications. However, there is no guarantee that interference will not occur in a particular installation. If this equipment does cause harmful interference to radio or television reception, which can be determined by turning the equipment off and on, the user is encouraged to try to correct the interference by one or more of the following measures:

- Reorient or relocate the receiving antenna.
- Increase the separation between the equipment and receiver.
- Connect the equipment into an outlet on a circuit different from that to which the receiver is connected.
- Consult the dealer or an experienced radio/TV technician for help.



WARNING

Applicability: Digital devices subject to 15.19/RSS-210.

NOTICE: This device complies with Part 15 of the FCC Rules and with RSS-210 of Industry Canada. Operation is subject to the following two conditions:

1. this device may not cause harmful interference, and
2. this device must accept any interference received, including interference that may cause undesired operation.



WARNING

Applicability: Digital devices subject to 15.21.

NOTICE: Changes or modifications made to this equipment not expressly approved by FLIR Systems may void the FCC authorization to operate this equipment.



WARNING

Applicability: Digital devices subject to 2.1091/2.1093/OET Bulletin 65.

Radiofrequency radiation exposure Information: The radiated output power of the device is below the FCC/IC radio frequency exposure limits. Nevertheless, the device shall be used in such a manner that the potential for human contact during normal operation is minimized.



WARNING

Applicability: Cameras with one or more laser pointers.

Do not look directly into the laser beam. The laser beam can cause eye irritation.

 **WARNING**

Applicability: Cameras with one or more batteries.

Do not disassemble or do a modification to the battery. The battery contains safety and protection devices which, if damage occurs, can cause the battery to become hot, or cause an explosion or an ignition.

 **WARNING**

Applicability: Cameras with one or more batteries.

If there is a leak from the battery and you get the fluid in your eyes, do not rub your eyes. Flush well with water and immediately get medical care. The battery fluid can cause injury to your eyes if you do not do this.

 **WARNING**

Applicability: Cameras with one or more batteries.

Do not continue to charge the battery if it does not become charged in the specified charging time. If you continue to charge the battery, it can become hot and cause an explosion or ignition. Injury to persons can occur.

 **WARNING**

Applicability: Cameras with one or more batteries.

Only use the correct equipment to remove the electrical power from the battery. If you do not use the correct equipment, you can decrease the performance or the life cycle of the battery. If you do not use the correct equipment, an incorrect flow of current to the battery can occur. This can cause the battery to become hot, or cause an explosion. Injury to persons can occur.

 **WARNING**

Make sure that you read all applicable MSDS (Material Safety Data Sheets) and warning labels on containers before you use a liquid. The liquids can be dangerous. Injury to persons can occur.

 **CAUTION**

Do not point the infrared camera (with or without the lens cover) at strong energy sources, for example, devices that cause laser radiation, or the sun. This can have an unwanted effect on the accuracy of the camera. It can also cause damage to the detector in the camera.

 **CAUTION**

Do not use the camera in temperatures more than +50°C (+122°F), unless other information is specified in the user documentation or technical data. High temperatures can cause damage to the camera.

 **CAUTION**

Applicability: Cameras with one or more laser pointers.

To prevent damage, put the protective cap on the laser pointer when you do not operate the laser pointer. Damage to the laser pointer can occur if you do not do this.

 **CAUTION**

Applicability: Cameras with one or more batteries.

Do not attach the batteries directly to a car's cigarette lighter socket, unless FLIR Systems supplies a specific adapter to connect the batteries to a cigarette lighter socket. Damage to the batteries can occur.

 **CAUTION**

Applicability: Cameras with one or more batteries.

Do not connect the positive terminal and the negative terminal of the battery to each other with a metal object (such as wire). Damage to the batteries can occur.

 **CAUTION**

Applicability: Cameras with one or more batteries.

Do not get water or salt water on the battery, or permit the battery to become wet. Damage to the batteries can occur.

 **CAUTION**

Applicability: Cameras with one or more batteries.

Do not make holes in the battery with objects. Damage to the battery can occur.

 **CAUTION**

Applicability: Cameras with one or more batteries.

Do not hit the battery with a hammer. Damage to the battery can occur.

 **CAUTION**

Applicability: Cameras with one or more batteries.

Do not put your foot on the battery, hit it or cause shocks to it. Damage to the battery can occur.

 **CAUTION**

Applicability: Cameras with one or more batteries.

Do not put the batteries in or near a fire, or into direct sunlight. When the battery becomes hot, the built-in safety equipment becomes energized and can stop the battery charging procedure. If the battery becomes hot, damage can occur to the safety equipment and this can cause more heat, damage or ignition of the battery.

 **CAUTION**

Applicability: Cameras with one or more batteries.

Do not put the battery on a fire or increase the temperature of the battery with heat. Damage to the battery and injury to persons can occur.

 **CAUTION**

Applicability: Cameras with one or more batteries.

Do not put the battery on or near fires, stoves, or other high-temperature locations. Damage to the battery and injury to persons can occur.

 **CAUTION**

Applicability: Cameras with one or more batteries.

Do not solder directly onto the battery. Damage to the battery can occur.

 **CAUTION**

Applicability: Cameras with one or more batteries.

Do not use the battery if, when you use, charge, or put the battery in storage, there is an unusual smell from the battery, the battery feels hot, changes color, changes shape, or is in an unusual condition. Speak with your sales office if one or more of these problems occurs. Damage to the battery and injury to persons can occur.

 **CAUTION**

Applicability: Cameras with one or more batteries.

Only use a specified battery charger when you charge the battery. Damage to the battery can occur if you do not do this.

 **CAUTION**

Applicability: Cameras with one or more batteries.

Only use a specified battery for the camera. Damage to the camera and the battery can occur if you do not do this.

 **CAUTION**

Applicability: Cameras with one or more batteries.

The temperature range through which you can charge the battery is 0°C to +45°C (+32°F to +113°F). If you charge the battery at temperatures out of this range, it can cause the battery to become hot or to break. It can also decrease the performance or the life cycle of the battery.

 **CAUTION**

Applicability: Cameras with one or more batteries.

The temperature range through which you can remove the electrical power from the battery is -15°C to +50°C (+5°F to +122°F), unless other information is specified in the user documentation or technical data. If you operate the battery out of this temperature range, it can decrease the performance or the life cycle of the battery.

 **CAUTION**

Applicability: Cameras with one or more batteries.

When the battery is worn, apply insulation to the terminals with adhesive tape or equivalent materials before you discard it. Damage to the battery and injury to persons can occur if you do not do this.

 **CAUTION**

Applicability: Cameras with one or more batteries.

Remove any water or moisture on the battery before you install it. Damage to the battery can occur if you do not do this.

 **CAUTION**

Do not apply solvents or equivalent liquids to the camera, the cables, or other items. Damage to the battery and injury to persons can occur.

 **CAUTION**

Be careful when you clean the infrared lens. The lens has an anti-reflective coating which is easily damaged. Damage to the infrared lens can occur.

 **CAUTION**

Do not use too much force to clean the infrared lens. This can cause damage to the anti-reflective coating.

 **CAUTION**

Applicability: Cameras with a heatshield.

When you operate the camera in high-temperature conditions, you must install a heatshield on the camera. If you use the camera in high-temperature conditions without a heatshield, damage to the camera can occur.

Note The encapsulation rating is only applicable when all the openings on the camera are sealed with their correct covers, hatches, or caps. This includes the compartments for data storage, batteries, and connectors.

 **CAUTION**

Applicability: FLIR GF309.

The exceptionally wide temperature range of the FLIR GF309 infrared camera is designed for performing highly accurate electrical and mechanical inspections and can also “see through flames” for inspecting gas-fired furnaces, chemical heaters and coal-fired boilers. **IN ORDER TO DERIVE ACCURATE TEMPERATURE MEASUREMENTS IN THESE ENVIRONMENTS THE FLIR GF309 OPERATOR MUST HAVE A STRONG UNDERSTANDING OF RADIOMETRIC FUNDAMENTALS AS WELL AS THE PRODUCTS AND CONDITIONS OF COMBUSTION THAT IMPACT REMOTE TEMPERATURE MEASUREMENT.** The Infrared Training Center (ITC) offers a wide range of world class infrared training for thermography professionals including FLIR GF309 operators. For more information about obtaining the training and certification you require, contact your FLIR Systems sales representative or ITC at <http://www.infraredtraining.com>.

 **CAUTION**

Applicability: Cameras with a viewfinder.

Make sure that the beams from the intensive energy sources do not go into the viewfinder. The beams can cause damage to the camera. This includes the devices that emit laser radiation, or the sun.

3.1 User-to-user forums

Exchange ideas, problems, and infrared solutions with fellow thermographers around the world in our user-to-user forums. To go to the forums, visit:

<http://forum.infraredtraining.com/>

3.2 Calibration

Gas detection: no re-calibration recommendation. The ability to detect gases is not influenced by the calibration and will not degrade over time.

Temperature measurement: annual re-calibration recommended.

3.3 Accuracy

For very accurate results, we recommend that you wait 5 minutes after you have started the camera before measuring a temperature.

For cameras where the detector is cooled by a mechanical cooler, this time period excludes the time it takes to cool down the detector.

3.4 Disposal of electronic waste

Electrical and electronic equipment (EEE) contains materials, components and substances that may be hazardous and present a risk to human health and the environment when waste electrical and electronic equipment (WEEE) is not handled correctly.

Equipment marked with the below crossed-out wheeled bin is electrical and electronic equipment. The crossed-out wheeled bin symbol indicates that waste electrical and electronic equipment should not be discarded together with unseparated household waste, but must be collected separately.

For this purpose all local authorities have established collection schemes under which residents can dispose waste electrical and electronic equipment at a recycling centre or other collection points, or WEEE will be collected directly from households. More detailed information is available from the technical administration of the relevant local authority.



3.5 Training

To read about infrared training, visit:

- <http://www.infraredtraining.com>
- <http://www.irtraining.com>
- <http://www.irtraining.eu>

3.6 Documentation updates

Our manuals are updated several times per year, and we also issue product-critical notifications of changes on a regular basis.

To access the latest manuals, translations of manuals, and notifications, go to the Download tab at:

<http://support.flir.com>

It only takes a few minutes to register online. In the download area you will also find the latest releases of manuals for our other products, as well as manuals for our historical and obsolete products.

3.7 Note about authoritative versions

The authoritative version of this publication is English. In the event of divergences due to translation errors, the English text has precedence.

Any late changes are first implemented in English.

FLIR Thermography and Instruments Customer Support Center

Get support for thermography, fire fighting and instruments products

Welcome to the FLIR Instruments Customer Support Center. This portal will help you to get the most out of your FLIR Instruments products. The portal gives you access to:

- Instruments Knowledgebase
- Ask our support team (requires registration)
- Software and documentation (requires registration)
- Instruments service contacts

Find Answers

Search in our FAQ to find answers.

Search by Keyword

[Search All Answers](#)

[See All Popular Answers](#)

Register Your Products

[Register](#)

You will gain access to special discounts and offers, downloads, and software upgrades.

[Register for free today](#)

FLIR Benefits Program

FLIR has decided to offer existing customers holding a valid license for certain software a free upgrade.

[Enter Now](#)

Infrared Training Center

Your premier educational and training resource for infrared camera use.

[Get training](#)

[E-learning \(English\)](#)

[Get training in Europe, Middle East and Africa](#)

[E-learning \(multiple languages\)](#)

Click this link to find a manual for a current product.

To find a datasheet for a current product, click on a picture.
To find a datasheet for a legacy product, click here.

FLIR T5xx	FLIR A310f	FLIR A310pt	FLIR A3xx	FLIR A6xx	FLIR Aerial
FLIR AX	FLIR AxS	FLIR Cx	FLIR ETS3xx	FLIR Ex	More...
Product catalogs	Software	Accessories	Training		

[Important legal disclaimer, dangers, warnings, and cautions](#)

4.1 General

For customer help, visit:

<http://support.flir.com>

4.2 Submitting a question

To submit a question to the customer help team, you must be a registered user. It only takes a few minutes to register online. If you only want to search the knowledgebase for existing questions and answers, you do not need to be a registered user.

When you want to submit a question, make sure that you have the following information to hand:

- The camera model
- The camera serial number
- The communication protocol, or method, between the camera and your device (for example, SD card reader, HDMI, Ethernet, USB, or FireWire)
- Device type (PC/Mac/iPhone/iPad/Android device, etc.)
- Version of any programs from FLIR Systems
- Full name, publication number, and revision number of the manual

4.3 Downloads

On the customer help site you can also download the following, when applicable for the product:

- Firmware updates for your infrared camera.
- Program updates for your PC/Mac software.
- Freeware and evaluation versions of PC/Mac software.
- User documentation for current, obsolete, and historical products.
- Mechanical drawings (in *.dxf and *.pdf format).
- Cad data models (in *.stp format).
- Application stories.
- Technical datasheets.
- Product catalogs.

Important note about training and applications

5.1 General

Infrared inspection of gas leaks, furnaces, and high-temperature applications—including infrared image and other data acquisition, analysis, diagnosis, prognosis, and reporting—is a highly advanced skill. It requires professional knowledge of thermography and its applications, and is, in some countries, subject to certification and legislation.

Consequently, we strongly recommend that you seek the necessary training before carrying out inspections. Please visit the following site for more information:

<http://www.infraredtraining.com>

List of accessories and services

Product name	Part number
Battery charger, incl. power supply with multi plugs	T197692
Calibration including General maintenance GF3xx series	T199834
Cigarette lighter adapter kit, 12 VDC, 1.2 m/3.9 ft.	T198509
FLIR IR Camera Player	DSW-10000
FLIR Reporter Professional (license only)	T198586
FLIR ResearchIR 3 (license only)	T198578
FLIR ResearchIR 3 Max (license only)	T198574
FLIR ResearchIR Max + HSDR 4	T198697
FLIR ResearchIR Max 4	T198696
FLIR ResearchIR Standard 4	T198731
FLIR Tools	T198584
FLIR Tools Mobile (Android Application)	APP-10002
FLIR Tools Mobile (iPad/iPhone Application)	APP-10003
FLIR Tools+ (license only)	T198583
FLIR VideoReport	T198585
Furnace IR lens extender, 14.5° with case for GF309	T198361
Furnace IR lens extender, 24° with case for GF309	T198360
Hard transport case for FLIR GF3xx-Series	T197555
HDMI to DVI cable 1.5 m	T910816ACC
HDMI to HDMI cable 1.5 m	T910815ACC
Heat Shield for FLIR GF309	T197482
IR lens, 14.5° with case for GF300, GF309, GF320	T197385
IR lens, 14.5° with case for GF304, GF306	T197384
IR lens, 14.5° with case for GF335, GF346	T198298
IR lens, 24° with case for GF300, GF309, GF320	T197387
IR lens, 24° with case for GF304, GF306	T197386
IR lens, 24° with case for GF335, GF346	T198267
IR lens, 6° with case for GF300, GF309, GF320, GF346.	T197388
ITC Advanced Furnace Application Course - additional student to on site class	ITC-ADV-3055
ITC Advanced Furnace Application Course - attendance, 1 pers. (3 days)	ITC-ADV-3051
ITC Advanced Furnace Applications Course - group up to 10 pers. (3 days)	ITC-ADV-3059
ITC Advanced Furnace Applications Course - group up to 6 persons (3 days)	ITC-ADV-3056
ITC Advanced Gas Detection Course - additional student to on site class, 1 pers.	ITC-ADV-3035
ITC Advanced Gas Detection Course - attendance, 1 pers.	ITC-ADV-3031

List of accessories and services

Product name	Part number
ITC Advanced Gas Detection Course - group of up to 6 pers. (3 days)	ITC-ADV-3036
ITC Advanced Gas Detection Course – group of 10 pers.	ITC-ADV-3039
ITC Advanced training - group of max. 6 pers, additional day 4 for on-site training	ITC-ADV-4006
ITC conference fee	ITC-CON-1001
ITC Customized workshop - per person (per day)	ITC-EXP-1041
ITC In-house training - additional attendance 1 pers. (per day)	ITC-EXP-1021
ITC In-house training - group up to 10 pers. (per day)	ITC-EXP-1029
ITC Infrared application and system consultancy (per day)	ITC-EXP-1050
ITC Software course - attendance 1 pers. (per day)	ITC-SOW-0001
ITC Software course - group up to 10 pers. (per day)	ITC-SOW-0009
ITC Training 1 day - attendance 1 pers.	ITC-EXP-1001
ITC Training 1 day - group up to 10 pers.	ITC-EXP-1009
ITC Training 2 days - attendance 1 pers.	ITC-EXP-2001
ITC Training 2 days - group up to 10 pers.	ITC-EXP-2009
ITC Training 3 days - attendance 1 pers.	ITC-EXP-3001
ITC Training 3 days - group up to 10 pers.	ITC-EXP-3009
ITC travel time for instructor	ITC-TFT-0100
Li-Ion Battery pack 7.4V 33Wh	T198511
Memory card SDHC 4 GB	T911230ACC
One year extended warranty for GF3xx series	T199825
Power supply, incl. multi plugs	T910814
ThermoVision™ LabVIEW® Digital Toolkit Ver. 3.3	T198566
ThermoVision™ System Developers Kit Ver. 2.6	T198567
Travel and lodging expenses instructor (Center and South Africa)	ITC-TOL-1003
Travel and lodging expenses instructor (Europe, Balkans, Turkey, Cyprus)	ITC-TOL-1001
Travel and lodging expenses instructor (other)	ITC-TOL-1005
Travel and lodging expenses instructor (Russia/ GUS, Middle East, North Africa)	ITC-TOL-1002
Travel and lodging expenses instructor (various)	ITC-TOL-1004
USB cable Std A <-> Mini-B	1910423
Wi-Fi USB micro adapter	T951387

Note FLIR Systems reserves the right to discontinue models, parts or accessories, and other items, or to change specifications at any time without prior notice.

7.1 FLIR GF300

7.1.1 Optical gas imaging of methane and other volatile organic compounds (VOCs)

The FLIR GF300 is an IR camera for optical gas imaging (OGI) that visualizes and pinpoints leaks of VOCs, without the need to shut down the operation. The portable camera also greatly improves operator safety, by detecting emissions at a safe distance, and helps to protect the environment by tracing leaks of environmentally harmful gases.

The FLIR GF300 is used in industrial settings such as oil refineries, natural gas processing plants, offshore platforms, chemical/petrochemical industries, and biogas and power generation plants.

7.1.2 Benefits

- **Improved efficiency:** The FLIR GF300 reduces revenue loss by pinpointing even small gas leaks quickly and efficiently, and from a distance. It also reduces the inspection time by allowing a broad area to be scanned rapidly and without the need to interrupt the industrial process.
- **Increased worker safety:** OGI allows gas leaks to be detected in a non-contact mode and from a safe distance. This reduces the risk of the inspector being exposed to invisible and potentially harmful or explosive chemicals. With a FLIR GF300 gas imaging camera it is easy to scan areas of interest that are difficult to reach with conventional methods. The camera is ergonomically designed, with a bright LCD and tiltable viewfinder, which facilitates its use over a full working day.
- **Protecting the environment:** Several VOCs are dangerous to human health or cause harm to the environment, and are usually governed by regulations. Even small leaks can be detected and documented using the FLIR GF300 camera.

7.2 FLIR GF304

7.2.1 Optical gas imaging of refrigerant gases

The FLIR GF304 is an IR camera for optical gas imaging (OGI) that visualizes and pinpoints leaks of refrigerant gases, without the need to shut down the operation. This portable camera also greatly improves operator safety, by detecting gases at a safe distance, and helps to protect the environment by tracing leaks of environmentally harmful gases.

Refrigerant gases are found in, for example, the food, chemical/petrochemical and automotive industries, as well as in air-conditioning systems.

7.2.2 Benefits

- **Improved efficiency:** The FLIR GF304 reduces revenue loss by pinpointing even small gas leaks quickly and efficiently, and from a distance. It also reduces the inspection time by being able to scan a broad area rapidly without the need to interrupt the industrial process. The wireless connectivity of the camera allows you to connect to smart phones or tablet PCs for the wireless transfer of images or the remote control of the camera. The FLIR GF304 can also be used for temperature measurement, which makes it even more useful for predictive maintenance.
- **Increased worker safety:** The leak detection of gases can be performed in noncontact mode, and from a safe distance. This reduces the risk of the inspector being exposed to invisible and potentially harmful or explosive chemicals. With a FLIR GF304 gas-imaging camera it is easy to scan areas of interest that are difficult to reach with

conventional methods. The camera is ergonomically designed with a bright LCD and a tiltable viewfinder, which facilitates its use over a full working day.

- Protecting the environment: Several refrigerant gases have a high global warming potential and are usually governed by regulations. Even small leaks can be detected and documented using the FLIR GF304 camera.

7.3 FLIR GF306

7.3.1 Optical gas imaging especially of SF6 and ammonia

The FLIR GF306 is an IR camera for optical gas imaging (OGI) that visualizes and pinpoints gas leaks of SF6 and ammonia, without the need to de-energize high-voltage equipment or shut down the operation. The portable camera also greatly improves operator safety, by detecting emissions at a safe distance, and helps to protect the environment by tracing leaks of environmentally harmful gases.

SF6 is used in the electric power industry as an insulator and quenching medium for gas-insulated substations and circuit breakers. The gas is also used in magnesium production and semiconductor manufacture. Ammonia is produced in ammonia plants, and is used mainly for the production of fertilizers.

7.3.2 Benefits

- Improved efficiency: The FLIR GF306 reduces revenue loss by pinpointing even small gas leaks quickly and efficiently, and from a distance. It also reduces the inspection time by allowing a broad area to be scanned rapidly and without the need to de-energize components in the high-voltage area. The wireless connectivity of the camera allows you to connect to smart phones or tablet PCs for the wireless transfer of images or remote control of the camera. The FLIR GF306 can also be used for temperature measurement, which makes it even more useful for predictive maintenance of high-voltage equipment.
- Increased worker safety: OGI allows gas leaks to be detected in a non-contact mode and from a safe distance. This prevents electrical exposure to personnel working in a high-voltage area. With a FLIR GF306 gas imaging camera it is easy to scan areas of interest that are difficult to reach with conventional methods. The camera is ergonomically designed, with a bright LCD and tiltable viewfinder, which facilitates its use over a full working day.
- Protecting the environment: SF6 is a well-known greenhouse gas that can cause harm to the environment, and is usually governed by regulations. SF6 has a global warming potential 24,000 times higher than CO2. Even small leaks can be detected and documented using the FLIR GF306 camera.

7.4 FLIR GF309

7.4.1 IR camera for furnace and high temperature inspection

The FLIR GF309 is an IR camera for the high-temperature measurement of industrial furnaces, chemical heaters, and coal-fired boilers, without the need to shut down the operation. The portable camera also greatly improves operator safety, by measuring through flames at a safe distance, for all types of furnaces. A good knowledge of the furnace condition can avert failures and unscheduled shutdowns

Industrial furnaces, heaters, and boilers are found in the chemical, petrochemical, and utility industries.

7.4.2 Benefits

- **Improved efficiency:** The FLIR GF309 reduces inspection time by measuring the temperature through flames without the need to interrupt the industrial process or await scheduled service shutdowns. A furnace camera can help you to determine how to run a furnace/boiler efficiently to give the best fuel economy and maximize production output and quality. As the FLIR GF309 has a wide temperature range, high-accuracy electrical and mechanical inspections can be performed, which makes the camera even more useful for predictive maintenance.
- **The wireless connectivity of the camera** allows you to connect to smart phones or tablet PCs for the wireless transfer of images or the remote control of the camera—a useful function if regulations require a second person to accompany the furnace inspector or thermal images needs to be sent quickly for a second opinion.
- **Increased worker safety:** High-temperature measurement can be performed through flames in a non-contact mode, and from a safe distance. Custom-built, the FLIR GF309 also features a detachable heat-shield designed to reflect heat away from the camera and the camera operator, providing increased protection. The camera is ergonomically designed with a bright LCD and tiltable viewfinder, which facilitates its use over a full working day.
- **Increased furnace safety:** Good knowledge of furnace/boiler condition and operating parameters can provide the information needed to avert catastrophic failures and prevent unscheduled shutdowns.

7.5 FLIR GF320

7.5.1 Optical gas imaging of methane and other volatile organic compounds (VOCs)

The FLIR GF320 is an IR camera for optical gas imaging (OGI) that visualizes and pinpoints leaks of VOCs, without the need to shut down the operation. The portable camera also greatly improves operator safety, by detecting emissions at a safe distance, and helps to protect the environment by tracing leaks of environmentally harmful gases.

The FLIR GF320 is used in industrial settings such as oil refineries, natural gas processing plants, offshore platforms, chemical/petrochemical industries, and biogas and power generation plants.

7.5.2 Benefits

- **Improved efficiency:** The FLIR GF320 reduces revenue loss by pinpointing even small gas leaks quickly and efficiently, and from a distance. It also reduces the inspection time by allowing a broad area to be scanned rapidly and without the need to interrupt the industrial process. The wireless connectivity of the camera allows you to connect to smart phones or tablet PCs for the wireless transfer of images or remote control of the camera. The FLIR GF320 is also used for temperature measurement, which makes it even more useful for predictive maintenance.
- **Increased worker safety:** OGI allows gas leaks to be detected in a non-contact mode and from a safe distance. This reduces the risk of the inspector being exposed to invisible and potentially harmful or explosive chemicals. With a FLIR GF320 gas imaging camera it is easy to scan areas of interest that are difficult to reach with conventional methods. The camera is ergonomically designed, with a bright LCD and tiltable viewfinder, which facilitates its use over a full working day.
- **Protecting the environment:** Several VOCs are dangerous to human health or cause harm to the environment, and are usually governed by regulations. Even small leaks can be detected and documented using the FLIR GF320 camera.

7.6 FLIR GF335

The FLIR GF335 is a high-sensitivity, low-noise, cooled infrared camera for applications requiring a portable camera able to detect very subtle temperature differences. The high performance of the camera makes it perfect for the detection of faint heat signatures as well as for non-destructive testing and quality control applications.

7.6.1 Benefits

- **High performance:** The FLIR GF335 features a cooled 3–5 μm InSb detector that produces razor-sharp thermal images. Its high sensitivity of <15 mK and high accuracy of $\pm 1^\circ\text{C}$ ($\pm 1.8^\circ\text{F}$) or 1% allow the user to detect very subtle temperature differences with astounding clarity.
- **Improved efficiency:** The wireless connectivity of the FLIR GF335 allows connection to smart phones and tablets for the wireless transfer of images or the remote control of the camera—a useful function if a second person is required to accompany the inspector. The camera also features built-in radiometric video recording, and can store MPEG-4 thermal and/or standard video on an SD card. The camera has an integrated GPS and a digital camera, and is compatible with Flir Tools, Flir Reporter, and Flir Researcher software.
- **Thought-through ergonomics for everyday use:** The FLIR GF335 is ergonomically designed, with a bright LCD and tiltable viewfinder, which facilitates its use over a full working day. A multi-angle handle with integrated direct access buttons also improves the ergonomics.

7.7 FLIR GF343

7.7.1 The new FLIR GF343 is an optical gas camera for visualizing carbon dioxide (CO₂)

With this camera you can quickly and easily find gas leaks where CO₂ is the main component.

Key features:

- Visualizes gas leaks in real time.
- Inspects without interruption of process.
- Traces leaks to its source.

7.7.2 Main applications

Carbon capture and storage—stop the escalation of global warming:

- A global transition to sustainable low-carbon economy.
- A global energy demand still dominated by fossil fuels being combusted in quantities incompatible with levels required to stabilize greenhouse gases concentrations at safe levels in the atmosphere.

CO₂ (R744)—the new environmental friendly refrigerant:

- Air-conditioning for cars—replaces R134a.
- CO₂ based heat pumps.
- Electrical power—replaces SF₆.

CO₂—a harmless tracer gas:

- H₂S applications often use a large amount of CO₂.
- Use CO₂ to trace leaks.

7.8 FLIR GF346

7.8.1 Optical gas imaging especially of carbon monoxide (CO) and other harmful gases

The FLIR GF346 is an IR camera for optical gas imaging (OGI) that visualizes and pin-points gas leaks of CO, without the need to shut down the operation. The portable camera also greatly improves operator safety, by detecting emissions at a safe distance, and helps to protect the environment by tracing leaks of environmentally harmful gases.

CO is an industrial gas with applications in the steel industry and bulk chemicals manufacturing. It is also used for packaging systems for fresh meat and fish.

7.8.2 Benefits

- **Improved efficiency:** The FLIR GF346 reduces revenue loss by pinpointing even small gas leaks quickly and efficiently, and from a distance. It also reduces the inspection time by allowing a broad area to be scanned rapidly and without the need to interrupt the industrial process. The wireless connectivity of the camera allows you to connect to smart phones or tablet PCs for the wireless transfer of images or remote control of the camera. The FLIR GF346 can also be used for temperature measurement, which makes it even more useful for predictive maintenance.
- **Increased worker safety:** CO can be toxic to humans when encountered in higher concentrations. OGI allows gas leaks to be detected in a non-contact mode and from a safe distance. This reduces the risk of the inspector being exposed to invisible and highly toxic gases or explosive chemicals. With a FLIR GF346 gas imaging camera it is easy to scan areas of interest that are difficult to reach with conventional methods. The camera is ergonomically designed, with a bright LCD and tiltable viewfinder, which facilitates its use over a full working day.
- **Protecting the environment:** Several gases, like CO, have a high global warming potential, and are usually governed by regulations. Even small leaks can be detected and documented using the FLIR GF346 camera.

8.1 General

This section contains example images from various applications.

Note Gas leaks are easier to see in live image mode, which is the reason the leaks are indicated with a red dot in the images below.

8.2 Images

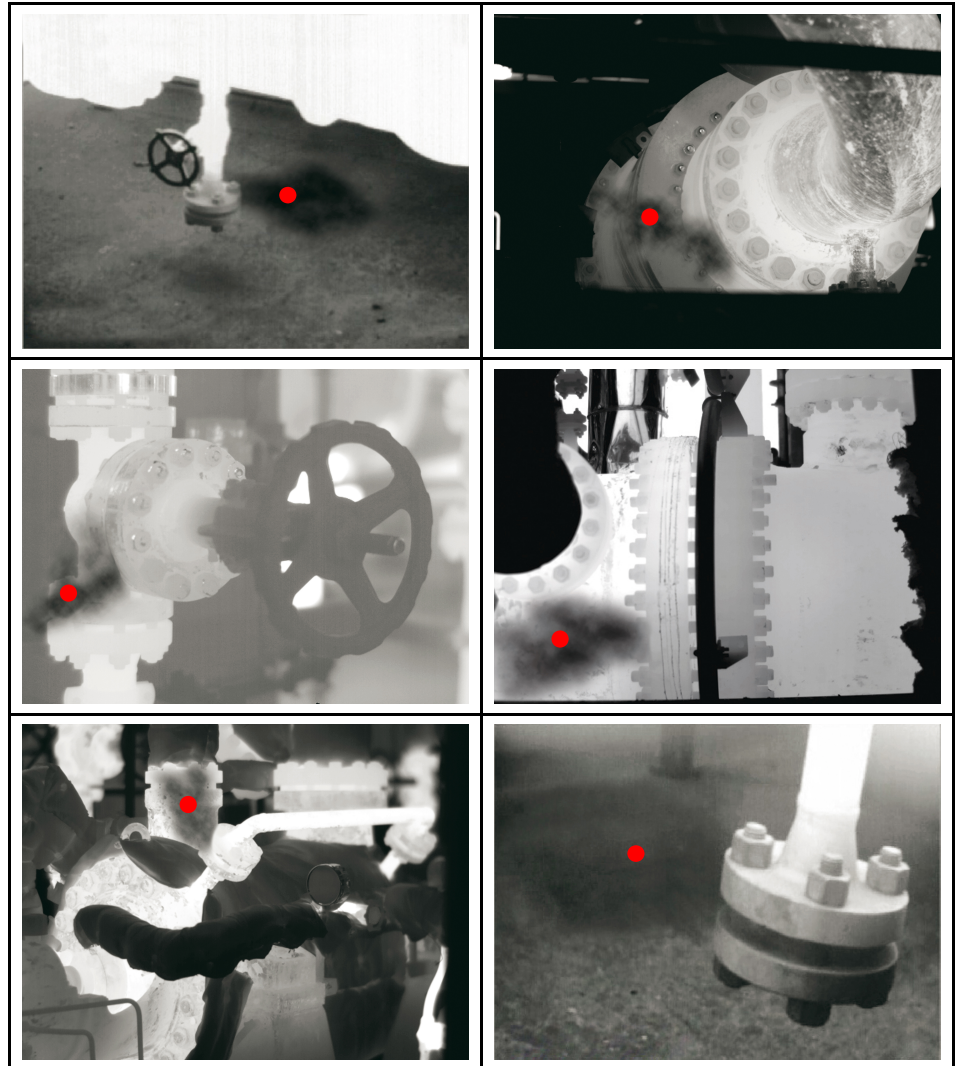

9.1 Detecting a temperature

 **CAUTION**

In furnace and other high-temperature applications, you must mount the heatshield on the camera. Using the camera in furnace and other high-temperature applications without the heatshield can cause damage to the camera.

For instructions on how to mount the heatshield, see 16.12 *Mounting the heatshield*, page 54.

9.1.1 Procedure



Follow this procedure to get started right away:

1. Charge the battery for four hours, or until the green battery condition LED glows continuously, before starting the camera for the first time.

Note Do this at room temperature, with the camera turned off.

2. Insert an SD Memory Card into a card slot
3. To turn on the camera, push the  button.

Note When you turn on the camera, a mechanical cooler will begin cooling down the infrared detector. The cooler has a sound that resembles a subdued motor. This sound is normal. The cooling procedure will typically take 7 minutes for FLIR GF300, FLIR GF309, FLIR GF320, and 10 minutes for FLIR GF306. In high ambient temperatures the cooling times may increase 30% or more.

4. Turn the mode wheel to .
5. For furnace and other high-temperature applications, mount the heatshield on the camera. You must also enter the correct external optics transmission value of the heatshield into the camera. The external optics transmission value is printed on a label on the inside of the heatshield. You enter the external optics transmission value in the object parameters dialog on the *Edit* tab.
When you remove the heatshield you must reset the external optics transmission to 1.0.
6. Push the temperature range button, then do the following:
 - 6.1. Move the joystick up/down to choose a suitable temperature range for your object.
 - 6.2. Push the temperature range button to confirm and leave the setup mode.
7. Aim the camera towards the object of interest.
8. Autofocus the camera by pushing the center of the **FOCUS | ZOOM** button.
9. Push the  button.
10. Move the joystick left/right to the *Edit* tab.
11. Move the joystick up/down to *Add spot*.
12. Push the joystick. A spotmeter is now displayed in the middle of the screen. The temperature is displayed in the result table in the top left corner of the screen.
13. To save an image directly, push and hold the **S** button for more than one second.

14. To move the image to a computer, do one of the following:

- Remove the SD Memory Card and insert it in a card reader connected to a computer.
- Connect a computer to the camera using a USB mini-B cable.

15. Move the image from the card or camera, respectively, using a drag-and-drop operation.

9.1.2 Related topics

- 16.1.1 *Charging the battery using the power supply cable*, page 46
- 16.1.2 *Charging the battery using the stand-alone battery charger*, page 46
- 16.2.1 *Installing the battery*, page 47
- 15.4 *Inserting SD Memory Cards*, page 44
- 16.3 *Turning on the camera*, page 49
- 18.1 *Laying out a measurement tool*, page 64
- 17.1 *Saving infrared images*, page 60

9.2 Detecting a gas leak

9.2.1 Procedure

Follow this procedure to get started right away:

1. Charge the battery for four hours, or until the green battery condition LED glows continuously, before starting the camera for the first time.

Note Do this at room temperature, with the camera turned off.

2. Insert an SD Memory Card into a card slot.

3. To turn on the camera, push the  button.

Note When you turn on the camera, a mechanical cooler will begin cooling down the infrared detector. The cooler has a sound that resembles a subdued motor. This sound is normal. The cooling procedure will typically take 7 minutes for FLIR GF300, FLIR GF309, FLIR GF320, and 10 minutes for FLIR GF306. In high ambient temperatures the cooling times may increase 30% or more.

4. Turn the mode wheel to .

5. Push the temperature range button, then do the following:

- 5.1. Move the joystick up/down to choose a suitable temperature range for your object.
- 5.2. Push the temperature range button to confirm and leave the setup mode.

6. Aim the camera towards the target of interest.

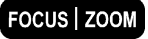
7. Autofocus the camera by pushing the center of the  button.

8. If there is a gas leak, and the gas is one of the gases that the camera can detect, you will now see the leak on the screen. The leak will resemble smoke plume emanating from the point of the leak.

9. To start recording a video clip, push the  button.

10. To stop recording a video clip, push the  button again.
11. To move the video clip to a computer, do one of the following:
 - Remove the SD Memory Card and insert it in a card reader connected to a computer.
 - Connect a computer to the camera using a USB mini-B cable.
12. Move the video clip from the card or camera, respectively, using a drag-and-drop operation.

9.2.2 Related topics

- 16.1.1 *Charging the battery using the power supply cable*, page 46
- 16.1.2 *Charging the battery using the stand-alone battery charger*, page 46
- 16.2.1 *Installing the battery*, page 47
- 15.4 *Inserting SD Memory Cards*, page 44
- 16.3 *Turning on the camera*, page 49
- 18.1 *Laying out a measurement tool*, page 64
- 17.1 *Saving infrared images*, page 60
- 20 *Recording video clips*, page 69

FLIR GF3xx series series general instrument check

The following general instrument check process ensures that the camera can detect the intended gas compounds with the same sensitivity as when originally manufactured.

1. Make sure that the camera powers on.
2. Make sure that the camera completes the cool-down process and produces a live infrared image.
3. Make sure that the camera does not report any error messages on startup.
4. Make sure that the camera focuses properly.
5. Make sure that the camera is able to engage HSM mode.

11.1 General

To prevent overstrain injuries, it is important that you hold the camera ergonomically correct. This section gives advice and examples on how to hold the camera.

Note Please note the following:

- Always tilt the viewfinder to fit your work position.
- Always adjust the viewing angle of the display to fit your work position.
- Always adjust the camera grip to fit your work position.
- When you hold the camera, make sure that you support the camera housing with your left hand too. This decreases the strain on your right hand.

11.2 Figure

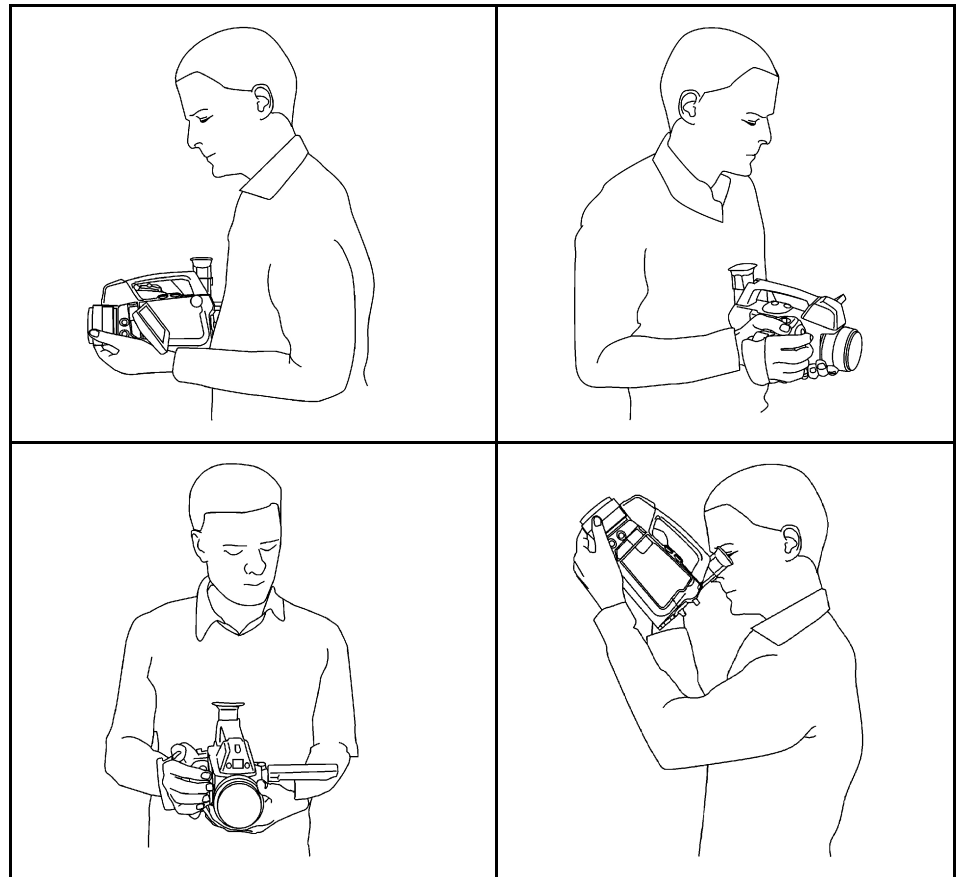

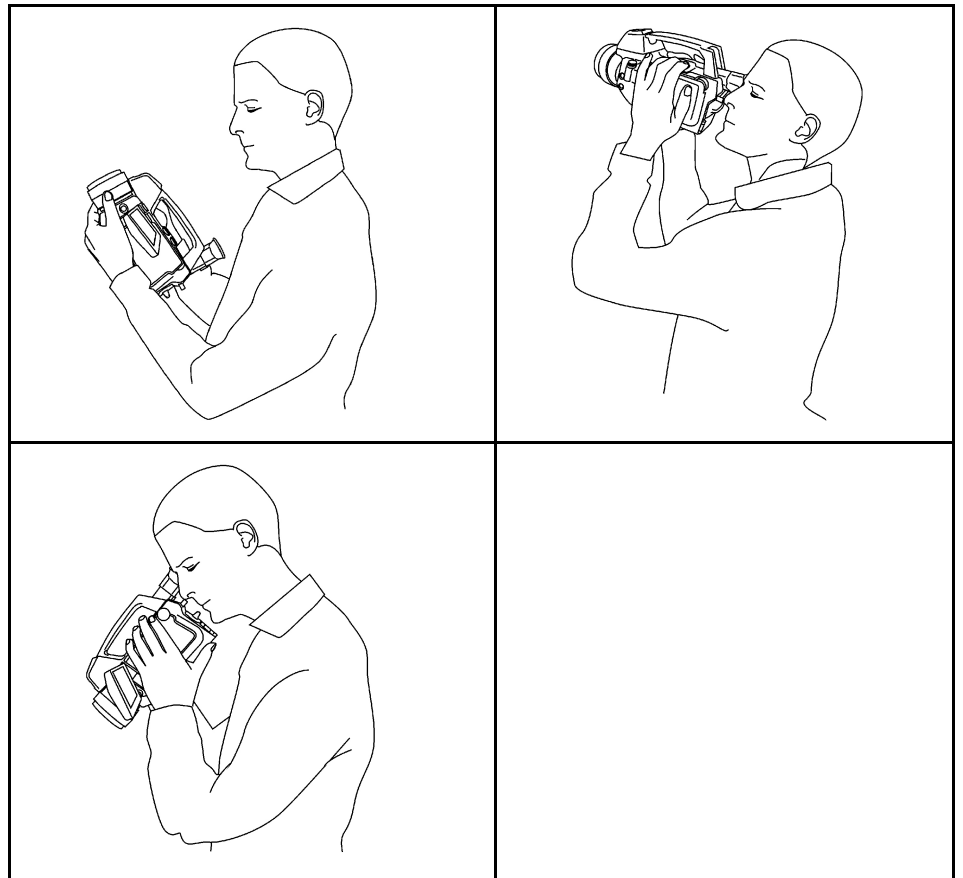

11.3 Related topics

- 16.5 *Adjusting the viewing angle of the viewfinder*, page 49
- 16.7 *Adjusting the camera grip*, page 50
- 16.9 *Adjusting the viewing angle of the display*, page 52

12.1 View from the left

12.1.1 Figure

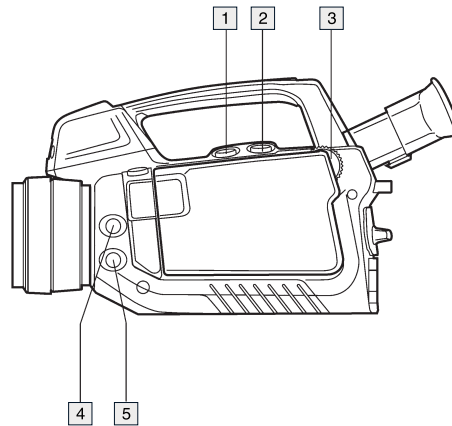

12.1.2 Explanation

1. Programmable button for one of the following functions:

- Change the zoom factor.
- Hide/show graphics.
- Change the polarity.
- Change the palette.

You program the button in setup mode  in the *Preferences* tab.

2. Temperature range button.

3. Mode wheel  with the following modes:

- Camera mode: Save images.
- Video mode: Record video clips and video sequences.
- Archive mode: View saved images, video clips, and video sequences.
- Program mode: Set up periodical saving of images.
- Setup mode: Change the general settings.

4. Laser button.

5. Button to go between infrared mode and digital camera mode.

12.2 View from the right

12.2.1 Figure

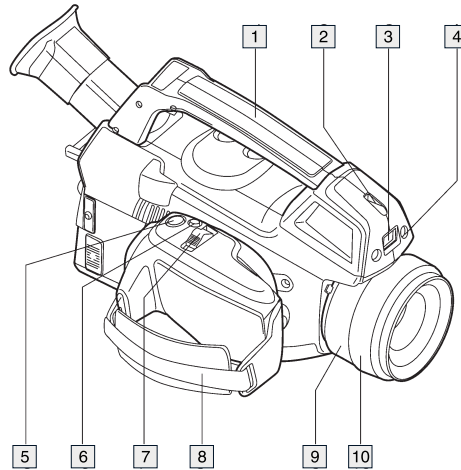

12.2.2 Explanation

1. Camera handle.
2. Laser pointer.
3. Digital video camera.
4. Digital camera lamps. When you are in digital camera mode, you turn on the lamps by pushing the joystick.

5. **S** button (Preview/Save).

*The **S** button has the following functions (not applicable to video clips and video sequences):*

- To preview an image before saving it, push and release the button.
- To save an image directly, push and hold the button for more than 1 second.

6. A/M button (Auto/Manual).

The A/M button has the following functions:

- Push and release the button to change the image adjustment method between *Auto*, *Manual*, and *HSM*.

Note HSM mode does not apply to the FLIR GF309.

- Push and hold down the button for more than 1 second to calibrate the camera.

Note This is typically not needed during normal operating procedures.

7. **FOCUS | ZOOM** button.

The **FOCUS | ZOOM** button has the following functions:

When an image is in live mode:

- To adjust the focus, push the button left/right.
- To autofocus, push the center of the **FOCUS | ZOOM** button.

When an image is in preview or saved mode:

- To adjust the zoom, push the **FOCUS | ZOOM** button left/right.

8. Hand strap.
9. Focus ring on the infrared lens.
10. Infrared lens.

12.3 View from the rear

12.3.1 Figure

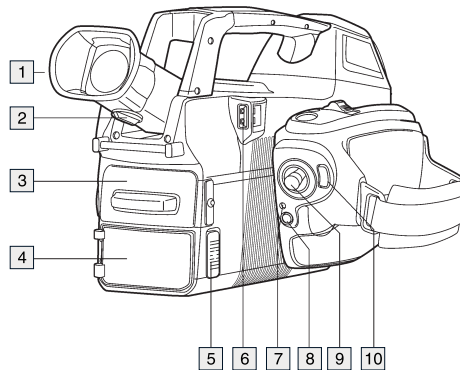

12.3.2 Explanation

1. Viewfinder.
2. Adjustment knob for the viewfinder's diopter correction.
3. Cover for the connector compartment.
4. Cover for the battery compartment.
5. Release button for the battery compartment cover.
6. USB-A connector for external USB devices.
7. Power LED indicator.

8.  button (On/off).

The  button has the following functions:

- When the camera is off, push and release to turn on the camera.
- When the camera is on, push and hold for more than 0.2 second to turn off the camera.

9. Joystick.

The joystick has the following functions:

- To navigate in menus and dialog boxes, move the joystick up/down/left/right.
- To change values, move the joystick up/down/left/right.
- To select or confirm choices, push the joystick.

10.  button (Menu/Back).

12.4 Battery condition LED indicator

12.4.1 Figure

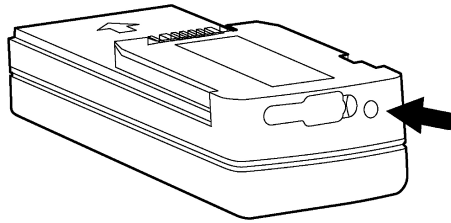

12.4.2 Explanation

This table gives an explanation of the battery condition LED indicator:

Type of signal	Explanation
The LED is red and glows continuously.	The battery needs to be charged..
The LED is green and flashes.	The battery is being charged.
The LED is green and glows continuously.	The battery is fully charged.
The LED is off.	The power supply or the stand-alone battery charger is disconnected from the battery.

12.5 Power LED indicator

12.5.1 Figure

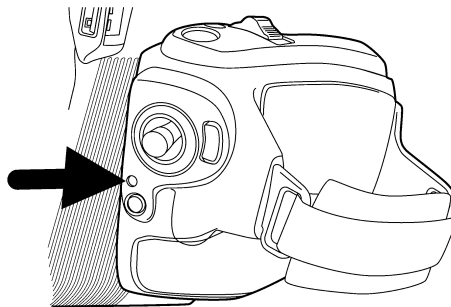

12.5.2 Explanation

This table gives an explanation of the power LED indicator:

Type of signal	Explanation
The LED is off.	The camera is off.
The LED is green.	The camera is on.

12.6 Laser pointer

12.6.1 General

The camera has a laser pointer. When the laser pointer is on, you will see a laser dot approximately 80 mm (3.15") above the target.

12.6.2 Figure

This figure shows the difference in position between the laser pointer and the optical center of the infrared lens:

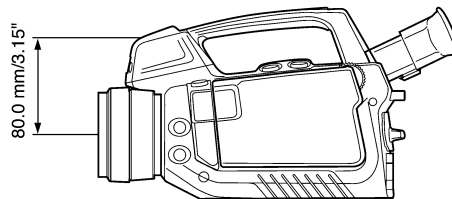

WARNING

Do not look directly into the laser beam. The laser beam can cause eye irritation.

Note The symbol  is displayed on the screen when the laser pointer is on.

12.6.3 Laser warning label

A laser warning label with the following information is attached to the camera:

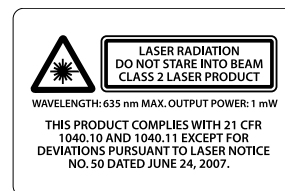

12.6.4 Laser rules and regulations

Wavelength: 635 nm. Maximum output power: 1 mW.

This product complies with 21 CFR 1040.10 and 1040.11 except for deviations pursuant to Laser Notice No. 50, dated June 24, 2007.

13.1 Mode selector

Note To select the mode, turn the mode wheel  on the left side of the camera.

13.1.1 Figure

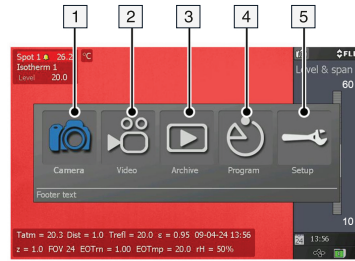

13.1.2 Explanation

1. Camera mode.
2. Video mode: Record video clips (*.mp4) and video sequences (*.seq).
3. Archive mode: View saved images and video sequences.
4. Program mode: Set up periodical saving of images.
5. Setup mode: Change the general settings.

13.2 Result table and measurement tools

Note To access the measurement tools, push the  button.

13.2.1 Figure

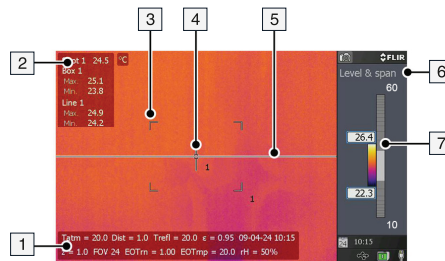

13.2.2 Explanation

1. Status bar.
2. Result table.
3. Area (measurement tool).
4. Spotmeter (measurement tool).
5. Line (measurement tool).
6. Adjustment method indicator.

7. Temperature scale.

13.3 Toolbox, indicators, and other objects

13.3.1 Figure

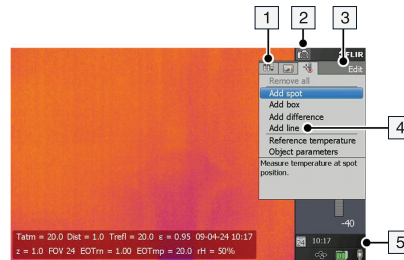

13.3.2 Explanation

1. Menu tab.
2. Mode indicator.
3. Menu tab name.
4. Menu item.
5. Status indicators:
 - Time.
 - Date.
 - GPS indicator.
 - USB indicator.
 - Power indicator (battery or mains supply).
 - SD memory card indicator ("I" or "II"). The indicator also shows the amount of free space on the SD memory card. As a warning, the indicator will turn yellow and then red as the amount of free space decreases.

14.1 General

A good image depends on several different settings, although some settings affect the image more than other.

These are the settings you need to experiment with:

- Adjusting the infrared camera focus.
- Adjusting the image, using *Auto*, *Manual*, or *HSM* (= *High Sensitivity Mode*).
- Selecting a suitable temperature range.
- Selecting a suitable color palette.
- Enabling or disabling histogram mode.
- Enabling or disabling inverted color palette.
- Changing object parameters.

This section explains how to change these settings.

14.2 Adjusting the infrared camera focus manually

Note Do not touch the lens surface when you adjust the infrared camera focus manually. If this happens, clean the lens according to the instructions in *25.2 Infrared lens*, page 229.

14.2.1 Figure

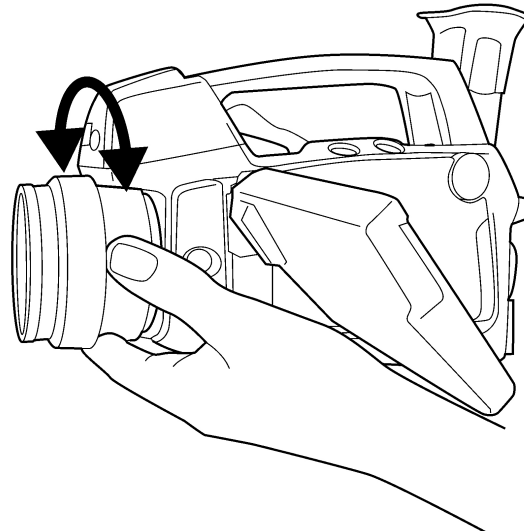

14.2.2 Procedure

Do one of the following:

- For far focus, rotate the focus ring counter-clockwise (looking at the front of the lens)
- For near focus, rotate the focus ring clock-wise (looking at the front of the lens)

14.3 Adjusting the infrared camera focus

14.3.1 Figure

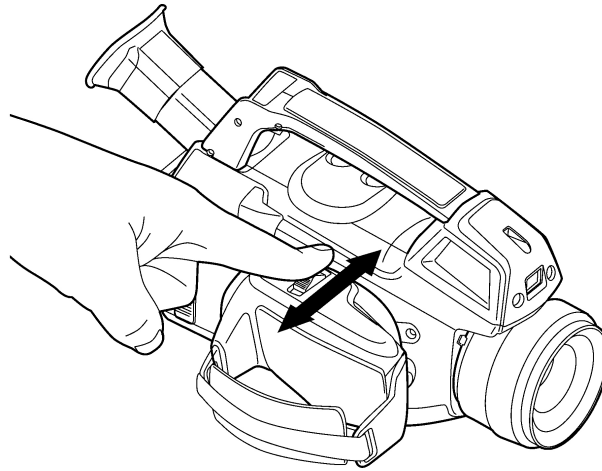

14.3.2 Procedure

Follow this procedure to adjust the infrared camera focus:

1. Make sure that the image is in live mode.
2. To adjust the camera focus, push the **FOCUS | ZOOM** button left/right.

14.4 Adjusting an image

14.4.1 General



Depending on camera model, an image can be adjusted in several different ways.

14.4.2 Explanation of the adjustment methods

<i>Auto</i>	An adjustment method that will automatically adjust the image for best brightness and contrast.
<i>HSM</i>	HSM = High Sensitivity Mode. An adjustment method that is specifically designed for gas detection applications. Working in this mode, you can change the sensitivity to optimize the image quality.
<i>Manual</i>	An adjustment method where you manually set the suitable temperature level and temperature span according to the temperature of the objects in the scene. For gas detection applications, this mode lets you center on the temperatures around the background of the gas, so as to make the gas appear more clearly.

14.4.3 Procedure (*Auto*)

Follow this procedure to adjust an image using the *Auto* method:

1. Turn the mode wheel to  or .

-
2. Push the *A/M* button to select *Auto*. The image will now be continuously adjusted for best image brightness and contrast.



14.4.4 Figure

This figure shows the *HSM* slider:





14.4.5 Procedure (*HSM*)

Follow this procedure to adjust an image using the *HSM* method:

1. Turn the mode wheel to  or .
2. Push the *A/M* button to select *HSM*. To change the sensitivity, move the joystick left/right.
You will need to experiment with this setting until you get a clear image of a verified gas leak.

14.4.6 Procedure (*Manual*)

Follow this procedure to adjust an image using the *Manual* method:

1. Turn the mode wheel to  or .
2. Push the *A/M* button to select *Manual*, then do one of the following:
 - To change the temperature level, move the joystick up/down.
 - To change the temperature span, move the joystick left/right.

14.5 Selecting a suitable temperature range

14.5.1 About temperature ranges

14.5.1.1 General

The camera has three different types of ranges. Within each type of range, there are several subranges. You must choose a suitable range for your object.

14.5.1.2 Types of temperature ranges

Type	Name	Example	Explanation
1	Characteristic temperature range	-40°C to +350°C (-40°F to +662°F)	All temperatures the camera can register. This range is the total sum of the temperature ranges (type no. 2 below).
2	Temperature range	+10°C to +50°C (+50°F to +122°F)	The span of temperatures that the camera can register with the current settings. This type of range is a subrange to type no. 1 above.
3	Temperature span	+23.8°C to +25.9°C (+74.8°F to +78.6°F)	The range of temperatures that the camera registers when aimed at a particular scene with a particular temperature range set.

14.5.2 Understanding the temperature scale

14.5.2.1 Figure

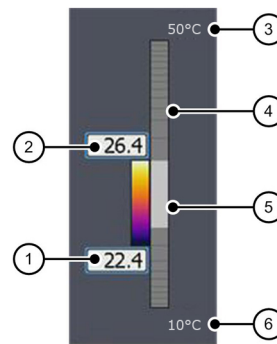

14.5.2.2 Explanation

1. Currently set minimum temperature in the temperature span (= range of type 3 in the table 14.5.1.2 *Types of temperature ranges*, page 39).
2. Currently set maximum temperature in the temperature span (= range of type 3 in the table 14.5.1.2 *Types of temperature ranges*, page 39).
3. Currently set maximum temperature in the range that the camera can register with the current settings (= range of type 2 in the table 14.5.1.2 *Types of temperature ranges*, page 39).
4. Indicator that represents the temperature range (= range of type 2 in the table 14.5.1.2 *Types of temperature ranges*, page 39).
5. Indicator that represents the temperature span (= range of type 3 in the table 14.5.1.2 *Types of temperature ranges*, page 39).

-
- Currently set minimum temperature in the range that the camera can register with the current settings (= range of type 2 in the table 14.5.1.2 *Types of temperature ranges*, page 39).

14.5.3 Changing the temperature range





14.5.3.1 Procedure

Follow this procedure to change the temperature range:

- Do one of the following:
 - Push the temperature range button on the left side of the camera.
 - Push the  button, then select *Adjust temp. range*.
- Move the joystick up/down to choose a suitable temperature range for your object.
- Push the temperature range button to confirm and leave the setup mode.

14.6 Selecting a suitable color palette

14.6.1 Procedure





- Turn the mode wheel to  or .
- Push the  button to display a menu.
- Move the joystick left/right to go to the *Image* tab.
- Move the joystick up/down to go to select *Color palette*.
- Push the joystick to enable the list of palettes.
- Move the joystick up/down to select a new palette.
- Push the joystick.
- Push the  button to leave the setup mode.

14.7 Enabling or disabling histogram mode

14.7.1 General





Histogram mode is an image-displaying method that evenly distributes the color information over the existing temperatures of the image.

14.7.2 Procedure

- Turn the mode wheel to  or .
- Push the  button to display a menu.
- Move the joystick left/right to go to the *Image* tab.
- Move the joystick up/down to go to select *Histogram*.
- Push the joystick to enable/disable the setting.
- Push the  button to leave the setup mode.

14.8 Enabling or disabling inverted color palette

14.8.1 Procedure

1. Turn the mode wheel to  or .
2. Push the  button to display a menu.
3. Move the joystick left/right to go to the *Image* tab.
4. Move the joystick up/down to go to select *Invert palette*.
5. Push the joystick to enable/disable the setting.
6. Push the  button to leave the setup mode.

14.9 Changing object parameters

14.9.1 General

For accurate measurements, you must set the object parameters. You can do this locally or globally. This procedure describes how to change the object parameters globally.

14.9.2 Types of parameters

The camera can use these object parameters:

- *Emissivity*, i.e., how much radiation an object emits, compared to the radiation of a theoretical reference object of the same temperature (called a “blackbody”). The opposite of emissivity is reflectivity. The emissivity determines how much of the radiation originates from the object as opposed to being reflected by it.
- *Reflected apparent temperature*, which is used when compensating for the radiation from the surroundings reflected by the object into the camera. This property of the object is called reflectivity.
- *Object distance*, i.e., the distance between the camera and the object of interest.
- *Atmospheric temperature*, i.e., the temperature of the air between the camera and the object of interest.
- *Relative humidity*, i.e., the relative humidity of the air between the camera and the object of interest.
- *External optics temperature*, i.e., the temperature of any protective windows etc. that are set up between the camera and the object of interest. If no protective window or protective shield is used, this value is irrelevant.
- *External optics transmission*, i.e., the optical transmission of any protective windows, etc. that are set up between the camera and the object of interest.

Note For furnace and other high-temperature applications, mount the heatshield on the camera. You must also enter the correct external optics transmission value of the heatshield into the camera. The external optics transmission value is printed on a label on the inside of the heatshield. You enter the external optics transmission value in the object parameters dialog on the *Edit* tab.

When you remove the heatshield you must reset the external optics transmission to 1.0.

14.9.3 Recommended values





If you are unsure about the values, the following values are recommended:

Emissivity	0.95
Distance	1.0 m (3.3 ft.)

Reflected apparent temperature	+20°C (+69°F)
Relative humidity	50%
Atmospheric temperature	+20°C (+69°F)

14.9.4 Procedure

Follow this procedure to change the object parameters globally:

1. Turn the mode wheel to  or .
2. Push the  button to display a menu.
3. Move the joystick left/right to go to the *Edit* tab.
4. Move the joystick up/down to select *Object parameters*.
5. Push the joystick to display a dialog box.
6. Move the joystick up/down to select the parameter you want to change, then push the joystick.
7. Move the joystick up/down to change the value, then push the joystick.
8. Push the  button to confirm and leave the setup mode.

Note

- Of the seven parameters above, *emissivity* and *reflected apparent temperature* are the two most important to set correctly in the camera.
- To change object parameters *locally*, first select a measurement tool in the toolbox, then select *Use local parameters*. Change the local parameters by selecting *Edit local parameters*, then edit them in the same way as for global object parameters.

14.9.5 Related topics

- For in-depth information about parameters, and how to correctly set emissivity and reflected apparent temperature, see 32 *Thermographic measurement techniques*.

15.1 General

You can connect the following external devices to the camera:

- A power supply.
- A video monitor or projector, connected using a HDMI cable.
- A computer to move images and other files to and from the camera.
- An external USB device, such as a USB keyboard, USB memory stick, USB-Bluetooth micro adapter (to connect to a headset), or a USB-WLAN micro adapter (to connect the camera to a remote control (P/N T197230)).
- One or two SD Memory Cards.
- One or two SDHC Memory cards.

15.2 Related topics

- 15.3 *Connecting devices to the rear connectors*, page 43
- 15.4 *Inserting SD Memory Cards*, page 44

15.3 Connecting devices to the rear connectors

15.3.1 Figure

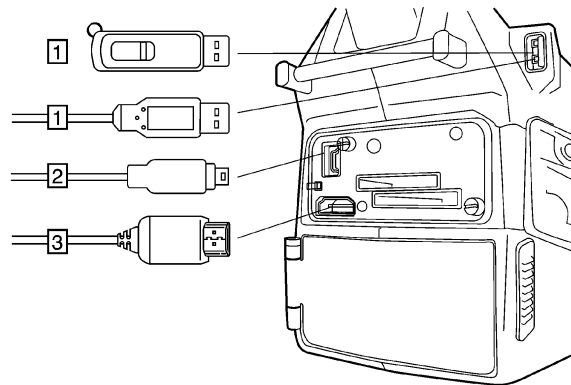

15.3.2 Explanation

1. To connect an external USB device to the camera, use a USB-A cable and this connector. You can also plug in a USB memory stick in this connector, or a USB-Bluetooth micro adapter. For WLAN connectivity to a remote control (P/N T197230), use a USB-WLAN micro adapter.
2. To connect a computer to the camera to move images and files to and from the camera, use a USB mini-B cable and this connector. This connector is also used when pairing the camera to the remote control (P/N T197230).
3. To play live video from the camera on an external video monitor using the HDMI protocol (High Definition Multimedia Interface), use a HDMI cable and this connector.

15.3.3 Figure

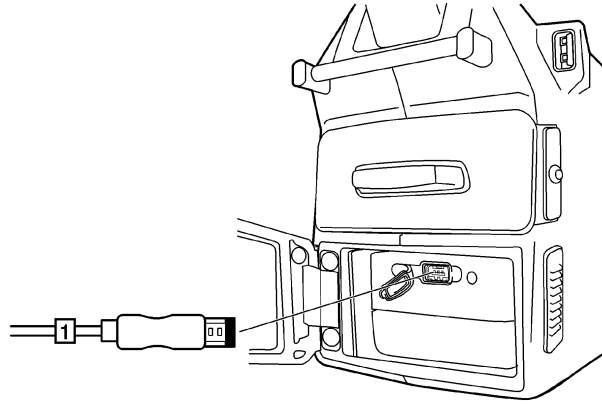

15.3.4 Explanation

To connect the power supply to the camera, use the power supply cable and this connector. The power connector is protected by a rubber cover.

15.4 Inserting SD Memory Cards

15.4.1 Figure

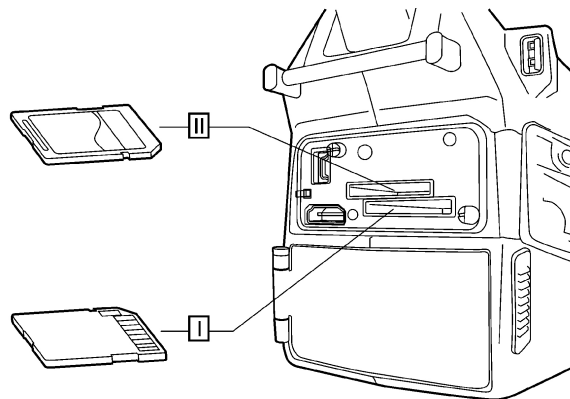

15.4.2 Explanation

- I. To insert an SD Memory Card (identified with Roman numeral 'I' in the camera program), use this card slot.

Note The connectors on the card shall face *up* when inserting the card.

- II. To insert an SD Memory Card (identified with Roman numeral 'II' in the camera program), use this card slot.

Note The connectors on the card shall face *down* when inserting the card.

15.4.3 Formatting memory cards

For best performance, memory cards should be formatted to the FAT (FAT16) file system. Using FAT32-formatted memory cards may result in inferior performance. To format a memory card to FAT (FAT16), follow this procedure:

1. Insert the memory card into a card reader that is connected to a computer running Microsoft Windows.
2. In Windows Explorer, select *My Computer* and right-click the memory card.
3. Select *Format*.
4. Under *File system*, select *FAT*.
5. Click *Start*.

Note

- SDHC memory cards that are 4 GB or larger can only be formatted to the FAT32 file system.

16.1 Charging the camera battery

16.1.1 Charging the battery using the power supply cable

Note

- You must charge the battery for four hours before starting the camera the first time. After that, you must charge the battery whenever a warning message for low battery power is displayed on the screen.
- The battery has a battery condition LED indicator. When the green LED glows continuously, the battery is fully charged.
- Charge the battery at room temperature. If you charge the battery when it is inside the camera, the camera should be turned off. Charging the battery when it is inside the camera will not result in a fully charged battery.

16.1.1.1 Procedure

Follow this procedure to charge the battery using the power supply cable:

1. Connect the power supply cable plug to the connector on the battery.
2. Connect the power supply wall plug to a mains supply.
3. When the green LED of the battery condition indicator glows continuously, disconnect the power supply cable.

16.1.1.2 Related topics

- For information about the battery condition LED indicator, see 12.4 *Battery condition LED indicator*, page 32.
- For information on how to install and remove the battery, see 16.2.1 *Installing the battery*, page 47 and 16.2.2 *Removing the battery*, page 48.

16.1.2 Charging the battery using the stand-alone battery charger

Note

- You must charge the battery for 4 hours before starting the camera for the first time. After that, you must charge the battery whenever a warning message for low battery power is displayed on the screen.
- The battery has a battery condition LED indicator. When the green LED glows continuously, the battery is fully charged.
- Charge the battery at room temperature.

16.1.2.1 Procedure

Follow this procedure to charge the battery using the stand-alone battery charger:

1. Put the battery in the stand-alone battery charger.
2. Connect the power supply cable plug to the connector on the stand-alone battery charger.
3. Connect the power supply wall plug to a mains supply.
4. When the green LED of the battery condition indicator glows continuously, disconnect the power supply cable.

16.1.2.2 Related topics

- For information about the battery condition LED indicator, see 12.4 *Battery condition LED indicator*, page 32.
- For information on how to install and remove the battery, see 16.2.1 *Installing the battery*, page 47 and 16.2.2 *Removing the battery*, page 48.

16.2 Installing and removing the camera battery

16.2.1 Installing the battery

Note Use a clean, dry cloth to remove any water or moisture on the battery before you install it.

16.2.1.1 Procedure

Follow this procedure to install the battery:

1. Push the release button for the battery compartment upwards.

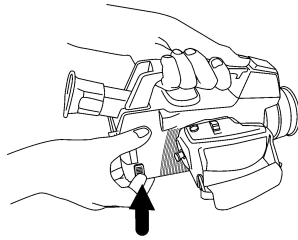

2. Open the battery compartment cover.

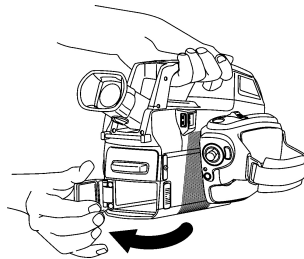

3. Push the battery into the battery compartment.

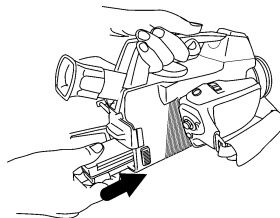

4. Close the battery compartment cover.

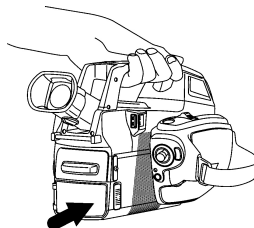

16.2.2 Removing the battery

16.2.2.1 Procedure

Follow this procedure to remove the battery:

1. Push the release button for the battery compartment upwards.

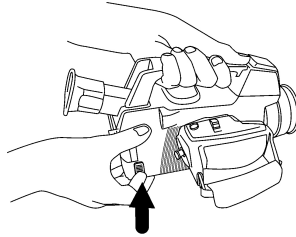

2. Open the battery compartment cover.

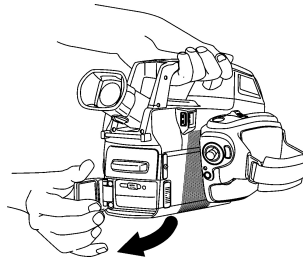

3. Push the release lever for the battery downward.

Note In this image, the thumb obscures the actual release lever. The mechanism to the right of the thumb is the locking mechanism for the battery compartment.

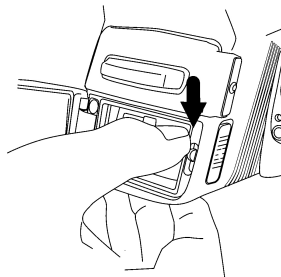

4. Pull out the battery from the battery compartment.

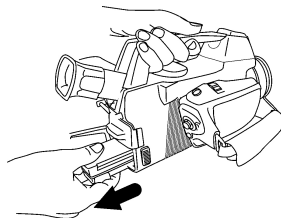

16.3 Turning on the camera

16.3.1 Procedure

To turn on the camera, push and release the  button.

Note When you turn on the camera, a mechanical cooler will begin cooling down the infrared detector. The cooler has a sound that resembles a subdued motor. This sound is normal. The cooling procedure will typically take 7 minutes for FLIR GF300, FLIR GF309, FLIR GF320, and 10 minutes for FLIR GF306. In high ambient temperatures the cooling times may increase 30% or more.

16.4 Turning off the camera

16.4.1 Procedure

To turn off the camera, push and hold the  button for more than 0.2 seconds.

16.5 Adjusting the viewing angle of the viewfinder

16.5.1 General

To make your working position as comfortable as possible, you can adjust the viewing angle of the viewfinder.

16.5.2 Figure

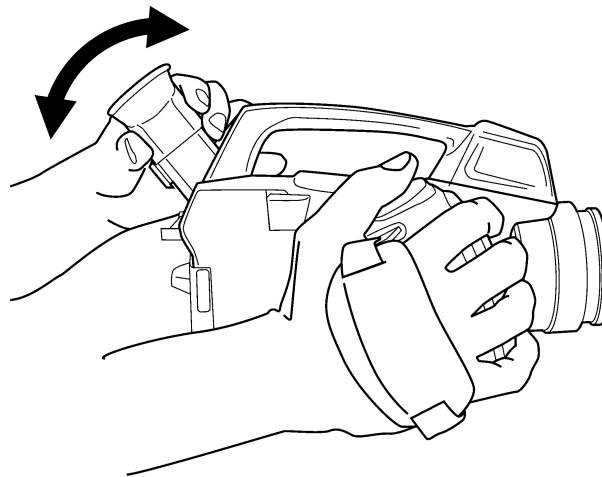

16.5.3 Procedure

To adjust the viewfinder, tilt the viewfinder up or down.

16.6 Adjusting the viewfinder's dioptic correction

16.6.1 General

The viewfinder's dioptic correction can be adjusted for your eyesight.

16.6.2 Figure

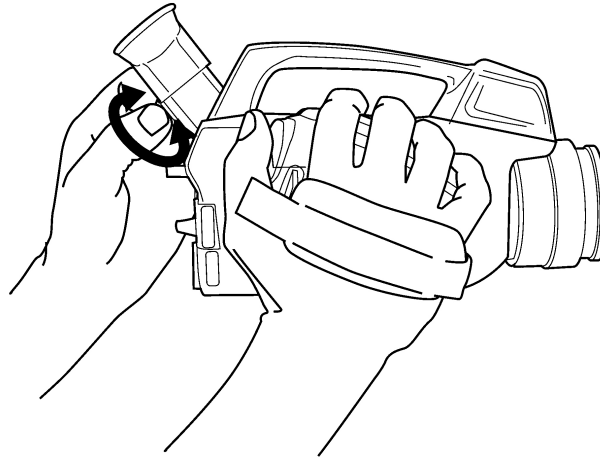

16.6.3 Procedure

To adjust the viewfinder's dioptic correction, look at the displayed text or graphics on the screen and rotate the adjustment knob clockwise or counter-clockwise for best sharpness.

Note

- Maximum dioptic correction: +2
- Minimum dioptic correction: -2

16.7 Adjusting the camera grip

16.7.1 General

To make your working position as comfortable as possible, you can adjust the angle of the camera grip.

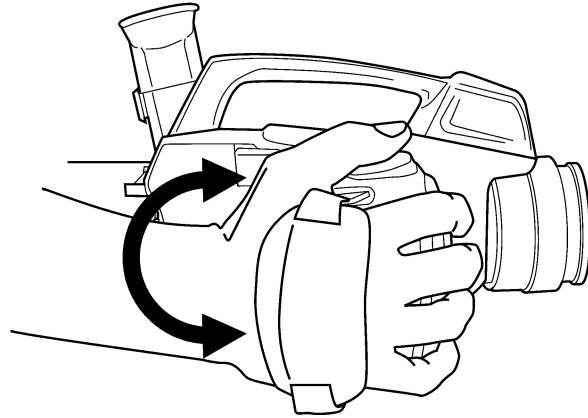
16.7.2 Figure**16.7.3 Procedure**

To adjust the camera grip, rotate the camera grip clockwise or counter-clockwise.

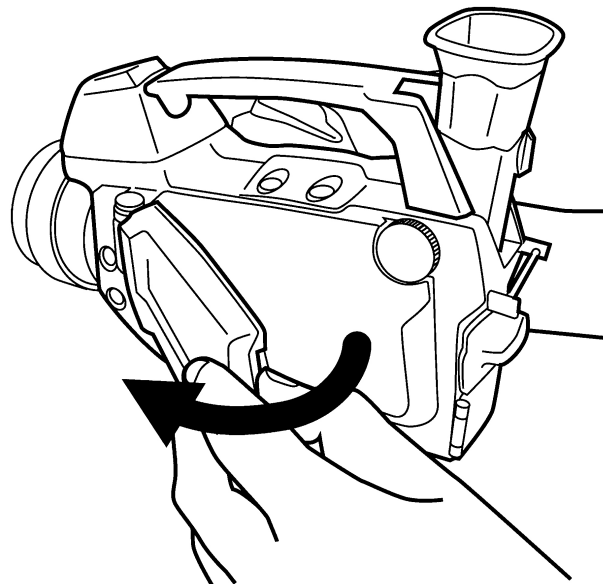
16.8 Opening the display**16.8.1 Figure**

16.9 Adjusting the viewing angle of the display

16.9.1 General

To make your working position as comfortable as possible, you can adjust the viewing angle of the display.

16.9.2 Figure

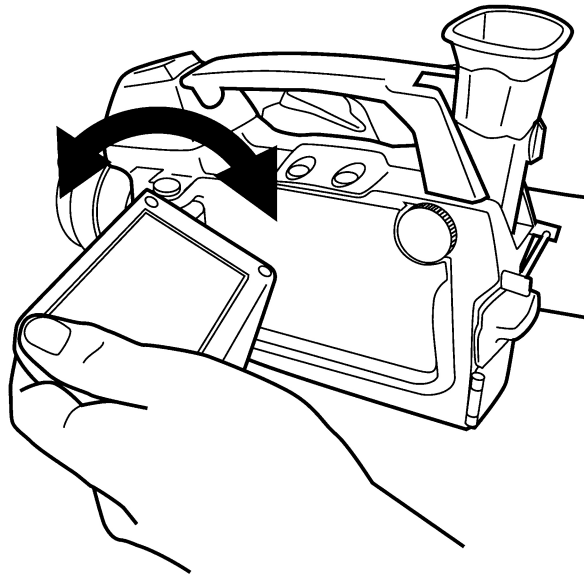

16.9.3 Procedure

To adjust the viewing angle of the display, rotate the display clockwise or counter-clockwise.

16.10 Installing an infrared lens

Note

- Do not touch the lens surface when you install an infrared lens. If this happens, clean the lens according to the instructions in 25.2 *Infrared lens*, page 229.
- Depending on license and export procedures, lenses may be permanently fixed to cameras shipped to customers outside United States. Interchangeable lenses fall under U. S. Department of State jurisdiction.

16.10.1 Procedure

Follow this procedure to install an infrared lens:

1. Align the index mark on the lens with the index mark on the bayonet ring.

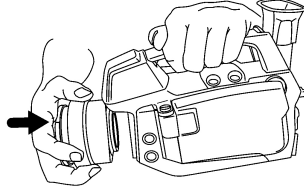

2. Carefully push the infrared lens into the bayonet ring.

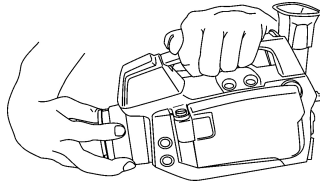

3. Rotate the infrared lens 30° clockwise (looking at the front of the lens).

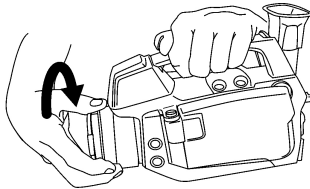

16.11 Removing an infrared lens

Note

- Do not touch the lens surface when you remove an infrared lens. If this happens, clean the lens according to the instructions in 25.2 *Infrared lens*, page 229.
- When you have removed the lens, put the lens caps on the lens to protect it from dust and fingerprints.
- Depending on license and export procedures, lenses may be permanently fixed to cameras shipped to customers outside United States. Interchangeable lenses fall under U. S. Department of State jurisdiction.

16.11.1 Procedure

Follow this procedure to remove an infrared lens:

1. Push the release button for the infrared lens forward.

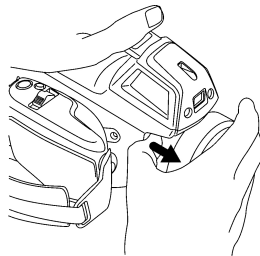

2. Rotate the infrared lens counter-clockwise 30° (looking at the front of the lens).

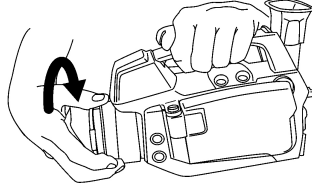

3. Carefully pull out the infrared lens from the bayonet ring.

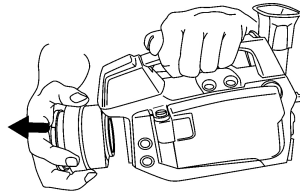

16.12 Mounting the heatshield

16.12.1 General

In furnace and other high-temperature applications, you must mount the heatshield on the camera.

You must also enter the correct external optics transmission value of the heatshield into the camera. The external optics transmission value is printed on a label on the inside of the heatshield. You enter the external optics transmission value in the object parameters dialog on the *Edit* tab.

CAUTION

Using the camera in furnace and other high-temperature applications without the heatshield can cause damage to the camera.

16.12.2 Procedure

Follow this procedure to mount a heatshield:

1. Remove the two nuts from the heatshield.

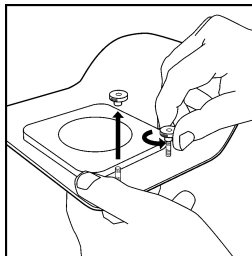

-
2. Push the aluminum frame onto the screws.

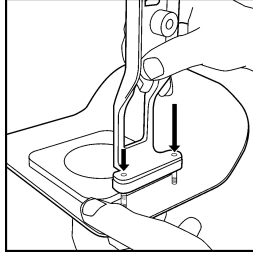

3. Mount and tighten the two nuts.

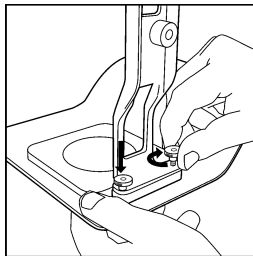

4. Align the aluminum frame to the mounting interface on the bottom side of the camera body. The aluminum frame has an alignment peg that should fit in a hole on the camera body.

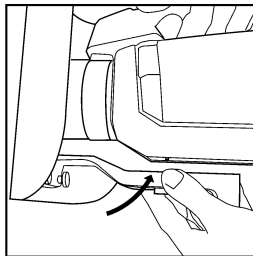

5. Mount the aluminum frame by tightening the mounting screw.

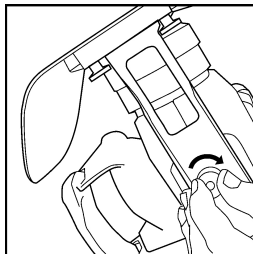

Note When you remove the heatshield you must reset the external optics transmission to 1.0.

16.13 Adjusting the infrared camera focus manually

Note Do not touch the lens surface when you adjust the infrared camera focus manually. If this happens, clean the lens according to the instructions in 25.2 *Infrared lens*, page 229.

16.13.1 Figure

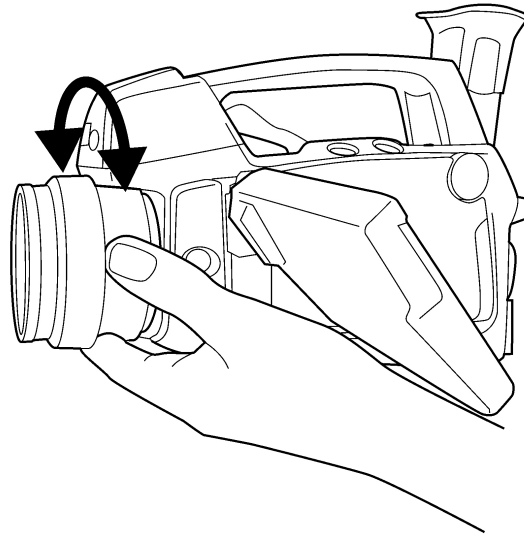

16.13.2 Procedure

Do one of the following:

- For far focus, rotate the focus ring counter-clockwise (looking at the front of the lens)
- For near focus, rotate the focus ring clock-wise (looking at the front of the lens)

16.14 Adjusting the infrared camera focus

16.14.1 Figure

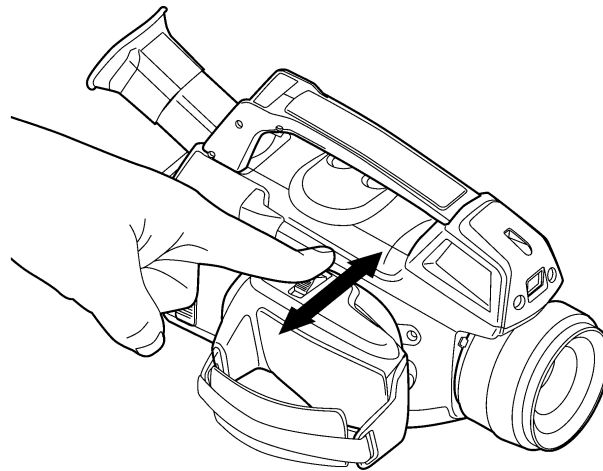

16.14.2 Procedure

Follow this procedure to adjust the infrared camera focus:

1. Make sure that the image is in live mode.
2. To adjust the camera focus, push the **FOCUS | ZOOM** button left/right.

16.15 Autofocusing the infrared camera and the digital camera

16.15.1 Figure



16.15.2 Procedure

Follow this procedure to autofocus the infrared camera and the digital camera:

1. Make sure that the image is in live mode.
2. To autofocus, push the center of the **FOCUS | ZOOM** button.

16.16 Operating the laser pointer

16.16.1 Figure

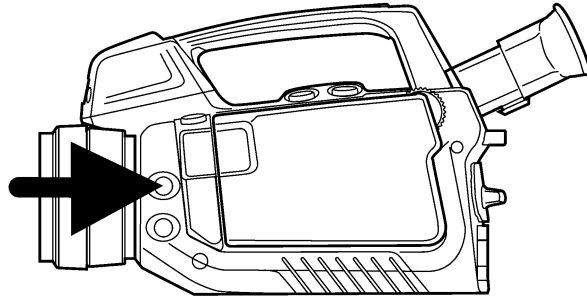

16.16.2 Procedure

Follow this procedure to operate the laser pointer:

1. To turn on the laser pointer, push and hold the laser button.
2. To turn off the laser pointer, release the laser button.



WARNING

Do not look directly into the laser beam. The laser beam can cause eye irritation.

Note The symbol  is displayed on the screen when the laser pointer is on.

16.16.3 Laser warning label

A laser warning label with the following information is attached to the camera:

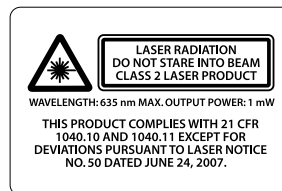

16.17 Using the zoom function

16.17.1 General

You can zoom in on infrared images in preview or recall mode. This enables you to view details in an image.

16.17.2 Procedure

Do one of the following:

- To zoom into a live image, choose *Zoom* on the second tab in the menu system, then use the joystick.
- To zoom into a image in recall mode, push the **FOCUS | ZOOM** button left/right.

17.1 Saving infrared images

17.1.1 General

You can save one or more images to an SD Memory Card.

17.1.2 Image capacity

The *approximate* number of images that can be saved on an SD Memory Card is 2,000 per GB.



17.1.3 Saving an infrared image directly to an SD Memory Card

17.1.3.1 General

You can save an image directly to an SD Memory Card, without previewing the image first.

17.1.3.2 Procedure

Follow this procedure to save an image directly to an SD Memory Card:

1. Turn the mode wheel to .
2. To save an image without previewing, push and hold the  button for more than one second.

17.1.4 Previewing and saving an infrared image to an SD Memory Card

17.1.4.1 General

You can preview an image before you save it to an SD Memory Card. This lets you do one or more of the following tasks before you save the image:





- Edit measurements.
- Adjust the image.
- Add a digital photo.
- Delete an image.

17.1.4.2 Procedure

Follow this procedure to preview and save an image to an SD Memory Card:

1. Turn the mode wheel to .
2. Push and release the  button. This will display a preview dialog box.

3. You can now do one or more of the following tasks before you save the image. Move the joystick to go to a task and push the joystick to select the task.

- Select  to edit measurement tools.
- Select  to adjust the image.
- Select  to add a digital photo to the image. You turn on the digital camera lamps by pushing the joystick. Push the **S** button to take a digital photo.
- Select  to delete the image.
- Select  to save the image.



17.2 Opening an image

17.2.1 General

When you save an image, you store the image on an SD Memory Card. To display the image again, you can open it from the SD Memory Card.

17.2.2 Procedure

Follow this procedure to open an image:

1. Turn the mode wheel to  to enter archive mode. This displays the archive overview or an image at full size.
2. In the archive overview, you can do the following:
 - Move the joystick up/down/left/right to select the image you want to view.
 - Push the joystick. This displays the selected image at full size.
3. When an image is displayed at full size, you can do the following:
 - Push the joystick or the  button to edit the measurements, adjust the image, or delete the image. This displays a menu.
 - Move the joystick left/right to view the previous/next image.
 - Move the joystick up to return to the archive overview.
4. To leave the archive mode, turn the mode wheel and select another mode.

17.3 Changing settings related to image presentation

17.3.1 General

In live mode, you can enable/disable a variety of settings relating to image presentation. These settings include:





- Zoom, i.e., zoom into or out of images.
- Hide/show graphics, i.e. hide or show the on-screen graphics.
- Change the color palette, i.e. the colors that are used to display the temperatures in the infrared image.

- Invert polarity, i.e. change the image polarity from *white = hot* to *black = hot*.
- Histogram equalization, i.e., an image-displaying method that evenly distributes the color information over the existing temperatures of the image.

Note In preview and archive mode, you can do the following related to image presentation:

- Push the  button left/right to zoom into or out of the image.
- Depending on the function you have assigned to the programmable button, you can hide/show graphics, change the polarity, or change the palette. For more information, see section , page .

17.3.2 Procedure

1. Turn the mode wheel to  or .
2. Push the  button to display a menu.
3. Move the joystick left/right to go to the *Image* tab.
4. Move the joystick up/down to go to select the setting that you want to change.
5. Push the joystick to enable/disable the setting.
(If you select *Zoom* you can change the zoom factor by moving the joystick up/down.)
6. Push the  button to leave the setup mode.

17.4 Editing a saved image

17.4.1 General



You can edit a saved image. You can do one or more of the following tasks:

- Edit measurements.
- Adjust the image.
- Delete the image.



17.4.2 Procedure

Follow this procedure:

1. Open the image at full size in the archive. For more information, see section 17.2 *Opening an image*, page 61.
2. Push the joystick or the . This displays a menu.
3. You can now do one or more of the following tasks. Move the joystick to go to a task and push the joystick to select the task.

- Select  to edit measurement tools.
- Select  to adjust the image.



Note You can only adjust an image that has been saved in *Auto* or *Manual* mode. An image saved in *HSM* mode cannot be adjusted. For more information, see section 14.4 *Adjusting an image*, page 37.

- Select  to delete the image.
- Select  to save any changes and exit edit mode.

17.5 Deleting a file

17.5.1 Procedure

Follow this procedure to delete an image file, a video clip, or a video sequence:

1. Turn the mode wheel to  to enter archive mode. This displays the archive overview or an image at full size.
2. If an image is displayed at full size, move the joystick up to go to the archive overview.
3. Move the joystick up/down/left/right to select the image you want to delete.
4. Push the  button to display a menu.
5. Move the joystick up/down to select one of the following:
 - *Delete*
 - *Delete all*
6. Push the joystick.
7. Confirm the deletion and push the joystick.



18.1 Laying out a measurement tool

18.1.1 General

To measure a temperature, you use one or several measurement tools, such as a spot-meter, a box, etc.

18.1.2 Procedure

Follow this procedure to lay out measurement tool:

1. Turn the mode wheel to  or .
2. Push the  button to display a menu.
3. Move the joystick left/right to go to the *Edit* tab.
4. Move the joystick up/down to select the measurement tool you want to lay out.
5. Push the joystick. The measurement tool has now been created on the screen.

18.2 Moving or resizing a measurement tool





18.2.1 General

You can move and resize a measurement tool.

18.2.2 Procedure

Note This procedure assumes that you have previously laid out a measurement tool on the screen.

Follow this procedure to move or resize a measurement tool:

1. Turn the mode wheel to  or .
2. Push the  button to display a menu.
3. Move the joystick left/right to go to the *Edit* tab.
4. Move the joystick up/down to select the measurement tool that you want to move or resize.
5. Push the joystick to display a menu.
6. Move the joystick up/down to select *Move* or *Resize*.
7. Move the joystick up/down and left/right to move or resize the measurement tool.
8. Push the joystick to confirm.
9. Push the  button to leave the setup mode.

18.3 Creating & setting up a difference calculation





18.3.1 General

A difference calculation returns the difference between the values of two known measurement results, or between the value of a measurement result and the reference temperature.

18.3.2 Procedure

Note This procedure assumes that you have previously laid out at least two measurement tools on the screen.

Follow this procedure to create and set up a difference calculation:

1. Turn the mode wheel to  or .
2. Push the  button to display a menu.
3. Move the joystick left/right to go to the *Edit* tab.
4. Move the joystick up/down to select *Add difference*.
5. Push the joystick to display a dialog box.
6. Do the following and push the joystick to confirm each choice:
 - 6.1. To select the *first* function in the difference calculation, select *Function 1* and push the joystick. Move the joystick up/down to select the measurement tool you want to use for this function.
 - 6.2. (Not applicable if there is only one measurement tool.) To select the ID of the measurement tool, select *Id* and push the joystick. Move the joystick up/down to select the ID.
 - 6.3. (Not applicable to spotmeter and reference temperature.) To select the result type of the measurement tool (*Min.*, *Max.*, *Avg.*), select *Type* and push the joystick. Move the joystick up/down to select the result type of the measurement tool.
7. Do the following and push the joystick to confirm each choice:
 - 7.1. To select the *second* function in the difference calculation, select *Function 2* and push the joystick. Move the joystick up/down to select the measurement tool you want to use for this function.
 - 7.2. (Not applicable if there is only one measurement tool.) To select the ID of the measurement tool, select *Id* and push the joystick. Move the joystick up/down to select the ID.
 - 7.3. (Not applicable to spotmeter.) To select the result type of the measurement tool (*Min.*, *Max.*, *Avg.*), select *Type* and push the joystick. Move the joystick up/down to select the result type of the measurement tool.
8. Push the  button to confirm and leave the setup mode.

18.4 Changing object parameters

18.4.1 General

For accurate measurements, you must set the object parameters. You can do this locally or globally. This procedure describes how to change the object parameters globally.

18.4.2 Types of parameters

The camera can use these object parameters:

- *Emissivity*, i.e., how much radiation an object emits, compared to the radiation of a theoretical reference object of the same temperature (called a “blackbody”). The opposite of emissivity is reflectivity. The emissivity determines how much of the radiation originates from the object as opposed to being reflected by it.

- *Reflected apparent temperature*, which is used when compensating for the radiation from the surroundings reflected by the object into the camera. This property of the object is called reflectivity.
- *Object distance*, i.e., the distance between the camera and the object of interest.
- *Atmospheric temperature*, i.e., the temperature of the air between the camera and the object of interest.
- *Relative humidity*, i.e., the relative humidity of the air between the camera and the object of interest.
- *External optics temperature*, i.e., the temperature of any protective windows etc. that are set up between the camera and the object of interest. If no protective window or protective shield is used, this value is irrelevant.
- *External optics transmission*, i.e., the optical transmission of any protective windows, etc. that are set up between the camera and the object of interest.

Note For furnace and other high-temperature applications, mount the heatshield on the camera. You must also enter the correct external optics transmission value of the heatshield into the camera. The external optics transmission value is printed on a label on the inside of the heatshield. You enter the external optics transmission value in the object parameters dialog on the *Edit* tab.

When you remove the heatshield you must reset the external optics transmission to 1.0.





18.4.3 Recommended values

If you are unsure about the values, the following values are recommended:

Emissivity	0.95
Distance	1.0 m (3.3 ft.)
Reflected apparent temperature	+20°C (+69°F)
Relative humidity	50%
Atmospheric temperature	+20°C (+69°F)

18.4.4 Procedure

Follow this procedure to change the object parameters globally:

1. Turn the mode wheel to  or .
2. Push the  button to display a menu.
3. Move the joystick left/right to go to the *Edit* tab.
4. Move the joystick up/down to select *Object parameters*.
5. Push the joystick to display a dialog box.
6. Move the joystick up/down to select the parameter you want to change, then push the joystick.
7. Move the joystick up/down to change the value, then push the joystick.
8. Push the  button to confirm and leave the setup mode.

Note

- Of the seven parameters above, *emissivity* and *reflected apparent temperature* are the two most important to set correctly in the camera.
- To change object parameters *locally*, first select a measurement tool in the toolbox, then select *Use local parameters*. Change the local parameters by selecting *Edit local parameters*, then edit them in the same way as for global object parameters.

18.4.5 Related topics

- For in-depth information about parameters, and how to correctly set emissivity and reflected apparent temperature, see 32 *Thermographic measurement techniques*.

19.1 General

You can program the camera to save images periodically.

19.2 Procedure

Follow this procedure to make the camera save images periodically:

1. Turn the mode wheel to . This will display the following dialog box:



2. Move the joystick up/down to select *Setup*.
3. Push the joystick. This will display the following dialog box:









4. Push the joystick.
5. Use the joystick to set the following:
 - The type of images to save (IR image, Digital photo, IR and digital).
 - The time period between which the camera will save an image (hours, minutes, seconds).
 - The stop condition (timer, counter, manual)
 - The timer or counter settings, if you selected one of these as stop condition.
6. Push the  button.
7. Move the joystick up/down to select *Start*.
8. Push the joystick to start the periodic saving.

20.1 General

You can record infrared or visual video clips (*.mp4), as well as radiometric video sequence files (*.seq). In this mode, the camera can be regarded as an ordinary digital video camera. The video clips can be edited and played back in FLIR VideoReport.

*.seq video clips can also be handled and edited in FLIR Reporter.

20.2 Procedure

1. Turn the mode wheel to .
2. Push the **S** button. The recording has now begun. A timer in the top right corner of the screen displays the elapsed recording time.
3. To stop the recording, push the **S** button. This will display a preview dialog box.
4. You can now do one or more of the following tasks before you save the video clip.
 - Select  to add a digital photo to the video clip. You turn on the digital camera lamps by pushing the joystick. Push the **S** button to take a digital photo.
 - Select  to play the video clip.
 - Select  to stop the playback of the video clip. This will also reset the playback counter to the beginning of the video clip.
 - Select  to pause/resume the playback of the video clip.
 - Select  to discard the video clip.
 - Select  to keep the video clip.



21.1 General

You can change a variety of settings for the camera:

- Regional settings, such as language, date, time, etc.
- Camera settings, such as digital camera color, display intensity, etc.
- Preferences, such as user-configurable buttons, image overlay information, text size, etc. Here you can also set the camera to stamp the temperature scale into the image.
- Camera information, such as serial number, part number, used and free memory, etc. No changes are possible here, only presentation of information.

21.2 Procedure

Follow this procedure to change settings:

1. Turn the mode wheel to  to enter setup mode.
2. Move the joystick left/right to go to the desired tab.
3. Move the joystick up/down to select the desired menu item.
4. Push the joystick. This will highlight a setting (or display a submenu, depending on the context).
5. Move the joystick up/down to change the setting.
6. Push the joystick to confirm the choice.
7. (To close a submenu, push the  button.)
8. To leave the setup mode, turn the mode wheel and select another mode.

21.3 Connecting the camera using a peer-to-peer (ad hoc) WLAN network

21.3.1 General

You can set up a *peer-to-peer* (ad hoc) WLAN network in order to let other devices connect to the camera.

Note

- This procedure shall be used when connecting the camera to Apple iPhone and iPad apps that are developed by FLIR Systems.
- The command Wi-Fi settings will only be available when a WLAN SD-Card, a USB-WLAN micro adapter, or a USB Wi-Fi micro adapter is inserted into the camera.

21.3.2 Procedure

Follow this procedure:

1. Insert a USB Wi-Fi micro adapter into the camera.
2. Turn on the camera.
3. Turn the mode wheel to .
4. In the toolbox, select *Camera*.
5. Under Wi-Fi, change the setting to Connect to device.

6. Under Wi-Fi settings, take note of the SSID parameter.
This is the unique identifier of the network and will be displayed in the list of available devices when you have set up the other device for WLAN communication.
7. Set up your other device for WLAN communication and select the camera (i.e., its SSID name).

21.3.3 Related topics

For locations of camera buttons, see 12 *Camera parts*, page 29.

21.4 Connecting the camera using a infrastructure WLAN network

21.4.1 General

You can set up a *infrastructure* WLAN network in order to communicate with other devices.

Note

- This procedure shall be used when connecting the camera to Android apps that are developed by FLIR Systems.
- Android phones and tablets can also be set up as Wi-Fi hotspots, to which you can connect the camera in the same way as you connect to a WLAN. Refer to the user documentation for your Android phone/tablet for more information.
- The command Wi-Fi settings will only be available when a WLAN SD-Card, a USB-WLAN micro adapter, or a USB Wi-Fi micro adapter is inserted into the camera.

21.4.2 Procedure

Follow this procedure:

1. Insert a USB Wi-Fi micro adapter into the camera.
2. Turn on the camera.
3. Turn the mode wheel to .
4. In the toolbox, select *Camera*.
5. Under Wi-Fi, change the setting to Connect to WLAN.
6. Under Wi-Fi settings, select the network that you want to connect to.
7. Set up your other device to connect to the WLAN network and select the camera (i.e., its SSID name).

21.4.3 Related topics

For locations of camera buttons, see 12 *Camera parts*.



21.5 Changing Wi-Fi settings

21.5.1 General

If you experience transmission or interference problems, you may need to change the Wi-Fi settings in the camera.

21.5.2 Procedure

Follow this procedure to change Wi-Fi settings:

1. Turn the mode wheel to .
2. In the toolbox, select *Camera*.
3. Select Wi-Fi settings and push the joystick.
4. To select a different channel, use the joystick. Push the joystick to confirm each choice. You can use channels 1 to 11. However, since the channels overlap, only channels 1, 6, and 11 are normally used.
5. In the other device, refresh the list of devices and try to connect to the camera again
6. To confirm and leave the dialog box, push the  button.

Note The command Wi-Fi settings will only be available when a WLAN SD-Card, a USB-WLAN micro adapter, or a USB Wi-Fi micro adapter is inserted into the camera.

21.5.3 Related topics

For locations of camera buttons, see 12 *Camera parts*.

Table of contents

22.1	Online field-of-view calculator	73
22.2	Note about technical data	73
22.3	Note about authoritative versions	74
22.4	FLIR GF300 14.5°	75
22.5	FLIR GF300 14.5° Fixed lens	80
22.6	FLIR GF300 24°	85
22.7	FLIR GF300 24° Fixed lens	90
22.8	FLIR GF304 14.5°	95
22.9	FLIR GF304 14.5° Fixed lens	101
22.10	FLIR GF304 24°	106
22.11	FLIR GF304 24° Fixed lens	112
22.12	FLIR GF306 14.5°	117
22.13	FLIR GF306 14.5° Fixed lens	123
22.14	FLIR GF306 24°	129
22.15	FLIR GF306 24° Fixed lens	135
22.16	FLIR GF309 14.5°	141
22.17	FLIR GF309 14.5° Fixed lens	147
22.18	FLIR GF309 24°	152
22.19	FLIR GF309 24° Fixed lens	158
22.20	FLIR GF320 14.5°	163
22.21	FLIR GF320 14.5° Fixed lens	169
22.22	FLIR GF320 24°	175
22.23	FLIR GF320 24° Fixed lens	181
22.24	FLIR GF335 24°	187
22.25	FLIR GF343 24° Fixed lens	192
22.26	FLIR GF346 14.5°	197
22.27	FLIR GF346 14.5° Fixed lens	203
22.28	FLIR GF346 24°	209
22.29	FLIR GF346 24° Fixed lens	215

22.1 Online field-of-view calculator

Please visit <http://support.flir.com> and click the photo of the camera series for field-of-view tables for all lens–camera combinations.

22.2 Note about technical data

FLIR Systems reserves the right to change specifications at any time without prior notice. Please check <http://support.flir.com> for latest changes.

22.3 Note about authoritative versions

The authoritative version of this publication is English. In the event of divergences due to translation errors, the English text has precedence.

Any late changes are first implemented in English.

22.4 FLIR GF300 14.5°

P/N: 44401-0201

Rev.: 45202

General description	
<p>The FLIR GF300 is an infrared camera for optical gas imaging (OGI) that visualizes and pinpoints leaks of methane and other volatile organic compounds (VOCs), without the need to shut down the operation. The portable camera also greatly improves operator safety, by detecting emissions at a safe distance, and helps to protect the environment by tracing leaks of environmentally harmful gases.</p> <p>The FLIR GF300 is used in industrial settings such as oil refineries, natural gas processing plants, off-shore platforms, chemical/petrochemical industries, and biogas and power generation plants.</p>	
Benefits:	
<ul style="list-style-type: none"> Improved efficiency: The FLIR GF300 reduces revenue loss by pinpointing even small gas leaks quickly and efficiently, and from a distance. It also reduces the inspection time by allowing a broad area to be scanned rapidly and without the need to interrupt the industrial process. Increased worker safety: OGI allows gas leaks to be detected in a non-contact mode and from a safe distance. This reduces the risk of the user being exposed to invisible and potentially harmful or explosive chemicals. With a FLIR GF300 gas imaging camera it is easy to scan areas of interest that are difficult to reach with conventional methods. The camera is ergonomically designed, with a bright LCD and tiltable viewfinder, which facilitates its use over a full working day. Protecting the environment: Several VOCs are dangerous to human health or cause harm to the environment, and are usually governed by regulations. Even small leaks can be detected and documented using the FLIR GF300 camera. 	
<p>Detects the following gases: benzene, ethanol, ethylbenzene, heptane, hexane, isoprene, methanol, MEK, MIBK, octane, pentane, 1-pentene, toluene, xylene, butane, ethane, methane, propane, ethylene, propylene.</p>	
Licensing and classification	
License information	Interchangeable lens version of the FLIR GF3XX series requires US Department of State License and will be subject to limitations on resale, except inside US. Allow a minimum of 90 days after application submittal for approval.
Imaging and optical data	
IR resolution	320 × 240 pixels
Thermal sensitivity/NETD	<15 mK @ +30°C (+86°F)
Field of view (FOV)	14.5° × 10.8°
Minimum focus distance	0.5 m (1.64 ft.)
Focal length	38 mm (1.49 in.)
Lens identification	Automatic
F-number	1.5
Focus	Automatic (one touch) or manual (electric or on the lens)
Zoom	1–8× continuous, digital zoom
Digital image enhancement	Noise reduction filter, high sensitivity mode (HSM)
Detector data	
Detector type	Focal plane array (FPA), cooled InSb
Spectral range	3.2–3.4 μm

Detector data	
Detector pitch	30 µm
Sensor cooling	Stirling Microcooler (FLIR MC-3)
Detects following gases	Benzene, Ethanol, Ethylbenzene, Heptane, Hexane, Isoprene, Methanol, MEK, MIBK, Octane, Pentane, 1-Pentene, Toluene, Xylene, Butane, Ethane, Methane, Propane, Ethylene, Propylene
Electronics and data rate	
Full frame rate	60 Hz
Image presentation	
Display	Built-in widescreen, 4.3 in. LCD, 800 × 480 pixels
Viewfinder	Built-in, tiltable OLED, 800 × 480 pixels
Automatic image adjustment	Continuous/manual; linear or histogram based
Manual image adjustment	Level/span
Image presentation modes	
Image modes	IR image, visual image, high sensitivity mode (HSM)
Measurement	
Temperature range	-20°C to +350°C (-4°F to +662°F)
Set-up	
Menu commands	Level, span Auto adjust continuous/manual/semi-automatic Zoom Palette Start/stop recording Store image Playback/recall image
Color palettes	Iron, Gray, Rainbow, Arctic, Lava, Rainbow HC
Set-up commands	1 programmable button, overlay recording mode, local adaptation of units, language, date and time formats
Storage of images	
Storage media	Removable SD or SDHC memory card , two card slots
Image storage capacity	> 1200 images (JPEG) with post process capability per GB on memory card
Image storage mode	IR/visual images Visual image can automatically be associated with corresponding IR image
Periodic image storage	Every 10 seconds up to 24 hours
File formats	Standard JPEG, 14 bit measurement data included

Geographic Information System	
GPS	Location data automatically added to every image from built-in GPS
Video recording in camera	
Radiometric IR video recording	*.seq video clips to memory card (7.5 and 15 Hz).
Non-radiometric IR video recording	MPEG4 (up to 60 minutes/clip) to memory card. Visual image can automatically be associated with corresponding recording of non-radiometric IR video.
Visual video recording	MPEG4 (25 minutes/clip) to memory card
Video streaming	
Radiometric IR video streaming	Full dynamic to PC using USB cable or to mobile devices using Wi-Fi. PC software capable of displaying the video stream include the following: <ul style="list-style-type: none"> • FLIR IR Camera Player • FLIR ResearchIR • FLIR Tools
Non-radiometric IR video streaming	RTP/MPEG4
Digital camera	
Built-in digital camera	3.2 Mpixels, auto focus, and two video lamps
Laser pointer	
Laser	Activated by dedicated button
Laser classification	Class 2
Laser type	Semiconductor AlGaInP diode laser, 1 mW, 635 nm (red)
USB	
USB	<ul style="list-style-type: none"> • USB-A: Connect external USB device • USB Mini-B: Data transfer to and from PC
USB, standard	USB Mini-B: 2.0 high speed
Composite video	
Video out	Digital video output (image)
Power system	
Battery type	Rechargeable Li ion battery
Battery voltage	7.2 V
Battery capacity	4.4 Ah
Battery operating time	> 3 hours at 25°C (+77°F) and typical use
Charging system	In camera (AC adapter or 12 V from a vehicle) or 2-bay charger
Charging time	2.5 h to 95% capacity, charging status indicated by LED's
External power operation	AC adapter 90–260 VAC, 50/60 Hz or 12 V from a vehicle (cable with standard plug, optional)
DC operation	10.8 to 16 V DC, polarity protected (proprietary protected)

Power system	
Power	8.5 W typically
Start-up time	Typically 7 min. @ 25°C (+77°F)
Environmental data	
Operating temperature range	-20°C to +50°C (-4°F to +122°F)
Storage temperature range	-30°C to +60°C (-22°F to +140°F)
Humidity (operating and storage)	IEC 68-2-30/24 h 95% relative humidity +25°C to +40°C (+77°F to +104°F) (2 cycles)
Directives	<ul style="list-style-type: none"> • 73/23EEC • 2004/108/EC • 2002/95/EC • 2002/96/EC
EMC	<ul style="list-style-type: none"> • EN61000-6-4 (Emission) • EN61000-6-2 (Immunity) • FCC 47 CFR Part 15 class A (Emission) • EN 61 000-4-8, L5
Encapsulation	IP 54 (IEC 60529)
Shock	25 g (IEC 60068-2-27)
Vibration	2 g (IEC 60068-2-6)
Safety	Power supply: EN/UL/IEC 60950-1
Physical data	
Camera weight, excl. lens and battery	1.94 kg (4.27 lb.)
Camera weight, incl. lens and excl. battery	2.24 kg (4.94 lb.)
Camera weight, incl. lens and battery	2.48 kg (5.47 lb.)
Battery weight	0.24 kg (0.52 lb.)
Camera size, excl. lens (L × W × H)	284 × 169 × 161 mm (11.2 × 6.7 × 6.3 in.)
Cameras size, incl. lens (L × W × H)	305 × 169 × 161 mm (12.0 × 6.7 × 6.3 in.)
Battery size (L × W × H)	141 × 47 × 28 mm (5.5 × 1.8 × 1.1 in.)
Battery charger size (L × W × H)	158 × 122 × 25 mm (6.2 × 4.8 × 1.0 in.)
Tripod mounting	UNC ¼"-20
Housing material	Aluminum, magnesium
Grip material	TPE thermoplastic elastomers

Shipping information	
Packaging, type	Cardboard box
List of contents	<ul style="list-style-type: none"> • Infrared camera with lens • Battery charger • Battery, 2 ea. • Hard transport case • HDMI-DVI cable • HDMI-HDMI cable • Lens cap (2 ea.) • Lens cap (mounted on lens) • Memory card • Power supply, incl. multi-plugs • Printed documentation • Shoulder strap • USB cable
Packaging, weight	
Packaging, size	400 × 190 × 510 mm (15.7 × 7.5 × 20.1 in.)
EAN-13	7332558002704
UPC-12	845188001964
Country of origin	Sweden

Supplies & accessories:

- T197387; IR lens, 24° with case for GF300, GF309, GF320
- T197388; IR lens, 6° with case for GF300, GF309, GF320, GF346.
- T197385; IR lens, 14.5° with case for GF300, GF309, GF320
- T197692; Battery charger, incl. power supply with multi plugs
- T910814; Power supply, incl. multi plugs
- T198511; Li-Ion Battery pack 7.4V 33Wh
- T199367ACC; Battery Li-ion 7.2 V, 4.4 Ah, 32 Wh
- T911650ACC; Memory card SD Card 8 GB
- 1910423; USB cable Std A <-> Mini-B
- T198509; Cigarette lighter adapter kit, 12 VDC, 1.2 m/3.9 ft.
- T910815ACC; HDMI to HDMI cable 1.5 m
- T910816ACC; HDMI to DVI cable 1.5 m
- T197555; Hard transport case for FLIR GF3xx-Series
- T198585; FLIR VideoReport
- DSW-10000; FLIR IR Camera Player
- T199233; FLIR Atlas SDK for .NET
- T199234; FLIR Atlas SDK for MATLAB
- T198567; ThermoVision™ System Developers Kit Ver. 2.6
- T198566; ThermoVision™ LabVIEW® Digital Toolkit Ver. 3.3

22.5 FLIR GF300 14.5° Fixed lens

P/N: 44402-0201

Rev.: 45202

General description	
<p>The FLIR GF300 is an infrared camera for optical gas imaging (OGI) that visualizes and pinpoints leaks of methane and other volatile organic compounds (VOCs), without the need to shut down the operation. The portable camera also greatly improves operator safety, by detecting emissions at a safe distance, and helps to protect the environment by tracing leaks of environmentally harmful gases.</p> <p>The FLIR GF300 is used in industrial settings such as oil refineries, natural gas processing plants, off-shore platforms, chemical/petrochemical industries, and biogas and power generation plants.</p>	
Benefits:	
<ul style="list-style-type: none"> • Improved efficiency: The FLIR GF300 reduces revenue loss by pinpointing even small gas leaks quickly and efficiently, and from a distance. It also reduces the inspection time by allowing a broad area to be scanned rapidly and without the need to interrupt the industrial process. • Increased worker safety: OGI allows gas leaks to be detected in a non-contact mode and from a safe distance. This reduces the risk of the user being exposed to invisible and potentially harmful or explosive chemicals. With a FLIR GF300 gas imaging camera it is easy to scan areas of interest that are difficult to reach with conventional methods. The camera is ergonomically designed, with a bright LCD and tiltable viewfinder, which facilitates its use over a full working day. • Protecting the environment: Several VOCs are dangerous to human health or cause harm to the environment, and are usually governed by regulations. Even small leaks can be detected and documented using the FLIR GF300 camera. 	
<p>Detects the following gases: benzene, ethanol, ethylbenzene, heptane, hexane, isoprene, methanol, MEK, MIBK, octane, pentane, 1-pentene, toluene, xylene, butane, ethane, methane, propane, ethylene, propylene.</p>	
Imaging and optical data	
IR resolution	320 × 240 pixels
Thermal sensitivity/NETD	<15 mK @ +30°C (+86°F)
Field of view (FOV)	14.5° × 10.8°
Minimum focus distance	0.5 m (1.64 ft.)
Focal length	38 mm (1.49 in.)
Lens identification	Automatic
F-number	1.5
Focus	Automatic (one touch) or manual (electric or on the lens)
Zoom	1–8× continuous, digital zoom
Digital image enhancement	Noise reduction filter, high sensitivity mode (HSM)
Detector data	
Detector type	Focal plane array (FPA), cooled InSb
Spectral range	3.2–3.4 μm
Detector pitch	30 μm
Sensor cooling	Stirling Microcooler (FLIR MC-3)
Detects following gases	Benzene, Ethanol, Ethylbenzene, Heptane, Hexane, Isoprene, Methanol, MEK, MIBK, Octane, Pentane, 1-Pentene, Toluene, Xylene, Butane, Ethane, Methane, Propane, Ethylene, Propylene

Electronics and data rate	
Full frame rate	60 Hz
Image presentation	
Display	Built-in widescreen, 4.3 in. LCD, 800 × 480 pixels
Viewfinder	Built-in, tiltable OLED, 800 × 480 pixels
Automatic image adjustment	Continuous/manual; linear or histogram based
Manual image adjustment	Level/span
Image presentation modes	
Image modes	IR image, visual image, high sensitivity mode (HSM)
Measurement	
Temperature range	-20°C to +350°C (-4°F to +662°F)
Set-up	
Menu commands	Level, span Auto adjust continuous/manual/semi-automatic Zoom Palette Start/stop recording Store image Playback/recall image
Color palettes	Iron, Gray, Rainbow, Arctic, Lava, Rainbow HC
Set-up commands	1 programmable button, overlay recording mode, local adaptation of units, language, date and time formats
Storage of images	
Storage media	Removable SD or SDHC memory card , two card slots
Image storage capacity	> 1200 images (JPEG) with post process capability per GB on memory card
Image storage mode	IR/visual images Visual image can automatically be associated with corresponding IR image
Periodic image storage	Every 10 seconds up to 24 hours
File formats	Standard JPEG, 14 bit measurement data included
Geographic Information System	
GPS	Location data automatically added to every image from built-in GPS

Video recording in camera	
Radiometric IR video recording	*.seq video clips to memory card (7.5 and 15 Hz).
Non-radiometric IR video recording	MPEG4 (up to 60 minutes/clip) to memory card. Visual image can automatically be associated with corresponding recording of non-radiometric IR video.
Visual video recording	MPEG4 (25 minutes/clip) to memory card
Video streaming	
Radiometric IR video streaming	Full dynamic to PC using USB cable or to mobile devices using Wi-Fi. PC software capable of displaying the video stream include the following: <ul style="list-style-type: none"> • FLIR IR Camera Player • FLIR ResearchIR • FLIR Tools
Non-radiometric IR video streaming	RTP/MPEG4
Digital camera	
Built-in digital camera	3.2 Mpixels, auto focus, and two video lamps
Laser pointer	
Laser	Activated by dedicated button
Laser classification	Class 2
Laser type	Semiconductor AlGaInP diode laser, 1 mW, 635 nm (red)
USB	
USB	<ul style="list-style-type: none"> • USB-A: Connect external USB device • USB Mini-B: Data transfer to and from PC
USB, standard	USB Mini-B: 2.0 high speed
Composite video	
Video out	Digital video output (image)
Power system	
Battery type	Rechargeable Li ion battery
Battery voltage	7.2 V
Battery capacity	4.4 Ah
Battery operating time	> 3 hours at 25°C (+77°F) and typical use
Charging system	In camera (AC adapter or 12 V from a vehicle) or 2-bay charger
Charging time	2.5 h to 95% capacity, charging status indicated by LED's
External power operation	AC adapter 90–260 VAC, 50/60 Hz or 12 V from a vehicle (cable with standard plug, optional)
DC operation	10.8 to 16 V DC, polarity protected (proprietary protected)
Power	8.5 W typically
Start-up time	Typically 7 min. @ 25°C (+77°F)

Environmental data	
Operating temperature range	-20°C to +50°C (-4°F to +122°F)
Storage temperature range	-30°C to +60°C (-22°F to +140°F)
Humidity (operating and storage)	IEC 68-2-30/24 h 95% relative humidity +25°C to +40°C (+77°F to +104°F) (2 cycles)
Directives	<ul style="list-style-type: none"> • 73/23EEC • 2004/108/EC • 2002/95/EC • 2002/96/EC
EMC	<ul style="list-style-type: none"> • EN61000-6-4 (Emission) • EN61000-6-2 (Immunity) • FCC 47 CFR Part 15 class A (Emission) • EN 61 000-4-8, L5
Encapsulation	IP 54 (IEC 60529)
Shock	25 g (IEC 60068-2-27)
Vibration	2 g (IEC 60068-2-6)
Safety	Power supply: EN/UL/IEC 60950-1
Physical data	
Camera weight, excl. lens and battery	1.94 kg (4.27 lb.)
Camera weight, incl. lens and excl. battery	2.24 kg (4.94 lb.)
Camera weight, incl. lens and battery	2.48 kg (5.47 lb.)
Battery weight	0.24 kg (0.52 lb.)
Camera size, excl. lens (L × W × H)	284 × 169 × 161 mm (11.2 × 6.7 × 6.3 in.)
Cameras size, incl. lens (L × W × H)	305 × 169 × 161 mm (12.0 × 6.7 × 6.3 in.)
Battery size (L × W × H)	141 × 47 × 28 mm (5.5 × 1.8 × 1.1 in.)
Battery charger size (L × W × H)	158 × 122 × 25 mm (6.2 × 4.8 × 1.0 in.)
Tripod mounting	UNC ¼"-20
Housing material	Aluminum, magnesium
Grip material	TPE thermoplastic elastomers
Shipping information	
Packaging, type	Cardboard box
List of contents	<ul style="list-style-type: none"> • Infrared camera with lens • Battery charger • Battery, 2 ea. • Hard transport case • HDMI-DVI cable • HDMI-HDMI cable • Lens cap (mounted on lens) • Memory card • Power supply, incl. multi-plugs • Printed documentation • Shoulder strap • USB cable
Packaging, weight	
Packaging, size	400 × 190 × 510 mm (15.7 × 7.5 × 20.1 in.)
EAN-13	7332558002711

Shipping information	
UPC-12	845188001971
Country of origin	Sweden

Supplies & accessories:

- T197692; Battery charger, incl. power supply with multi plugs
- T910814; Power supply, incl. multi plugs
- T198511; Li-Ion Battery pack 7.4V 33Wh
- T199367ACC; Battery Li-ion 7.2 V, 4.4 Ah, 32 Wh
- T911650ACC; Memory card SD Card 8 GB
- 1910423; USB cable Std A <-> Mini-B
- T198509; Cigarette lighter adapter kit, 12 VDC, 1.2 m/3.9 ft.
- T910815ACC; HDMI to HDMI cable 1.5 m
- T910816ACC; HDMI to DVI cable 1.5 m
- T197555; Hard transport case for FLIR GF3xx-Series
- T198585; FLIR VideoReport
- DSW-10000; FLIR IR Camera Player
- T199233; FLIR Atlas SDK for .NET
- T199234; FLIR Atlas SDK for MATLAB
- T198567; ThermoVision™ System Developers Kit Ver. 2.6
- T198566; ThermoVision™ LabVIEW® Digital Toolkit Ver. 3.3

22.6 FLIR GF300 24°

P/N: 44401-0202

Rev.: 45202

General description	
<p>The FLIR GF300 is an infrared camera for optical gas imaging (OGI) that visualizes and pinpoints leaks of methane and other volatile organic compounds (VOCs), without the need to shut down the operation. The portable camera also greatly improves operator safety, by detecting emissions at a safe distance, and helps to protect the environment by tracing leaks of environmentally harmful gases.</p> <p>The FLIR GF300 is used in industrial settings such as oil refineries, natural gas processing plants, off-shore platforms, chemical/petrochemical industries, and biogas and power generation plants.</p>	
Benefits:	
<ul style="list-style-type: none"> Improved efficiency: The FLIR GF300 reduces revenue loss by pinpointing even small gas leaks quickly and efficiently, and from a distance. It also reduces the inspection time by allowing a broad area to be scanned rapidly and without the need to interrupt the industrial process. Increased worker safety: OGI allows gas leaks to be detected in a non-contact mode and from a safe distance. This reduces the risk of the user being exposed to invisible and potentially harmful or explosive chemicals. With a FLIR GF300 gas imaging camera it is easy to scan areas of interest that are difficult to reach with conventional methods. The camera is ergonomically designed, with a bright LCD and tiltable viewfinder, which facilitates its use over a full working day. Protecting the environment: Several VOCs are dangerous to human health or cause harm to the environment, and are usually governed by regulations. Even small leaks can be detected and documented using the FLIR GF300 camera. 	
<p>Detects the following gases: benzene, ethanol, ethylbenzene, heptane, hexane, isoprene, methanol, MEK, MIBK, octane, pentane, 1-pentene, toluene, xylene, butane, ethane, methane, propane, ethylene, propylene.</p>	
Licensing and classification	
License information	Interchangeable lens version of the FLIR GF3XX series requires US Department of State License and will be subject to limitations on resale, except inside US. Allow a minimum of 90 days after application submittal for approval.
Imaging and optical data	
IR resolution	320 × 240 pixels
Thermal sensitivity/NETD	<15 mK @ +30°C (+86°F)
Field of view (FOV)	24° × 18°
Minimum focus distance	0.3 m (1.0 ft.)
Focal length	23 mm (0.89 in.)
Lens identification	Automatic
F-number	1.5
Focus	Automatic (one touch) or manual (electric or on the lens)
Zoom	1–8× continuous, digital zoom
Digital image enhancement	Noise reduction filter, high sensitivity mode (HSM)
Detector data	
Detector type	Focal plane array (FPA), cooled InSb
Spectral range	3.2–3.4 μm

Detector data	
Detector pitch	30 µm
Sensor cooling	Stirling Microcooler (FLIR MC-3)
Detects following gases	Benzene, Ethanol, Ethylbenzene, Heptane, Hexane, Isoprene, Methanol, MEK, MIBK, Octane, Pentane, 1-Pentene, Toluene, Xylene, Butane, Ethane, Methane, Propane, Ethylene, Propylene
Electronics and data rate	
Full frame rate	60 Hz
Image presentation	
Display	Built-in widescreen, 4.3 in. LCD, 800 × 480 pixels
Viewfinder	Built-in, tiltable OLED, 800 × 480 pixels
Automatic image adjustment	Continuous/manual; linear or histogram based
Manual image adjustment	Level/span
Image presentation modes	
Image modes	IR image, visual image, high sensitivity mode (HSM)
Measurement	
Temperature range	-20°C to +350°C (-4°F to +662°F)
Set-up	
Menu commands	Level, span Auto adjust continuous/manual/semi-automatic Zoom Palette Start/stop recording Store image Playback/recall image
Color palettes	Iron, Gray, Rainbow, Arctic, Lava, Rainbow HC
Set-up commands	1 programmable button, overlay recording mode, local adaptation of units, language, date and time formats
Storage of images	
Storage media	Removable SD or SDHC memory card , two card slots
Image storage capacity	> 1200 images (JPEG) with post process capability per GB on memory card
Image storage mode	IR/visual images Visual image can automatically be associated with corresponding IR image
Periodic image storage	Every 10 seconds up to 24 hours
File formats	Standard JPEG, 14 bit measurement data included

Geographic Information System	
GPS	Location data automatically added to every image from built-in GPS
Video recording in camera	
Radiometric IR video recording	*.seq video clips to memory card (7.5 and 15 Hz).
Non-radiometric IR video recording	MPEG4 (up to 60 minutes/clip) to memory card. Visual image can automatically be associated with corresponding recording of non-radiometric IR video.
Visual video recording	MPEG4 (25 minutes/clip) to memory card
Video streaming	
Radiometric IR video streaming	Full dynamic to PC using USB cable or to mobile devices using Wi-Fi. PC software capable of displaying the video stream include the following: <ul style="list-style-type: none"> • FLIR IR Camera Player • FLIR ResearchIR • FLIR Tools
Non-radiometric IR video streaming	RTP/MPEG4
Digital camera	
Built-in digital camera	3.2 Mpixels, auto focus, and two video lamps
Laser pointer	
Laser	Activated by dedicated button
Laser classification	Class 2
Laser type	Semiconductor AlGaInP diode laser, 1 mW, 635 nm (red)
USB	
USB	<ul style="list-style-type: none"> • USB-A: Connect external USB device • USB Mini-B: Data transfer to and from PC
USB, standard	USB Mini-B: 2.0 high speed
Composite video	
Video out	Digital video output (image)
Power system	
Battery type	Rechargeable Li ion battery
Battery voltage	7.2 V
Battery capacity	4.4 Ah
Battery operating time	> 3 hours at 25°C (+77°F) and typical use
Charging system	In camera (AC adapter or 12 V from a vehicle) or 2-bay charger
Charging time	2.5 h to 95% capacity, charging status indicated by LED's
External power operation	AC adapter 90–260 VAC, 50/60 Hz or 12 V from a vehicle (cable with standard plug, optional)
DC operation	10.8 to 16 V DC, polarity protected (proprietary protected)

Power system	
Power	8.5 W typically
Start-up time	Typically 7 min. @ 25°C (+77°F)
Environmental data	
Operating temperature range	-20°C to +50°C (-4°F to +122°F)
Storage temperature range	-30°C to +60°C (-22°F to +140°F)
Humidity (operating and storage)	IEC 68-2-30/24 h 95% relative humidity +25°C to +40°C (+77°F to +104°F) (2 cycles)
Directives	<ul style="list-style-type: none"> • 73/23EEC • 2004/108/EC • 2002/95/EC • 2002/96/EC
EMC	<ul style="list-style-type: none"> • EN61000-6-4 (Emission) • EN61000-6-2 (Immunity) • FCC 47 CFR Part 15 class A (Emission) • EN 61 000-4-8, L5
Encapsulation	IP 54 (IEC 60529)
Shock	25 g (IEC 60068-2-27)
Vibration	2 g (IEC 60068-2-6)
Safety	Power supply: EN/UL/IEC 60950-1
Physical data	
Camera weight, excl. lens and battery	1.94 kg (4.27 lb.)
Camera weight, incl. lens and excl. battery	2.24 kg (4.94 lb.)
Camera weight, incl. lens and battery	2.48 kg (5.47 lb.)
Battery weight	0.24 kg (0.52 lb.)
Camera size, excl. lens (L × W × H)	284 × 169 × 161 mm (11.2 × 6.7 × 6.3 in.)
Cameras size, incl. lens (L × W × H)	306 × 169 × 161 mm (12.0 × 6.7 × 6.3 in.)
Battery size (L × W × H)	141 × 47 × 28 mm (5.5 × 1.8 × 1.1 in.)
Battery charger size (L × W × H)	158 × 122 × 25 mm (6.2 × 4.8 × 1.0 in.)
Tripod mounting	UNC ¼"-20
Housing material	Aluminum, magnesium
Grip material	TPE thermoplastic elastomers

Shipping information	
Packaging, type	Cardboard box
List of contents	<ul style="list-style-type: none"> • Infrared camera with lens • Battery charger • Battery, 2 ea. • Hard transport case • HDMI-DVI cable • HDMI-HDMI cable • Lens cap (2 ea.) • Lens cap (mounted on lens) • Memory card • Power supply, incl. multi-plugs • Printed documentation • Shoulder strap • USB cable
Packaging, weight	
Packaging, size	400 × 190 × 510 mm (15.7 × 7.5 × 20.1 in.)
EAN-13	7332558002728
UPC-12	845188001988
Country of origin	Sweden

Supplies & accessories:

- T197387; IR lens, 24° with case for GF300, GF309, GF320
- T197388; IR lens, 6° with case for GF300, GF309, GF320, GF346.
- T197385; IR lens, 14.5° with case for GF300, GF309, GF320
- T197692; Battery charger, incl. power supply with multi plugs
- T910814; Power supply, incl. multi plugs
- T198511; Li-Ion Battery pack 7.4V 33Wh
- T199367ACC; Battery Li-ion 7.2 V, 4.4 Ah, 32 Wh
- T911650ACC; Memory card SD Card 8 GB
- 1910423; USB cable Std A <-> Mini-B
- T198509; Cigarette lighter adapter kit, 12 VDC, 1.2 m/3.9 ft.
- T910815ACC; HDMI to HDMI cable 1.5 m
- T910816ACC; HDMI to DVI cable 1.5 m
- T197555; Hard transport case for FLIR GF3xx-Series
- T198585; FLIR VideoReport
- DSW-10000; FLIR IR Camera Player
- T199233; FLIR Atlas SDK for .NET
- T199234; FLIR Atlas SDK for MATLAB
- T198567; ThermoVision™ System Developers Kit Ver. 2.6
- T198566; ThermoVision™ LabVIEW® Digital Toolkit Ver. 3.3

22.7 FLIR GF300 24° Fixed lens

P/N: 44402-0202

Rev.: 45202

General description	
<p>The FLIR GF300 is an infrared camera for optical gas imaging (OGI) that visualizes and pinpoints leaks of methane and other volatile organic compounds (VOCs), without the need to shut down the operation. The portable camera also greatly improves operator safety, by detecting emissions at a safe distance, and helps to protect the environment by tracing leaks of environmentally harmful gases.</p> <p>The FLIR GF300 is used in industrial settings such as oil refineries, natural gas processing plants, off-shore platforms, chemical/petrochemical industries, and biogas and power generation plants.</p>	
Benefits:	
<ul style="list-style-type: none"> • Improved efficiency: The FLIR GF300 reduces revenue loss by pinpointing even small gas leaks quickly and efficiently, and from a distance. It also reduces the inspection time by allowing a broad area to be scanned rapidly and without the need to interrupt the industrial process. • Increased worker safety: OGI allows gas leaks to be detected in a non-contact mode and from a safe distance. This reduces the risk of the user being exposed to invisible and potentially harmful or explosive chemicals. With a FLIR GF300 gas imaging camera it is easy to scan areas of interest that are difficult to reach with conventional methods. The camera is ergonomically designed, with a bright LCD and tiltable viewfinder, which facilitates its use over a full working day. • Protecting the environment: Several VOCs are dangerous to human health or cause harm to the environment, and are usually governed by regulations. Even small leaks can be detected and documented using the FLIR GF300 camera. 	
<p>Detects the following gases: benzene, ethanol, ethylbenzene, heptane, hexane, isoprene, methanol, MEK, MIBK, octane, pentane, 1-pentene, toluene, xylene, butane, ethane, methane, propane, ethylene, propylene.</p>	
Imaging and optical data	
IR resolution	320 × 240 pixels
Thermal sensitivity/NETD	<15 mK @ +30°C (+86°F)
Field of view (FOV)	24° × 18°
Minimum focus distance	0.3 m (1.0 ft.)
Focal length	23 mm (0.89 in.)
Lens identification	Automatic
F-number	1.5
Focus	Automatic (one touch) or manual (electric or on the lens)
Zoom	1–8× continuous, digital zoom
Digital image enhancement	Noise reduction filter, high sensitivity mode (HSM)
Detector data	
Detector type	Focal plane array (FPA), cooled InSb
Spectral range	3.2–3.4 μm
Detector pitch	30 μm
Sensor cooling	Stirling Microcooler (FLIR MC-3)
Detects following gases	Benzene, Ethanol, Ethylbenzene, Heptane, Hexane, Isoprene, Methanol, MEK, MIBK, Octane, Pentane, 1-Pentene, Toluene, Xylene, Butane, Ethane, Methane, Propane, Ethylene, Propylene

Electronics and data rate	
Full frame rate	60 Hz
Image presentation	
Display	Built-in widescreen, 4.3 in. LCD, 800 × 480 pixels
Viewfinder	Built-in, tiltable OLED, 800 × 480 pixels
Automatic image adjustment	Continuous/manual; linear or histogram based
Manual image adjustment	Level/span
Image presentation modes	
Image modes	IR image, visual image, high sensitivity mode (HSM)
Measurement	
Temperature range	-20°C to +350°C (-4°F to +662°F)
Set-up	
Menu commands	Level, span Auto adjust continuous/manual/semi-automatic Zoom Palette Start/stop recording Store image Playback/recall image
Color palettes	Iron, Gray, Rainbow, Arctic, Lava, Rainbow HC
Set-up commands	1 programmable button, overlay recording mode, local adaptation of units, language, date and time formats
Storage of images	
Storage media	Removable SD or SDHC memory card , two card slots
Image storage capacity	> 1200 images (JPEG) with post process capability per GB on memory card
Image storage mode	IR/visual images Visual image can automatically be associated with corresponding IR image
Periodic image storage	Every 10 seconds up to 24 hours
File formats	Standard JPEG, 14 bit measurement data included
Geographic Information System	
GPS	Location data automatically added to every image from built-in GPS

Video recording in camera	
Radiometric IR video recording	*.seq video clips to memory card (7.5 and 15 Hz).
Non-radiometric IR video recording	MPEG4 (up to 60 minutes/clip) to memory card. Visual image can automatically be associated with corresponding recording of non-radiometric IR video.
Visual video recording	MPEG4 (25 minutes/clip) to memory card
Video streaming	
Radiometric IR video streaming	Full dynamic to PC using USB cable or to mobile devices using Wi-Fi. PC software capable of displaying the video stream include the following: <ul style="list-style-type: none"> • FLIR IR Camera Player • FLIR ResearchIR • FLIR Tools
Non-radiometric IR video streaming	RTP/MPEG4
Digital camera	
Built-in digital camera	3.2 Mpixels, auto focus, and two video lamps
Laser pointer	
Laser	Activated by dedicated button
Laser classification	Class 2
Laser type	Semiconductor AlGaInP diode laser, 1 mW, 635 nm (red)
USB	
USB	<ul style="list-style-type: none"> • USB-A: Connect external USB device • USB Mini-B: Data transfer to and from PC
USB, standard	USB Mini-B: 2.0 high speed
Composite video	
Video out	Digital video output (image)
Power system	
Battery type	Rechargeable Li ion battery
Battery voltage	7.2 V
Battery capacity	4.4 Ah
Battery operating time	> 3 hours at 25°C (+77°F) and typical use
Charging system	In camera (AC adapter or 12 V from a vehicle) or 2-bay charger
Charging time	2.5 h to 95% capacity, charging status indicated by LED's
External power operation	AC adapter 90–260 VAC, 50/60 Hz or 12 V from a vehicle (cable with standard plug, optional)
DC operation	10.8 to 16 V DC, polarity protected (proprietary protected)
Power	8.5 W typically
Start-up time	Typically 7 min. @ 25°C (+77°F)

Environmental data	
Operating temperature range	-20°C to +50°C (-4°F to +122°F)
Storage temperature range	-30°C to +60°C (-22°F to +140°F)
Humidity (operating and storage)	IEC 68-2-30/24 h 95% relative humidity +25°C to +40°C (+77°F to +104°F) (2 cycles)
Directives	<ul style="list-style-type: none"> • 73/23EEC • 2004/108/EC • 2002/95/EC • 2002/96/EC
EMC	<ul style="list-style-type: none"> • EN61000-6-4 (Emission) • EN61000-6-2 (Immunity) • FCC 47 CFR Part 15 class A (Emission) • EN 61 000-4-8, L5
Encapsulation	IP 54 (IEC 60529)
Shock	25 g (IEC 60068-2-27)
Vibration	2 g (IEC 60068-2-6)
Safety	Power supply: EN/UL/IEC 60950-1
Physical data	
Camera weight, excl. lens and battery	1.94 kg (4.27 lb.)
Camera weight, incl. lens and excl. battery	2.24 kg (4.94 lb.)
Camera weight, incl. lens and battery	2.48 kg (5.47 lb.)
Battery weight	0.24 kg (0.52 lb.)
Camera size, excl. lens (L × W × H)	284 × 169 × 161 mm (11.2 × 6.7 × 6.3 in.)
Cameras size, incl. lens (L × W × H)	306 × 169 × 161 mm (12.0 × 6.7 × 6.3 in.)
Battery size (L × W × H)	141 × 47 × 28 mm (5.5 × 1.8 × 1.1 in.)
Battery charger size (L × W × H)	158 × 122 × 25 mm (6.2 × 4.8 × 1.0 in.)
Tripod mounting	UNC ¼"-20
Housing material	Aluminum, magnesium
Grip material	TPE thermoplastic elastomers
Shipping information	
Packaging, type	Cardboard box
List of contents	<ul style="list-style-type: none"> • Infrared camera with lens • Battery charger • Battery, 2 ea. • Hard transport case • HDMI-DVI cable • HDMI-HDMI cable • Lens cap (mounted on lens) • Memory card • Power supply, incl. multi-plugs • Printed documentation • Shoulder strap • USB cable
Packaging, weight	
Packaging, size	400 × 190 × 510 mm (15.7 × 7.5 × 20.1 in.)
EAN-13	7332558002735

Shipping information	
UPC-12	845188001995
Country of origin	Sweden

Supplies & accessories:

- T197692; Battery charger, incl. power supply with multi plugs
- T910814; Power supply, incl. multi plugs
- T198511; Li-Ion Battery pack 7.4V 33Wh
- T199367ACC; Battery Li-ion 7.2 V, 4.4 Ah, 32 Wh
- T911650ACC; Memory card SD Card 8 GB
- 1910423; USB cable Std A <-> Mini-B
- T198509; Cigarette lighter adapter kit, 12 VDC, 1.2 m/3.9 ft.
- T910815ACC; HDMI to HDMI cable 1.5 m
- T910816ACC; HDMI to DVI cable 1.5 m
- T197555; Hard transport case for FLIR GF3xx-Series
- T198585; FLIR VideoReport
- DSW-10000; FLIR IR Camera Player
- T199233; FLIR Atlas SDK for .NET
- T199234; FLIR Atlas SDK for MATLAB
- T198567; ThermoVision™ System Developers Kit Ver. 2.6
- T198566; ThermoVision™ LabVIEW® Digital Toolkit Ver. 3.3

22.8 FLIR GF304 14.5°

P/N: 59601-0101

Rev.: 45202

General description	
<p>The FLIR GF304 is an infrared camera for optical gas imaging (OGI) that visualizes and pinpoints leaks of refrigerant gases, without the need to shut down the operation. This portable camera also greatly improves operator safety, by detecting gases at a safe distance, and helps to protect the environment by tracing leaks of environmentally harmful gases.</p> <p>Refrigerant gases are found in, for example, the food, chemical/petrochemical, and automotive industries, as well as in air-conditioning systems.</p>	
Benefits:	
<ul style="list-style-type: none"> Improved efficiency: The FLIR GF304 reduces revenue loss by pinpointing even small gas leaks quickly and efficiently, and from a distance. It also reduces the inspection time by being able to scan a broad area rapidly without the need to interrupt the industrial process. The wireless connectivity of the camera allows you to connect to smart phones or tablets for the wireless transfer of images or the remote control of the camera. The FLIR GF304 can also be used for temperature measurement, which makes it even more useful for predictive maintenance. Increased worker safety: The leak detection of gases can be performed in non-contact mode, and from a safe distance. This reduces the risk of the user being exposed to invisible and potentially harmful or explosive chemicals. With a FLIR GF304 gas-imaging camera it is easy to scan areas of interest that are difficult to reach with conventional methods. The camera is ergonomically designed, with a bright LCD and a tiltable viewfinder, which facilitates its use over a full working day. Protecting the environment: Several refrigerant gases have a high global warming potential and are usually governed by regulations. Even small leaks can be detected and documented using the FLIR GF304 camera. 	
<p>Detects the following refrigerant gases: R404A, R407C, R410A, R134A, R417A, R422A, R507A, R143A, R125, R245fa.</p>	
Licensing and classification	
License information	Interchangeable lens version of the FLIR GF3XX series requires US Department of State License and will be subject to limitations on resale, except inside US. Allow a minimum of 90 days after application submittal for approval.
Imaging and optical data	
IR resolution	320 × 240 pixels
Thermal sensitivity/NETD	<15 mK @ +30°C (+86°F)
Field of view (FOV)	14.5° × 10.8°
Minimum focus distance	0.5 m (1.64 ft.)
Focal length	38 mm (1.49 in.)
Lens identification	Automatic
F-number	1.5
Focus	Automatic (one touch) or manual (electric or on the lens)
Zoom	1–8x continuous, digital zoom
Digital image enhancement	Noise reduction filter, high sensitivity mode (HSM)

Detector data	
Detector type	Focal plane array (FPA), cooled QWIP
Spectral range	8.0–8.6 μm
Detector pitch	30 μm
Sensor cooling	Stirling Microcooler (FLIR MC-3)
Detects following gases	R404A, R407C, R410A, R417A, R422A, R507A, R143A, R125, R134A, R245fa
Electronics and data rate	
Full frame rate	60 Hz
Image presentation	
Display	Built-in widescreen, 4.3 in. LCD, 800 × 480 pixels
Viewfinder	Built-in, tiltable OLED, 800 × 480 pixels
Automatic image adjustment	Continuous/manual; linear or histogram based
Manual image adjustment	Level/span
Image presentation modes	
Image modes	IR image, visual image, high sensitivity mode (HSM)
Measurement	
Temperature range	-20°C to +250°C (-4°F to +482°F)
Accuracy	$\pm 1^\circ\text{C}$ ($\pm 1.8^\circ\text{F}$) for temperature range (0°C, to +100°C, +32°F to +212°F) or $\pm 2\%$ of reading for temperature range (>+100°C, >+212°F)
Measurement analysis	
Spotmeter	10
Area	5 boxes with max./min./average
Profile	1 live line (horizontal or vertical)
Difference temperature	Delta temperature between measurement functions or reference temperature
Reference temperature	Manually set or captured from any measurement function
Emissivity correction	Variable from 0.01 to 1.0 or selected from editable materials list
Reflected apparent temperature correction	Automatic, based on input of reflected temperature
Measurement corrections	Reflected temperature, distance, atmospheric transmission, humidity, external optics

Set-up	
Menu commands	Level, span Auto adjust continuous/manual/semi-automatic Zoom Palette Start/stop recording Store image Playback/recall image
Color palettes	Iron, Gray, Rainbow, Arctic, Lava, Rainbow HC
Set-up commands	1 programmable button, overlay recording mode, local adaptation of units, language, date and time formats
Storage of images	
Storage media	Removable SD or SDHC memory card , two card slots
Image storage capacity	> 1200 images (JPEG) with post process capability per GB on memory card
Image storage mode	IR/visual images Visual image can automatically be associated with corresponding IR image
Periodic image storage	Every 10 seconds up to 24 hours
File formats	Standard JPEG, 14 bit measurement data included
Geographic Information System	
GPS	Location data automatically added to every image from built-in GPS
Video recording in camera	
Radiometric IR video recording	*.seq video clips to memory card (7.5 and 15 Hz).
Non-radiometric IR video recording	MPEG4 (up to 60 minutes/clip) to memory card. Visual image can automatically be associated with corresponding recording of non-radiometric IR video.
Visual video recording	MPEG4 (25 minutes/clip) to memory card
Video streaming	
Radiometric IR video streaming	Full dynamic to PC using USB cable or to mobile devices using Wi-Fi. PC software capable of displaying the video stream include the following: <ul style="list-style-type: none"> • FLIR IR Camera Player • FLIR ResearchIR • FLIR Tools
Non-radiometric IR video streaming	RTP/MPEG4
Digital camera	
Built-in digital camera	3.2 Mpixels, auto focus, and two video lamps

Laser pointer	
Laser	Activated by dedicated button
Laser classification	Class 2
Laser type	Semiconductor AlGaInP diode laser, 1 mW, 635 nm (red)
USB	
USB	<ul style="list-style-type: none"> • USB-A: Connect external USB device • USB Mini-B: Data transfer to and from PC
USB, standard	USB Mini-B: 2.0 high speed
Composite video	
Video out	Digital video output (image)
Power system	
Battery type	Rechargeable Li ion battery
Battery voltage	7.2 V
Battery capacity	4.4 Ah
Battery operating time	> 3 hours at 25°C (+77°F) and typical use
Charging system	In camera (AC adapter or 12 V from a vehicle) or 2-bay charger
Charging time	2.5 h to 95% capacity, charging status indicated by LED's
External power operation	AC adapter 90–260 VAC, 50/60 Hz or 12 V from a vehicle (cable with standard plug, optional)
DC operation	10.8 to 16 V DC, polarity protected (proprietary protected)
Power	8.5 W typically
Start-up time	Typically 8 min. @ 25°C (+77°F)
Environmental data	
Operating temperature range	–20°C to +40°C (–4°F to +104°F)
Storage temperature range	–30°C to +60°C (–22°F to +140°F)
Humidity (operating and storage)	IEC 68-2-30/24 h 95% relative humidity +25°C to +40°C (+77°F to +104°F) (2 cycles)
Directives	<ul style="list-style-type: none"> • 73/23EEC • 2004/108/EC • 2002/95/EC • 2002/96/EC
EMC	<ul style="list-style-type: none"> • EN61000-6-4 (Emission) • EN61000-6-2 (Immunity) • FCC 47 CFR Part 15 class A (Emission) • EN 61 000-4-8, L5
Encapsulation	IP 54 (IEC 60529)
Shock	25 g (IEC 60068-2-27)
Vibration	2 g (IEC 60068-2-6)
Safety	Power supply: EN/UL/IEC 60950-1

Physical data	
Camera weight, excl. lens and battery	1.94 kg (4.27 lb.)
Camera weight, incl. lens and excl. battery	2.24 kg (4.94 lb.)
Camera weight, incl. lens and battery	2.48 kg (5.47 lb.)
Battery weight	0.24 kg (0.52 lb.)
Camera size, excl. lens (L × W × H)	284 × 169 × 161 mm (11.2 × 6.7 × 6.3 in.)
Cameras size, incl. lens (L × W × H)	305 × 169 × 161 mm (12.0 × 6.7 × 6.3 in.)
Battery size (L × W × H)	141 × 47 × 28 mm (5.5 × 1.8 × 1.1 in.)
Battery charger size (L × W × H)	158 × 122 × 25 mm (6.2 × 4.8 × 1.0 in.)
Tripod mounting	UNC ¼"-20
Housing material	Aluminum, magnesium
Grip material	TPE thermoplastic elastomers
Shipping information	
Packaging, type	Cardboard box
List of contents	<ul style="list-style-type: none"> • Infrared camera with lens • Battery charger • Battery, 2 ea. • Hard transport case • HDMI-DVI cable • HDMI-HDMI cable • Lens cap (2 ea.) • Lens cap (mounted on lens) • Memory card • Power supply, incl. multi-plugs • Printed documentation • Shoulder strap • USB cable • Wi-Fi USB micro adapter (depending on CE and FCC regulations regarding wireless equipment for your country)
Packaging, weight	
Packaging, size	400 × 190 × 510 mm (15.7 × 7.5 × 20.1 in.)

Supplies & accessories:

- T197386; IR lens, 24° with case for GF304, GF306
- T197384; IR lens, 14.5° with case for GF304, GF306
- T197692; Battery charger, incl. power supply with multi plugs
- T910814; Power supply, incl. multi plugs
- T198511; Li-Ion Battery pack 7.4V 33Wh
- T199367ACC; Battery Li-ion 7.2 V, 4.4 Ah, 32 Wh
- T911650ACC; Memory card SD Card 8 GB
- 1910423; USB cable Std A <-> Mini-B
- T198509; Cigarette lighter adapter kit, 12 VDC, 1.2 m/3.9 ft.
- T910815ACC; HDMI to HDMI cable 1.5 m
- T910816ACC; HDMI to DVI cable 1.5 m
- T197555; Hard transport case for FLIR GF3xx-Series
- T951387; Wi-Fi USB micro adapter
- T198586; FLIR Reporter Professional (license only)
- T198584; FLIR Tools
- T198583; FLIR Tools+ (download card incl. license key)

-
- T198585; FLIR VideoReport
 - DSW-10000; FLIR IR Camera Player
 - APP-10002; FLIR Tools Mobile (Android Application)
 - T198697; FLIR ResearchIR Max + HSDR 4 (hardware sec. dev.)
 - T199014; FLIR ResearchIR Max + HSDR 4 (printed license key)
 - T199044; FLIR ResearchIR Max + HSDR 4 Upgrade (printed license key)
 - T198696; FLIR ResearchIR Max 4 (hardware sec. dev.)
 - T199013; FLIR ResearchIR Max 4 (printed license key)
 - T199043; FLIR ResearchIR Max 4 Upgrade (printed license key)
 - T198731; FLIR ResearchIR Standard 4 (hardware sec. dev.)
 - T199012; FLIR ResearchIR Standard 4 (printed license key)
 - T199042; FLIR ResearchIR Standard 4 Upgrade (printed license key)
 - T199233; FLIR Atlas SDK for .NET
 - T199234; FLIR Atlas SDK for MATLAB
 - T198567; ThermoVision™ System Developers Kit Ver. 2.6
 - T198566; ThermoVision™ LabVIEW® Digital Toolkit Ver. 3.3

22.9 FLIR GF304 14.5° Fixed lens

P/N: 59602-0101

Rev.: 45202

General description	
<p>The FLIR GF304 is an infrared camera for optical gas imaging (OGI) that visualizes and pinpoints leaks of refrigerant gases, without the need to shut down the operation. This portable camera also greatly improves operator safety, by detecting gases at a safe distance, and helps to protect the environment by tracing leaks of environmentally harmful gases.</p> <p>Refrigerant gases are found in, for example, the food, chemical/petrochemical, and automotive industries, as well as in air-conditioning systems.</p>	
Benefits:	
<ul style="list-style-type: none"> • Improved efficiency: The FLIR GF304 reduces revenue loss by pinpointing even small gas leaks quickly and efficiently, and from a distance. It also reduces the inspection time by being able to scan a broad area rapidly without the need to interrupt the industrial process. The wireless connectivity of the camera allows you to connect to smart phones or tablets for the wireless transfer of images or the remote control of the camera. The FLIR GF304 can also be used for temperature measurement, which makes it even more useful for predictive maintenance. • Increased worker safety: The leak detection of gases can be performed in non-contact mode, and from a safe distance. This reduces the risk of the user being exposed to invisible and potentially harmful or explosive chemicals. With a FLIR GF304 gas-imaging camera it is easy to scan areas of interest that are difficult to reach with conventional methods. The camera is ergonomically designed, with a bright LCD and a tiltable viewfinder, which facilitates its use over a full working day. • Protecting the environment: Several refrigerant gases have a high global warming potential and are usually governed by regulations. Even small leaks can be detected and documented using the FLIR GF304 camera. 	
Detects the following refrigerant gases: R404A, R407C, R410A, R134A, R417A, R422A, R507A, R143A, R125, R245fa.	
Imaging and optical data	
IR resolution	320 × 240 pixels
Thermal sensitivity/NETD	<15 mK @ +30°C (+86°F)
Field of view (FOV)	14.5° × 10.8°
Minimum focus distance	0.5 m (1.64 ft.)
Focal length	38 mm (1.49 in.)
Lens identification	Automatic
F-number	1.5
Focus	Automatic (one touch) or manual (electric or on the lens)
Zoom	1–8× continuous, digital zoom
Digital image enhancement	Noise reduction filter, high sensitivity mode (HSM)
Detector data	
Detector type	Focal plane array (FPA), cooled QWIP
Spectral range	8.0–8.6 μm
Detector pitch	30 μm
Sensor cooling	Stirling Microcooler (FLIR MC-3)
Detects following gases	R404A, R407C, R410A, R417A, R422A, R507A, R143A, R125, R134A, R245fa

Electronics and data rate	
Full frame rate	60 Hz
Image presentation	
Display	Built-in widescreen, 4.3 in. LCD, 800 × 480 pixels
Viewfinder	Built-in, tiltable OLED, 800 × 480 pixels
Automatic image adjustment	Continuous/manual; linear or histogram based
Manual image adjustment	Level/span
Image presentation modes	
Image modes	IR image, visual image, high sensitivity mode (HSM)
Measurement	
Temperature range	-20°C to +250°C (-4°F to +482°F)
Accuracy	±1°C (±1.8°F) for temperature range (0°C, to +100°C, +32°F to +212°F) or ±2% of reading for temperature range (>+100°C, >+212°F)
Measurement analysis	
Spotmeter	10
Area	5 boxes with max./min./average
Profile	1 live line (horizontal or vertical)
Difference temperature	Delta temperature between measurement functions or reference temperature
Reference temperature	Manually set or captured from any measurement function
Emissivity correction	Variable from 0.01 to 1.0 or selected from editable materials list
Reflected apparent temperature correction	Automatic, based on input of reflected temperature
Measurement corrections	Reflected temperature, distance, atmospheric transmission, humidity, external optics
Set-up	
Menu commands	Level, span Auto adjust continuous/manual/semi-automatic Zoom Palette Start/stop recording Store image Playback/recall image
Color palettes	Iron, Gray, Rainbow, Arctic, Lava, Rainbow HC
Set-up commands	1 programmable button, overlay recording mode, local adaptation of units, language, date and time formats

Storage of images	
Storage media	Removable SD or SDHC memory card , two card slots
Image storage capacity	> 1200 images (JPEG) with post process capability per GB on memory card
Image storage mode	IR/visual images Visual image can automatically be associated with corresponding IR image
Periodic image storage	Every 10 seconds up to 24 hours
File formats	Standard JPEG, 14 bit measurement data included
Geographic Information System	
GPS	Location data automatically added to every image from built-in GPS
Video recording in camera	
Radiometric IR video recording	*.seq video clips to memory card (7.5 and 15 Hz).
Non-radiometric IR video recording	MPEG4 (up to 60 minutes/clip) to memory card. Visual image can automatically be associated with corresponding recording of non-radiometric IR video.
Visual video recording	MPEG4 (25 minutes/clip) to memory card
Video streaming	
Radiometric IR video streaming	Full dynamic to PC using USB cable or to mobile devices using Wi-Fi. PC software capable of displaying the video stream include the following: <ul style="list-style-type: none"> • FLIR IR Camera Player • FLIR ResearchIR • FLIR Tools
Non-radiometric IR video streaming	RTP/MPEG4
Digital camera	
Built-in digital camera	3.2 Mpixels, auto focus, and two video lamps
Laser pointer	
Laser	Activated by dedicated button
Laser classification	Class 2
Laser type	Semiconductor AlGaInP diode laser, 1 mW, 635 nm (red)
USB	
USB	<ul style="list-style-type: none"> • USB-A: Connect external USB device • USB Mini-B: Data transfer to and from PC
USB, standard	USB Mini-B: 2.0 high speed
Composite video	
Video out	Digital video output (image)

Power system	
Battery type	Rechargeable Li ion battery
Battery voltage	7.2 V
Battery capacity	4.4 Ah
Battery operating time	> 3 hours at 25°C (+77°F) and typical use
Charging system	In camera (AC adapter or 12 V from a vehicle) or 2-bay charger
Charging time	2.5 h to 95% capacity, charging status indicated by LED's
External power operation	AC adapter 90–260 VAC, 50/60 Hz or 12 V from a vehicle (cable with standard plug, optional)
DC operation	10.8 to 16 V DC, polarity protected (proprietary protected)
Power	8.5 W typically
Start-up time	Typically 8 min. @ 25°C (+77°F)
Environmental data	
Operating temperature range	–20°C to +40°C (–4°F to +104°F)
Storage temperature range	–30°C to +60°C (–22°F to +140°F)
Humidity (operating and storage)	IEC 68-2-30/24 h 95% relative humidity +25°C to +40°C (+77°F to +104°F) (2 cycles)
Directives	<ul style="list-style-type: none"> • 73/23EEC • 2004/108/EC • 2002/95/EC • 2002/96/EC
EMC	<ul style="list-style-type: none"> • EN61000-6-4 (Emission) • EN61000-6-2 (Immunity) • FCC 47 CFR Part 15 class A (Emission) • EN 61 000-4-8, L5
Encapsulation	IP 54 (IEC 60529)
Shock	25 g (IEC 60068-2-27)
Vibration	2 g (IEC 60068-2-6)
Safety	Power supply: EN/UL/IEC 60950-1
Physical data	
Camera weight, excl. lens and battery	1.94 kg (4.27 lb.)
Camera weight, incl. lens and excl. battery	2.24 kg (4.94 lb.)
Camera weight, incl. lens and battery	2.48 kg (5.47 lb.)
Battery weight	0.24 kg (0.52 lb.)
Camera size, excl. lens (L × W × H)	284 × 169 × 161 mm (11.2 × 6.7 × 6.3 in.)
Cameras size, incl. lens (L × W × H)	305 × 169 × 161 mm (12.0 × 6.7 × 6.3 in.)
Battery size (L × W × H)	141 × 47 × 28 mm (5.5 × 1.8 × 1.1 in.)
Battery charger size (L × W × H)	158 × 122 × 25 mm (6.2 × 4.8 × 1.0 in.)
Tripod mounting	UNC ¼"-20
Housing material	Aluminum, magnesium
Grip material	TPE thermoplastic elastomers

Shipping information	
Packaging, type	Cardboard box
List of contents	<ul style="list-style-type: none"> • Infrared camera with lens • Battery charger • Battery, 2 ea. • Hard transport case • HDMI-DVI cable • HDMI-HDMI cable • Lens cap (mounted on lens) • Memory card • Power supply, incl. multi-plugs • Printed documentation • Shoulder strap • USB cable • Wi-Fi USB micro adapter (depending on CE and FCC regulations regarding wireless equipment for your country)
Packaging, weight	
Packaging, size	400 × 190 × 510 mm (15.7 × 7.5 × 20.1 in.)

Supplies & accessories:

- T197692; Battery charger, incl. power supply with multi plugs
- T910814; Power supply, incl. multi plugs
- T198511; Li-Ion Battery pack 7.4V 33Wh
- T199367ACC; Battery Li-ion 7.2 V, 4.4 Ah, 32 Wh
- T911650ACC; Memory card SD Card 8 GB
- 1910423; USB cable Std A <-> Mini-B
- T198509; Cigarette lighter adapter kit, 12 VDC, 1.2 m/3.9 ft.
- T910815ACC; HDMI to HDMI cable 1.5 m
- T910816ACC; HDMI to DVI cable 1.5 m
- T197555; Hard transport case for FLIR GF3xx-Series
- T951387; Wi-Fi USB micro adapter
- T198586; FLIR Reporter Professional (license only)
- T198584; FLIR Tools
- T198583; FLIR Tools+ (download card incl. license key)
- T198585; FLIR VideoReport
- DSW-10000; FLIR IR Camera Player
- APP-10002; FLIR Tools Mobile (Android Application)
- T198697; FLIR ResearchIR Max + HSDR 4 (hardware sec. dev.)
- T199014; FLIR ResearchIR Max + HSDR 4 (printed license key)
- T199044; FLIR ResearchIR Max + HSDR 4 Upgrade (printed license key)
- T198696; FLIR ResearchIR Max 4 (hardware sec. dev.)
- T199013; FLIR ResearchIR Max 4 (printed license key)
- T199043; FLIR ResearchIR Max 4 Upgrade (printed license key)
- T198731; FLIR ResearchIR Standard 4 (hardware sec. dev.)
- T199012; FLIR ResearchIR Standard 4 (printed license key)
- T199042; FLIR ResearchIR Standard 4 Upgrade (printed license key)
- T199233; FLIR Atlas SDK for .NET
- T199234; FLIR Atlas SDK for MATLAB
- T198567; ThermoVision™ System Developers Kit Ver. 2.6
- T198566; ThermoVision™ LabVIEW® Digital Toolkit Ver. 3.3

22.10 FLIR GF304 24°

P/N: 59601-0102

Rev.: 45202

General description	
<p>The FLIR GF304 is an infrared camera for optical gas imaging (OGI) that visualizes and pinpoints leaks of refrigerant gases, without the need to shut down the operation. This portable camera also greatly improves operator safety, by detecting gases at a safe distance, and helps to protect the environment by tracing leaks of environmentally harmful gases.</p> <p>Refrigerant gases are found in, for example, the food, chemical/petrochemical, and automotive industries, as well as in air-conditioning systems.</p>	
Benefits:	
<ul style="list-style-type: none"> Improved efficiency: The FLIR GF304 reduces revenue loss by pinpointing even small gas leaks quickly and efficiently, and from a distance. It also reduces the inspection time by being able to scan a broad area rapidly without the need to interrupt the industrial process. The wireless connectivity of the camera allows you to connect to smart phones or tablets for the wireless transfer of images or the remote control of the camera. The FLIR GF304 can also be used for temperature measurement, which makes it even more useful for predictive maintenance. Increased worker safety: The leak detection of gases can be performed in non-contact mode, and from a safe distance. This reduces the risk of the user being exposed to invisible and potentially harmful or explosive chemicals. With a FLIR GF304 gas-imaging camera it is easy to scan areas of interest that are difficult to reach with conventional methods. The camera is ergonomically designed, with a bright LCD and a tiltable viewfinder, which facilitates its use over a full working day. Protecting the environment: Several refrigerant gases have a high global warming potential and are usually governed by regulations. Even small leaks can be detected and documented using the FLIR GF304 camera. 	
<p>Detects the following refrigerant gases: R404A, R407C, R410A, R134A, R417A, R422A, R507A, R143A, R125, R245fa.</p>	
Licensing and classification	
License information	Interchangeable lens version of the FLIR GF3XX series requires US Department of State License and will be subject to limitations on resale, except inside US. Allow a minimum of 90 days after application submittal for approval.
Imaging and optical data	
IR resolution	320 × 240 pixels
Thermal sensitivity/NETD	<15 mK @ +30°C (+86°F)
Field of view (FOV)	24° × 18°
Minimum focus distance	0.3 m (1.0 ft.)
Focal length	23 mm (0.89 in.)
Lens identification	Automatic
F-number	1.5
Focus	Automatic (one touch) or manual (electric or on the lens)
Zoom	1–8x continuous, digital zoom
Digital image enhancement	Noise reduction filter, high sensitivity mode (HSM)

Detector data	
Detector type	Focal plane array (FPA), cooled QWIP
Spectral range	8.0–8.6 μm
Detector pitch	30 μm
Sensor cooling	Stirling Microcooler (FLIR MC-3)
Detects following gases	R404A, R407C, R410A, R417A, R422A, R507A, R143A, R125, R134A, R245fa
Electronics and data rate	
Full frame rate	60 Hz
Image presentation	
Display	Built-in widescreen, 4.3 in. LCD, 800 \times 480 pixels
Viewfinder	Built-in, tiltable OLED, 800 \times 480 pixels
Automatic image adjustment	Continuous/manual; linear or histogram based
Manual image adjustment	Level/span
Image presentation modes	
Image modes	IR image, visual image, high sensitivity mode (HSM)
Measurement	
Temperature range	-20°C to +250°C (-4°F to +482°F)
Accuracy	$\pm 1^\circ\text{C}$ ($\pm 1.8^\circ\text{F}$) for temperature range (0°C, to +100°C, +32°F to +212°F) or $\pm 2\%$ of reading for temperature range (>+100°C, >+212°F)
Measurement analysis	
Spotmeter	10
Area	5 boxes with max./min./average
Profile	1 live line (horizontal or vertical)
Difference temperature	Delta temperature between measurement functions or reference temperature
Reference temperature	Manually set or captured from any measurement function
Emissivity correction	Variable from 0.01 to 1.0 or selected from editable materials list
Reflected apparent temperature correction	Automatic, based on input of reflected temperature
Measurement corrections	Reflected temperature, distance, atmospheric transmission, humidity, external optics

Set-up	
Menu commands	Level, span Auto adjust continuous/manual/semi-automatic Zoom Palette Start/stop recording Store image Playback/recall image
Color palettes	Iron, Gray, Rainbow, Arctic, Lava, Rainbow HC
Set-up commands	1 programmable button, overlay recording mode, local adaptation of units, language, date and time formats
Storage of images	
Storage media	Removable SD or SDHC memory card , two card slots
Image storage capacity	> 1200 images (JPEG) with post process capability per GB on memory card
Image storage mode	IR/visual images Visual image can automatically be associated with corresponding IR image
Periodic image storage	Every 10 seconds up to 24 hours
File formats	Standard JPEG, 14 bit measurement data included
Geographic Information System	
GPS	Location data automatically added to every image from built-in GPS
Video recording in camera	
Radiometric IR video recording	*.seq video clips to memory card (7.5 and 15 Hz).
Non-radiometric IR video recording	MPEG4 (up to 60 minutes/clip) to memory card. Visual image can automatically be associated with corresponding recording of non-radiometric IR video.
Visual video recording	MPEG4 (25 minutes/clip) to memory card
Video streaming	
Radiometric IR video streaming	Full dynamic to PC using USB cable or to mobile devices using Wi-Fi. PC software capable of displaying the video stream include the following: <ul style="list-style-type: none"> • FLIR IR Camera Player • FLIR ResearchIR • FLIR Tools
Non-radiometric IR video streaming	RTP/MPEG4
Digital camera	
Built-in digital camera	3.2 Mpixels, auto focus, and two video lamps

Laser pointer	
Laser	Activated by dedicated button
Laser classification	Class 2
Laser type	Semiconductor AlGaInP diode laser, 1 mW, 635 nm (red)
USB	
USB	<ul style="list-style-type: none"> • USB-A: Connect external USB device • USB Mini-B: Data transfer to and from PC
USB, standard	USB Mini-B: 2.0 high speed
Composite video	
Video out	Digital video output (image)
Power system	
Battery type	Rechargeable Li ion battery
Battery voltage	7.2 V
Battery capacity	4.4 Ah
Battery operating time	> 3 hours at 25°C (+77°F) and typical use
Charging system	In camera (AC adapter or 12 V from a vehicle) or 2-bay charger
Charging time	2.5 h to 95% capacity, charging status indicated by LED's
External power operation	AC adapter 90–260 VAC, 50/60 Hz or 12 V from a vehicle (cable with standard plug, optional)
DC operation	10.8 to 16 V DC, polarity protected (proprietary protected)
Power	8.5 W typically
Start-up time	Typically 8 min. @ 25°C (+77°F)
Environmental data	
Operating temperature range	–20°C to +40°C (–4°F to +104°F)
Storage temperature range	–30°C to +60°C (–22°F to +140°F)
Humidity (operating and storage)	IEC 68-2-30/24 h 95% relative humidity +25°C to +40°C (+77°F to +104°F) (2 cycles)
Directives	<ul style="list-style-type: none"> • 73/23EEC • 2004/108/EC • 2002/95/EC • 2002/96/EC
EMC	<ul style="list-style-type: none"> • EN61000-6-4 (Emission) • EN61000-6-2 (Immunity) • FCC 47 CFR Part 15 class A (Emission) • EN 61 000-4-8, L5
Encapsulation	IP 54 (IEC 60529)
Shock	25 g (IEC 60068-2-27)
Vibration	2 g (IEC 60068-2-6)
Safety	Power supply: EN/UL/IEC 60950-1

Physical data	
Camera weight, excl. lens and battery	1.94 kg (4.27 lb.)
Camera weight, incl. lens and excl. battery	2.24 kg (4.94 lb.)
Camera weight, incl. lens and battery	2.48 kg (5.47 lb.)
Battery weight	0.24 kg (0.52 lb.)
Camera size, excl. lens (L × W × H)	284 × 169 × 161 mm (11.2 × 6.7 × 6.3 in.)
Cameras size, incl. lens (L × W × H)	306 × 169 × 161 mm (12.0 × 6.7 × 6.3 in.)
Battery size (L × W × H)	141 × 47 × 28 mm (5.5 × 1.8 × 1.1 in.)
Battery charger size (L × W × H)	158 × 122 × 25 mm (6.2 × 4.8 × 1.0 in.)
Tripod mounting	UNC ¼"-20
Housing material	Aluminum, magnesium
Grip material	TPE thermoplastic elastomers
Shipping information	
Packaging, type	Cardboard box
List of contents	<ul style="list-style-type: none"> • Infrared camera with lens • Battery charger • Battery, 2 ea. • Hard transport case • HDMI-DVI cable • HDMI-HDMI cable • Lens cap (2 ea.) • Lens cap (mounted on lens) • Memory card • Power supply, incl. multi-plugs • Printed documentation • Shoulder strap • USB cable • Wi-Fi USB micro adapter (depending on CE and FCC regulations regarding wireless equipment for your country)
Packaging, weight	
Packaging, size	400 × 190 × 510 mm (15.7 × 7.5 × 20.1 in.)

Supplies & accessories:

- T197386; IR lens, 24° with case for GF304, GF306
- T197384; IR lens, 14.5° with case for GF304, GF306
- T197692; Battery charger, incl. power supply with multi plugs
- T910814; Power supply, incl. multi plugs
- T198511; Li-Ion Battery pack 7.4V 33Wh
- T199367ACC; Battery Li-ion 7.2 V, 4.4 Ah, 32 Wh
- T911650ACC; Memory card SD Card 8 GB
- 1910423; USB cable Std A <-> Mini-B
- T198509; Cigarette lighter adapter kit, 12 VDC, 1.2 m/3.9 ft.
- T910815ACC; HDMI to HDMI cable 1.5 m
- T910816ACC; HDMI to DVI cable 1.5 m
- T197555; Hard transport case for FLIR GF3xx-Series
- T951387; Wi-Fi USB micro adapter
- T198586; FLIR Reporter Professional (license only)
- T198584; FLIR Tools
- T198583; FLIR Tools+ (download card incl. license key)

- T198585; FLIR VideoReport
- DSW-10000; FLIR IR Camera Player
- APP-10002; FLIR Tools Mobile (Android Application)
- T198697; FLIR ResearchIR Max + HSDR 4 (hardware sec. dev.)
- T199014; FLIR ResearchIR Max + HSDR 4 (printed license key)
- T199044; FLIR ResearchIR Max + HSDR 4 Upgrade (printed license key)
- T198696; FLIR ResearchIR Max 4 (hardware sec. dev.)
- T199013; FLIR ResearchIR Max 4 (printed license key)
- T199043; FLIR ResearchIR Max 4 Upgrade (printed license key)
- T198731; FLIR ResearchIR Standard 4 (hardware sec. dev.)
- T199012; FLIR ResearchIR Standard 4 (printed license key)
- T199042; FLIR ResearchIR Standard 4 Upgrade (printed license key)
- T199233; FLIR Atlas SDK for .NET
- T199234; FLIR Atlas SDK for MATLAB
- T198567; ThermoVision™ System Developers Kit Ver. 2.6
- T198566; ThermoVision™ LabVIEW® Digital Toolkit Ver. 3.3

22.11 FLIR GF304 24° Fixed lens

P/N: 59602-0102

Rev.: 45202

General description	
<p>The FLIR GF304 is an infrared camera for optical gas imaging (OGI) that visualizes and pinpoints leaks of refrigerant gases, without the need to shut down the operation. This portable camera also greatly improves operator safety, by detecting gases at a safe distance, and helps to protect the environment by tracing leaks of environmentally harmful gases.</p> <p>Refrigerant gases are found in, for example, the food, chemical/petrochemical, and automotive industries, as well as in air-conditioning systems.</p>	
Benefits:	
<ul style="list-style-type: none"> • Improved efficiency: The FLIR GF304 reduces revenue loss by pinpointing even small gas leaks quickly and efficiently, and from a distance. It also reduces the inspection time by being able to scan a broad area rapidly without the need to interrupt the industrial process. The wireless connectivity of the camera allows you to connect to smart phones or tablets for the wireless transfer of images or the remote control of the camera. The FLIR GF304 can also be used for temperature measurement, which makes it even more useful for predictive maintenance. • Increased worker safety: The leak detection of gases can be performed in non-contact mode, and from a safe distance. This reduces the risk of the user being exposed to invisible and potentially harmful or explosive chemicals. With a FLIR GF304 gas-imaging camera it is easy to scan areas of interest that are difficult to reach with conventional methods. The camera is ergonomically designed, with a bright LCD and a tiltable viewfinder, which facilitates its use over a full working day. • Protecting the environment: Several refrigerant gases have a high global warming potential and are usually governed by regulations. Even small leaks can be detected and documented using the FLIR GF304 camera. 	
Detects the following refrigerant gases: R404A, R407C, R410A, R134A, R417A, R422A, R507A, R143A, R125, R245fa.	
Imaging and optical data	
IR resolution	320 × 240 pixels
Thermal sensitivity/NETD	<15 mK @ +30°C (+86°F)
Field of view (FOV)	24° × 18°
Minimum focus distance	0.3 m (1.0 ft.)
Focal length	23 mm (0.89 in.)
Lens identification	Automatic
F-number	1.5
Focus	Automatic (one touch) or manual (electric or on the lens)
Zoom	1–8× continuous, digital zoom
Digital image enhancement	Noise reduction filter, high sensitivity mode (HSM)
Detector data	
Detector type	Focal plane array (FPA), cooled QWIP
Spectral range	8.0–8.6 μm
Detector pitch	30 μm
Sensor cooling	Stirling Microcooler (FLIR MC-3)
Detects following gases	R404A, R407C, R410A, R417A, R422A, R507A, R143A, R125, R134A, R245fa

Electronics and data rate	
Full frame rate	60 Hz
Image presentation	
Display	Built-in widescreen, 4.3 in. LCD, 800 × 480 pixels
Viewfinder	Built-in, tiltable OLED, 800 × 480 pixels
Automatic image adjustment	Continuous/manual; linear or histogram based
Manual image adjustment	Level/span
Image presentation modes	
Image modes	IR image, visual image, high sensitivity mode (HSM)
Measurement	
Temperature range	-20°C to +250°C (-4°F to +482°F)
Accuracy	±1°C (±1.8°F) for temperature range (0°C, to +100°C, +32°F to +212°F) or ±2% of reading for temperature range (>+100°C, >+212°F)
Measurement analysis	
Spotmeter	10
Area	5 boxes with max./min./average
Profile	1 live line (horizontal or vertical)
Difference temperature	Delta temperature between measurement functions or reference temperature
Reference temperature	Manually set or captured from any measurement function
Emissivity correction	Variable from 0.01 to 1.0 or selected from editable materials list
Reflected apparent temperature correction	Automatic, based on input of reflected temperature
Measurement corrections	Reflected temperature, distance, atmospheric transmission, humidity, external optics
Set-up	
Menu commands	Level, span Auto adjust continuous/manual/semi-automatic Zoom Palette Start/stop recording Store image Playback/recall image
Color palettes	Iron, Gray, Rainbow, Arctic, Lava, Rainbow HC
Set-up commands	1 programmable button, overlay recording mode, local adaptation of units, language, date and time formats

Storage of images	
Storage media	Removable SD or SDHC memory card , two card slots
Image storage capacity	> 1200 images (JPEG) with post process capability per GB on memory card
Image storage mode	IR/visual images Visual image can automatically be associated with corresponding IR image
Periodic image storage	Every 10 seconds up to 24 hours
File formats	Standard JPEG, 14 bit measurement data included
Geographic Information System	
GPS	Location data automatically added to every image from built-in GPS
Video recording in camera	
Radiometric IR video recording	*.seq video clips to memory card (7.5 and 15 Hz).
Non-radiometric IR video recording	MPEG4 (up to 60 minutes/clip) to memory card. Visual image can automatically be associated with corresponding recording of non-radiometric IR video.
Visual video recording	MPEG4 (25 minutes/clip) to memory card
Video streaming	
Radiometric IR video streaming	Full dynamic to PC using USB cable or to mobile devices using Wi-Fi. PC software capable of displaying the video stream include the following: <ul style="list-style-type: none"> • FLIR IR Camera Player • FLIR ResearchIR • FLIR Tools
Non-radiometric IR video streaming	RTP/MPEG4
Digital camera	
Built-in digital camera	3.2 Mpixels, auto focus, and two video lamps
Laser pointer	
Laser	Activated by dedicated button
Laser classification	Class 2
Laser type	Semiconductor AlGaInP diode laser, 1 mW, 635 nm (red)
USB	
USB	<ul style="list-style-type: none"> • USB-A: Connect external USB device • USB Mini-B: Data transfer to and from PC
USB, standard	USB Mini-B: 2.0 high speed
Composite video	
Video out	Digital video output (image)

Power system	
Battery type	Rechargeable Li ion battery
Battery voltage	7.2 V
Battery capacity	4.4 Ah
Battery operating time	> 3 hours at 25°C (+77°F) and typical use
Charging system	In camera (AC adapter or 12 V from a vehicle) or 2-bay charger
Charging time	2.5 h to 95% capacity, charging status indicated by LED's
External power operation	AC adapter 90–260 VAC, 50/60 Hz or 12 V from a vehicle (cable with standard plug, optional)
DC operation	10.8 to 16 V DC, polarity protected (proprietary protected)
Power	8.5 W typically
Start-up time	Typically 8 min. @ 25°C (+77°F)
Environmental data	
Operating temperature range	–20°C to +40°C (–4°F to +104°F)
Storage temperature range	–30°C to +60°C (–22°F to +140°F)
Humidity (operating and storage)	IEC 68-2-30/24 h 95% relative humidity +25°C to +40°C (+77°F to +104°F) (2 cycles)
Directives	<ul style="list-style-type: none"> • 73/23EEC • 2004/108/EC • 2002/95/EC • 2002/96/EC
EMC	<ul style="list-style-type: none"> • EN61000-6-4 (Emission) • EN61000-6-2 (Immunity) • FCC 47 CFR Part 15 class A (Emission) • EN 61 000-4-8, L5
Encapsulation	IP 54 (IEC 60529)
Shock	25 g (IEC 60068-2-27)
Vibration	2 g (IEC 60068-2-6)
Safety	Power supply: EN/UL/IEC 60950-1
Physical data	
Camera weight, excl. lens and battery	1.94 kg (4.27 lb.)
Camera weight, incl. lens and excl. battery	2.24 kg (4.94 lb.)
Camera weight, incl. lens and battery	2.48 kg (5.47 lb.)
Battery weight	0.24 kg (0.52 lb.)
Camera size, excl. lens (L × W × H)	284 × 169 × 161 mm (11.2 × 6.7 × 6.3 in.)
Cameras size, incl. lens (L × W × H)	306 × 169 × 161 mm (12.0 × 6.7 × 6.3 in.)
Battery size (L × W × H)	141 × 47 × 28 mm (5.5 × 1.8 × 1.1 in.)
Battery charger size (L × W × H)	158 × 122 × 25 mm (6.2 × 4.8 × 1.0 in.)
Tripod mounting	UNC ¼"-20
Housing material	Aluminum, magnesium
Grip material	TPE thermoplastic elastomers

Shipping information	
Packaging, type	Cardboard box
List of contents	<ul style="list-style-type: none"> • Infrared camera with lens • Battery charger • Battery, 2 ea. • Hard transport case • HDMI-DVI cable • HDMI-HDMI cable • Lens cap (mounted on lens) • Memory card • Power supply, incl. multi-plugs • Printed documentation • Shoulder strap • USB cable • Wi-Fi USB micro adapter (depending on CE and FCC regulations regarding wireless equipment for your country)
Packaging, weight	
Packaging, size	400 × 190 × 510 mm (15.7 × 7.5 × 20.1 in.)

Supplies & accessories:

- T197692; Battery charger, incl. power supply with multi plugs
- T910814; Power supply, incl. multi plugs
- T198511; Li-Ion Battery pack 7.4V 33Wh
- T199367ACC; Battery Li-ion 7.2 V, 4.4 Ah, 32 Wh
- T911650ACC; Memory card SD Card 8 GB
- 1910423; USB cable Std A <-> Mini-B
- T198509; Cigarette lighter adapter kit, 12 VDC, 1.2 m/3.9 ft.
- T910815ACC; HDMI to HDMI cable 1.5 m
- T910816ACC; HDMI to DVI cable 1.5 m
- T197555; Hard transport case for FLIR GF3xx-Series
- T951387; Wi-Fi USB micro adapter
- T198586; FLIR Reporter Professional (license only)
- T198584; FLIR Tools
- T198583; FLIR Tools+ (download card incl. license key)
- T198585; FLIR VideoReport
- DSW-10000; FLIR IR Camera Player
- APP-10002; FLIR Tools Mobile (Android Application)
- T198697; FLIR ResearchIR Max + HSDR 4 (hardware sec. dev.)
- T199014; FLIR ResearchIR Max + HSDR 4 (printed license key)
- T199044; FLIR ResearchIR Max + HSDR 4 Upgrade (printed license key)
- T198696; FLIR ResearchIR Max 4 (hardware sec. dev.)
- T199013; FLIR ResearchIR Max 4 (printed license key)
- T199043; FLIR ResearchIR Max 4 Upgrade (printed license key)
- T198731; FLIR ResearchIR Standard 4 (hardware sec. dev.)
- T199012; FLIR ResearchIR Standard 4 (printed license key)
- T199042; FLIR ResearchIR Standard 4 Upgrade (printed license key)
- T199233; FLIR Atlas SDK for .NET
- T199234; FLIR Atlas SDK for MATLAB
- T198567; ThermoVision™ System Developers Kit Ver. 2.6
- T198566; ThermoVision™ LabVIEW® Digital Toolkit Ver. 3.3

22.12 FLIR GF306 14.5°

P/N: 44201-0101

Rev.: 45202

General description	
<p>The FLIR GF306 is an infrared camera for optical gas imaging (OGI) that visualizes and pinpoints gas leaks—especially of sulfur hexafluoride (SF₆) and ammonia—without the need to de-energize high-voltage equipment or shut down the operation. The portable camera also greatly improves operator safety by detecting emissions at a safe distance, and helps to protect the environment by tracing leaks of environmentally harmful gases.</p> <p>SF₆ is used in the electric power industry as an insulator and quenching medium for gas-insulated substations and circuit breakers. The gas is also used in magnesium production and semiconductor manufacture. Ammonia is produced in ammonia plants, and is used mainly for the production of fertilizers.</p>	
Benefits:	
<ul style="list-style-type: none"> Improved efficiency: The FLIR GF306 reduces revenue loss by pinpointing even small gas leaks quickly and efficiently, and from a distance. It also reduces inspection time by allowing a broad area to be scanned rapidly and without the need to de-energize components in the high-voltage area. The wireless connectivity of the camera allows you to connect to smart phones or tablets for the wireless transfer of images or the remote control of the camera. The FLIR GF306 can also be used for temperature measurement, which makes it even more useful for the predictive maintenance of high-voltage equipment. Increased worker safety: OGI allows gas leaks to be detected in a non-contact mode and from a safe distance. This prevents electrical exposure to personnel working in a high-voltage area. With a GF306 gas imaging camera, it is easy to scan areas of interest that are difficult to reach with conventional methods. The camera is ergonomically designed, with a bright LCD and tiltable viewfinder, which facilitates its use over a full working day. Protecting the environment: SF₆ is a well-known greenhouse gas that causes harm to the environment, and is usually governed by regulations. SF₆ has a global warming potential 24 000 times higher than carbon dioxide. Even small leaks can be detected and documented using the FLIR GF306 camera. 	
<p>Detects the following gases: sulfur hexafluoride, acetyl chloride, acetic acid, allyl bromide, allyl chloride, allyl fluoride, ammonia, bromomethane, chlorine dioxide, ethyl cyanoacrylate, ethylene, furan, hydrazine, methylsilane, methyl ethyl ketone, methyl vinyl ketone, propenal, propene, R-134a, tetrahydrofuran, trichloroethylene, uranyl fluoride, vinyl chloride, vinyl cyanide, vinyl ether.</p>	
Licensing and classification	
License information	Interchangeable lens version of the FLIR GF3XX series requires US Department of State License and will be subject to limitations on resale, except inside US. Allow a minimum of 90 days after application submittal for approval.
Imaging and optical data	
IR resolution	320 × 240 pixels
Thermal sensitivity/NETD	<15 mK @ +30°C (+86°F)
Field of view (FOV)	14.5° × 10.8°
Minimum focus distance	0.5 m (1.64 ft.)
Focal length	38 mm (1.49 in.)
Lens identification	Automatic
F-number	1.5
Focus	Automatic (one touch) or manual (electric or on the lens)

Imaging and optical data	
Zoom	1–8× continuous, digital zoom
Digital image enhancement	Noise reduction filter, high sensitivity mode (HSM)
Detector data	
Detector type	Focal plane array (FPA), cooled QWIP
Spectral range	10.3–10.7 μm
Detector pitch	30 μm
Sensor cooling	Stirling Microcooler (FLIR MC-3)
Detects following gases	Sulfur Hexafluoride (SF6), Acetyl Chloride, Acetic Acid, Allyl Bromide, Allyl Chloride, Allyl Fluoride, Ammonia (NH3), Bromomethane, Chlorine Dioxide, Ethyl Cyanoacrylate, Ethylene, Furan, Hydrazine, Methylsilane, Methyl Ethyl Ketone, Methyl Vinyl Ketone, Propenal, Propene, R 134a, Tetrahydrofuran, Trichloroethylene, Uranyl Fluoride, Vinyl Chloride, Vinyl Cyanide, Vinyl Ether
Electronics and data rate	
Full frame rate	60 Hz
Image presentation	
Display	Built-in widescreen, 4.3 in. LCD, 800 × 480 pixels
Viewfinder	Built-in, tiltable OLED, 800 × 480 pixels
Automatic image adjustment	Continuous/manual; linear or histogram based
Manual image adjustment	Level/span
Image presentation modes	
Image modes	IR image, visual image, high sensitivity mode (HSM)
Measurement	
Temperature range	–40°C to +500°C (–40°F to +932°F)
Accuracy	±1°C (±1.8°F) for temperature range (0°C, to +100°C, +32°F to +212°F) or ±2% of reading for temperature range (>+100°C, >+212°F)
Measurement analysis	
Spotmeter	10
Area	5 boxes with max./min./average
Profile	1 live line (horizontal or vertical)
Difference temperature	Delta temperature between measurement functions or reference temperature
Reference temperature	Manually set or captured from any measurement function
Emissivity correction	Variable from 0.01 to 1.0 or selected from editable materials list
Reflected apparent temperature correction	Automatic, based on input of reflected temperature
Measurement corrections	Reflected temperature, distance, atmospheric transmission, humidity, external optics

Set-up	
Menu commands	Level, span Auto adjust continuous/manual/semi-automatic Zoom Palette Start/stop recording Store image Playback/recall image
Color palettes	Iron, Gray, Rainbow, Arctic, Lava, Rainbow HC
Set-up commands	1 programmable button, overlay recording mode, local adaptation of units, language, date and time formats
Storage of images	
Storage media	Removable SD or SDHC memory card , two card slots
Image storage capacity	> 1200 images (JPEG) with post process capability per GB on memory card
Image storage mode	IR/visual images Visual image can automatically be associated with corresponding IR image
Periodic image storage	Every 10 seconds up to 24 hours
File formats	Standard JPEG, 14 bit measurement data included
Geographic Information System	
GPS	Location data automatically added to every image from built-in GPS
Video recording in camera	
Radiometric IR video recording	*.seq video clips to memory card (7.5 and 15 Hz).
Non-radiometric IR video recording	MPEG4 (up to 60 minutes/clip) to memory card. Visual image can automatically be associated with corresponding recording of non-radiometric IR video.
Visual video recording	MPEG4 (25 minutes/clip) to memory card
Video streaming	
Radiometric IR video streaming	Full dynamic to PC using USB cable or to mobile devices using Wi-Fi. PC software capable of displaying the video stream include the following: <ul style="list-style-type: none"> • FLIR IR Camera Player • FLIR ResearchIR • FLIR Tools
Non-radiometric IR video streaming	RTP/MPEG4
Digital camera	
Built-in digital camera	3.2 Mpixels, auto focus, and two video lamps

Laser pointer	
Laser	Activated by dedicated button
Laser classification	Class 2
Laser type	Semiconductor AlGaInP diode laser, 1 mW, 635 nm (red)
USB	
USB	<ul style="list-style-type: none"> • USB-A: Connect external USB device • USB Mini-B: Data transfer to and from PC
USB, standard	USB Mini-B: 2.0 high speed
Composite video	
Video out	Digital video output (image)
Power system	
Battery type	Rechargeable Li ion battery
Battery voltage	7.2 V
Battery capacity	4.4 Ah
Battery operating time	> 2 hours at 25°C (+77°F) and typical use
Charging system	In camera (AC adapter or 12 V from a vehicle) or 2-bay charger
Charging time	2.5 h to 95% capacity, charging status indicated by LED's
External power operation	AC adapter 90–260 VAC, 50/60 Hz or 12 V from a vehicle (cable with standard plug, optional)
DC operation	10.8 to 16 V DC, polarity protected (proprietary protected)
Power	12.5 W typically
Start-up time	Typically 10 min. @ 25°C (+77°F)
Environmental data	
Operating temperature range	–20°C to +40°C (–4°F to +104°F)
Storage temperature range	–30°C to +60°C (–22°F to +140°F)
Humidity (operating and storage)	IEC 68-2-30/24 h 95% relative humidity +25°C to +40°C (+77°F to +104°F) (2 cycles)
Directives	<ul style="list-style-type: none"> • 73/23EEC • 2004/108/EC • 2002/95/EC • 2002/96/EC
EMC	<ul style="list-style-type: none"> • EN61000-6-4 (Emission) • EN61000-6-2 (Immunity) • FCC 47 CFR Part 15 class A (Emission) • EN 61 000-4-8, L5
Encapsulation	IP 54 (IEC 60529)
Shock	25 g (IEC 60068-2-27)
Vibration	2 g (IEC 60068-2-6)
Safety	Power supply: EN/UL/IEC 60950-1

Physical data	
Camera weight, excl. lens and battery	1.94 kg (4.27 lb.)
Camera weight, incl. lens and excl. battery	2.24 kg (4.94 lb.)
Camera weight, incl. lens and battery	2.48 kg (5.47 lb.)
Battery weight	0.24 kg (0.52 lb.)
Camera size, excl. lens (L × W × H)	284 × 169 × 161 mm (11.2 × 6.7 × 6.3 in.)
Cameras size, incl. lens (L × W × H)	305 × 169 × 161 mm (12.0 × 6.7 × 6.3 in.)
Battery size (L × W × H)	141 × 47 × 28 mm (5.5 × 1.8 × 1.1 in.)
Battery charger size (L × W × H)	158 × 122 × 25 mm (6.2 × 4.8 × 1.0 in.)
Tripod mounting	UNC ¼"-20
Housing material	Aluminum, magnesium
Grip material	TPE thermoplastic elastomers
Shipping information	
Packaging, type	Cardboard box
List of contents	<ul style="list-style-type: none"> • Infrared camera with lens • Battery charger • Battery, 2 ea. • Hard transport case • HDMI-DVI cable • HDMI-HDMI cable • Lens cap (2 ea.) • Lens cap (mounted on lens) • Memory card • Power supply, incl. multi-plugs • Printed documentation • Shoulder strap • USB cable • Wi-Fi USB micro adapter (depending on CE and FCC regulations regarding wireless equipment for your country)
Packaging, weight	
Packaging, size	400 × 190 × 510 mm (15.7 × 7.5 × 20.1 in.)

Supplies & accessories:

- T197386; IR lens, 24° with case for GF304, GF306
- T197384; IR lens, 14.5° with case for GF304, GF306
- T197692; Battery charger, incl. power supply with multi plugs
- T910814; Power supply, incl. multi plugs
- T198511; Li-Ion Battery pack 7.4V 33Wh
- T199367ACC; Battery Li-ion 7.2 V, 4.4 Ah, 32 Wh
- T911650ACC; Memory card SD Card 8 GB
- 1910423; USB cable Std A <-> Mini-B
- T198509; Cigarette lighter adapter kit, 12 VDC, 1.2 m/3.9 ft.
- T910815ACC; HDMI to HDMI cable 1.5 m
- T910816ACC; HDMI to DVI cable 1.5 m
- T197555; Hard transport case for FLIR GF3xx-Series
- T951387; Wi-Fi USB micro adapter
- T198586; FLIR Reporter Professional (license only)
- T198584; FLIR Tools
- T198583; FLIR Tools+ (download card incl. license key)

-
- T198585; FLIR VideoReport
 - DSW-10000; FLIR IR Camera Player
 - APP-10002; FLIR Tools Mobile (Android Application)
 - T198697; FLIR ResearchIR Max + HSDR 4 (hardware sec. dev.)
 - T199014; FLIR ResearchIR Max + HSDR 4 (printed license key)
 - T199044; FLIR ResearchIR Max + HSDR 4 Upgrade (printed license key)
 - T198696; FLIR ResearchIR Max 4 (hardware sec. dev.)
 - T199013; FLIR ResearchIR Max 4 (printed license key)
 - T199043; FLIR ResearchIR Max 4 Upgrade (printed license key)
 - T198731; FLIR ResearchIR Standard 4 (hardware sec. dev.)
 - T199012; FLIR ResearchIR Standard 4 (printed license key)
 - T199042; FLIR ResearchIR Standard 4 Upgrade (printed license key)
 - T199233; FLIR Atlas SDK for .NET
 - T199234; FLIR Atlas SDK for MATLAB
 - T198567; ThermoVision™ System Developers Kit Ver. 2.6
 - T198566; ThermoVision™ LabVIEW® Digital Toolkit Ver. 3.3

22.13 FLIR GF306 14.5° Fixed lens

P/N: 44202-0101

Rev.: 45202

General description	
<p>The FLIR GF306 is an infrared camera for optical gas imaging (OGI) that visualizes and pinpoints gas leaks—especially of sulfur hexafluoride (SF₆) and ammonia—without the need to de-energize high-voltage equipment or shut down the operation. The portable camera also greatly improves operator safety by detecting emissions at a safe distance, and helps to protect the environment by tracing leaks of environmentally harmful gases.</p> <p>SF₆ is used in the electric power industry as an insulator and quenching medium for gas-insulated substations and circuit breakers. The gas is also used in magnesium production and semiconductor manufacture. Ammonia is produced in ammonia plants, and is used mainly for the production of fertilizers.</p>	
Benefits:	
<ul style="list-style-type: none"> Improved efficiency: The FLIR GF306 reduces revenue loss by pinpointing even small gas leaks quickly and efficiently, and from a distance. It also reduces inspection time by allowing a broad area to be scanned rapidly and without the need to de-energize components in the high-voltage area. The wireless connectivity of the camera allows you to connect to smart phones or tablets for the wireless transfer of images or the remote control of the camera. The FLIR GF306 can also be used for temperature measurement, which makes it even more useful for the predictive maintenance of high-voltage equipment. Increased worker safety: OGI allows gas leaks to be detected in a non-contact mode and from a safe distance. This prevents electrical exposure to personnel working in a high-voltage area. With a GF306 gas imaging camera, it is easy to scan areas of interest that are difficult to reach with conventional methods. The camera is ergonomically designed, with a bright LCD and tiltable viewfinder, which facilitates its use over a full working day. Protecting the environment: SF₆ is a well-known greenhouse gas that causes harm to the environment, and is usually governed by regulations. SF₆ has a global warming potential 24 000 times higher than carbon dioxide. Even small leaks can be detected and documented using the FLIR GF306 camera. 	
<p>Detects the following gases: sulfur hexafluoride, acetyl chloride, acetic acid, allyl bromide, allyl chloride, allyl fluoride, ammonia, bromomethane, chlorine dioxide, ethyl cyanoacrylate, ethylene, furan, hydrazine, methylsilane, methyl ethyl ketone, methyl vinyl ketone, propenal, propene, R-134a, tetrahydrofuran, trichloroethylene, uranyl fluoride, vinyl chloride, vinyl cyanide, vinyl ether.</p>	
Imaging and optical data	
IR resolution	320 × 240 pixels
Thermal sensitivity/NETD	<15 mK @ +30°C (+86°F)
Field of view (FOV)	14.5° × 10.8°
Minimum focus distance	0.5 m (1.64 ft.)
Focal length	38 mm (1.49 in.)
Lens identification	Automatic
F-number	1.5
Focus	Automatic (one touch) or manual (electric or on the lens)
Zoom	1–8× continuous, digital zoom
Digital image enhancement	Noise reduction filter, high sensitivity mode (HSM)
Detector data	
Detector type	Focal plane array (FPA), cooled QWIP
Spectral range	10.3–10.7 μm
Detector pitch	30 μm

Detector data	
Sensor cooling	Stirling Microcooler (FLIR MC-3)
Detects following gases	Sulfur Hexafluoride (SF6), Acetyl Chloride, Acetic Acid, Allyl Bromide, Allyl Chloride, Allyl Fluoride, Ammonia (NH3), Bromomethane, Chlorine Dioxide, Ethyl Cyanoacrylate, Ethylene, Furan, Hydrazine, Methylsilane, Methyl Ethyl Ketone, Methyl Vinyl Ketone, Propenal, Propene, R 134a, Tetrahydrofuran, Trichloroethylene, Uranyl Fluoride, Vinyl Chloride, Vinyl Cyanide, Vinyl Ether
Electronics and data rate	
Full frame rate	60 Hz
Image presentation	
Display	Built-in widescreen, 4.3 in. LCD, 800 × 480 pixels
Viewfinder	Built-in, tiltable OLED, 800 × 480 pixels
Automatic image adjustment	Continuous/manual; linear or histogram based
Manual image adjustment	Level/span
Image presentation modes	
Image modes	IR image, visual image, high sensitivity mode (HSM)
Measurement	
Temperature range	-40°C to +500°C (-40°F to +932°F)
Accuracy	±1°C (±1.8°F) for temperature range (0°C, to +100°C, +32°F to +212°F) or ±2% of reading for temperature range (>+100°C, >+212°F)
Measurement analysis	
Spotmeter	10
Area	5 boxes with max./min./average
Profile	1 live line (horizontal or vertical)
Difference temperature	Delta temperature between measurement functions or reference temperature
Reference temperature	Manually set or captured from any measurement function
Emissivity correction	Variable from 0.01 to 1.0 or selected from editable materials list
Reflected apparent temperature correction	Automatic, based on input of reflected temperature
Measurement corrections	Reflected temperature, distance, atmospheric transmission, humidity, external optics

Set-up	
Menu commands	Level, span Auto adjust continuous/manual/semi-automatic Zoom Palette Start/stop recording Store image Playback/recall image
Color palettes	Iron, Gray, Rainbow, Arctic, Lava, Rainbow HC
Set-up commands	1 programmable button, overlay recording mode, local adaptation of units, language, date and time formats
Storage of images	
Storage media	Removable SD or SDHC memory card , two card slots
Image storage capacity	> 1200 images (JPEG) with post process capability per GB on memory card
Image storage mode	IR/visual images Visual image can automatically be associated with corresponding IR image
Periodic image storage	Every 10 seconds up to 24 hours
File formats	Standard JPEG, 14 bit measurement data included
Geographic Information System	
GPS	Location data automatically added to every image from built-in GPS
Video recording in camera	
Radiometric IR video recording	*.seq video clips to memory card (7.5 and 15 Hz).
Non-radiometric IR video recording	MPEG4 (up to 60 minutes/clip) to memory card. Visual image can automatically be associated with corresponding recording of non-radiometric IR video.
Visual video recording	MPEG4 (25 minutes/clip) to memory card
Video streaming	
Radiometric IR video streaming	Full dynamic to PC using USB cable or to mobile devices using Wi-Fi. PC software capable of displaying the video stream include the following: <ul style="list-style-type: none"> • FLIR IR Camera Player • FLIR ResearchIR • FLIR Tools
Non-radiometric IR video streaming	RTP/MPEG4
Digital camera	
Built-in digital camera	3.2 Mpixels, auto focus, and two video lamps

Laser pointer	
Laser	Activated by dedicated button
Laser classification	Class 2
Laser type	Semiconductor AlGaInP diode laser, 1 mW, 635 nm (red)
USB	
USB	<ul style="list-style-type: none"> • USB-A: Connect external USB device • USB Mini-B: Data transfer to and from PC
USB, standard	USB Mini-B: 2.0 high speed
Composite video	
Video out	Digital video output (image)
Power system	
Battery type	Rechargeable Li ion battery
Battery voltage	7.2 V
Battery capacity	4.4 Ah
Battery operating time	> 2 hours at 25°C (+77°F) and typical use
Charging system	In camera (AC adapter or 12 V from a vehicle) or 2-bay charger
Charging time	2.5 h to 95% capacity, charging status indicated by LED's
External power operation	AC adapter 90–260 VAC, 50/60 Hz or 12 V from a vehicle (cable with standard plug, optional)
DC operation	10.8 to 16 V DC, polarity protected (proprietary protected)
Power	12.5 W typically
Start-up time	Typically 10 min. @ 25°C (+77°F)
Environmental data	
Operating temperature range	–20°C to +40°C (–4°F to +104°F)
Storage temperature range	–30°C to +60°C (–22°F to +140°F)
Humidity (operating and storage)	IEC 68-2-30/24 h 95% relative humidity +25°C to +40°C (+77°F to +104°F) (2 cycles)
Directives	<ul style="list-style-type: none"> • 73/23EEC • 2004/108/EC • 2002/95/EC • 2002/96/EC
EMC	<ul style="list-style-type: none"> • EN61000-6-4 (Emission) • EN61000-6-2 (Immunity) • FCC 47 CFR Part 15 class A (Emission) • EN 61 000-4-8, L5
Encapsulation	IP 54 (IEC 60529)
Shock	25 g (IEC 60068-2-27)
Vibration	2 g (IEC 60068-2-6)
Safety	Power supply: EN/UL/IEC 60950-1

Physical data	
Camera weight, excl. lens and battery	1.94 kg (4.27 lb.)
Camera weight, incl. lens and excl. battery	2.24 kg (4.94 lb.)
Camera weight, incl. lens and battery	2.48 kg (5.47 lb.)
Battery weight	0.24 kg (0.52 lb.)
Camera size, excl. lens (L × W × H)	284 × 169 × 161 mm (11.2 × 6.7 × 6.3 in.)
Cameras size, incl. lens (L × W × H)	305 × 169 × 161 mm (12.0 × 6.7 × 6.3 in.)
Battery size (L × W × H)	141 × 47 × 28 mm (5.5 × 1.8 × 1.1 in.)
Battery charger size (L × W × H)	158 × 122 × 25 mm (6.2 × 4.8 × 1.0 in.)
Tripod mounting	UNC ¼"-20
Housing material	Aluminum, magnesium
Grip material	TPE thermoplastic elastomers
Shipping information	
Packaging, type	Cardboard box
List of contents	<ul style="list-style-type: none"> • Infrared camera with lens • Battery charger • Battery, 2 ea. • FLIR Tools download • Hard transport case • HDMI-DVI cable • HDMI-HDMI cable • Lens cap (mounted on lens) • Memory card • Power supply, incl. multi-plugs • Printed documentation • Shoulder strap • USB cable • Wi-Fi USB micro adapter (depending on CE and FCC regulations regarding wireless equipment for your country)
Packaging, weight	8.4 kg (18.5 lb.)
Packaging, size	400 × 190 × 510 mm (15.7 × 7.5 × 20.1 in.)

Supplies & accessories:

- T197692; Battery charger, incl. power supply with multi plugs
- T910814; Power supply, incl. multi plugs
- T198511; Li-Ion Battery pack 7.4V 33Wh
- T199367ACC; Battery Li-ion 7.2 V, 4.4 Ah, 32 Wh
- T911650ACC; Memory card SD Card 8 GB
- 1910423; USB cable Std A <-> Mini-B
- T198509; Cigarette lighter adapter kit, 12 VDC, 1.2 m/3.9 ft.
- T910815ACC; HDMI to HDMI cable 1.5 m
- T910816ACC; HDMI to DVI cable 1.5 m
- T197555; Hard transport case for FLIR GF3xx-Series
- T951387; Wi-Fi USB micro adapter
- T198586; FLIR Reporter Professional (license only)
- T198584; FLIR Tools
- T198583; FLIR Tools+ (download card incl. license key)
- T198585; FLIR VideoReport
- DSW-10000; FLIR IR Camera Player

- APP-10002; FLIR Tools Mobile (Android Application)
- T198697; FLIR ResearchIR Max + HSDR 4 (hardware sec. dev.)
- T199014; FLIR ResearchIR Max + HSDR 4 (printed license key)
- T199044; FLIR ResearchIR Max + HSDR 4 Upgrade (printed license key)
- T198696; FLIR ResearchIR Max 4 (hardware sec. dev.)
- T199013; FLIR ResearchIR Max 4 (printed license key)
- T199043; FLIR ResearchIR Max 4 Upgrade (printed license key)
- T198731; FLIR ResearchIR Standard 4 (hardware sec. dev.)
- T199012; FLIR ResearchIR Standard 4 (printed license key)
- T199042; FLIR ResearchIR Standard 4 Upgrade (printed license key)
- T199233; FLIR Atlas SDK for .NET
- T199234; FLIR Atlas SDK for MATLAB
- T198567; ThermoVision™ System Developers Kit Ver. 2.6
- T198566; ThermoVision™ LabVIEW® Digital Toolkit Ver. 3.3

22.14 FLIR GF306 24°

P/N: 44201-0102

Rev.: 45202

General description	
<p>The FLIR GF306 is an infrared camera for optical gas imaging (OGI) that visualizes and pinpoints gas leaks—especially of sulfur hexafluoride (SF₆) and ammonia—without the need to de-energize high-voltage equipment or shut down the operation. The portable camera also greatly improves operator safety by detecting emissions at a safe distance, and helps to protect the environment by tracing leaks of environmentally harmful gases.</p> <p>SF₆ is used in the electric power industry as an insulator and quenching medium for gas-insulated substations and circuit breakers. The gas is also used in magnesium production and semiconductor manufacture. Ammonia is produced in ammonia plants, and is used mainly for the production of fertilizers.</p>	
Benefits:	
<ul style="list-style-type: none"> Improved efficiency: The FLIR GF306 reduces revenue loss by pinpointing even small gas leaks quickly and efficiently, and from a distance. It also reduces inspection time by allowing a broad area to be scanned rapidly and without the need to de-energize components in the high-voltage area. The wireless connectivity of the camera allows you to connect to smart phones or tablets for the wireless transfer of images or the remote control of the camera. The FLIR GF306 can also be used for temperature measurement, which makes it even more useful for the predictive maintenance of high-voltage equipment. Increased worker safety: OGI allows gas leaks to be detected in a non-contact mode and from a safe distance. This prevents electrical exposure to personnel working in a high-voltage area. With a GF306 gas imaging camera, it is easy to scan areas of interest that are difficult to reach with conventional methods. The camera is ergonomically designed, with a bright LCD and tiltable viewfinder, which facilitates its use over a full working day. Protecting the environment: SF₆ is a well-known greenhouse gas that causes harm to the environment, and is usually governed by regulations. SF₆ has a global warming potential 24 000 times higher than carbon dioxide. Even small leaks can be detected and documented using the FLIR GF306 camera. 	
<p>Detects the following gases: sulfur hexafluoride, acetyl chloride, acetic acid, allyl bromide, allyl chloride, allyl fluoride, ammonia, bromomethane, chlorine dioxide, ethyl cyanoacrylate, ethylene, furan, hydrazine, methylsilane, methyl ethyl ketone, methyl vinyl ketone, propenal, propene, R-134a, tetrahydrofuran, trichloroethylene, uranyl fluoride, vinyl chloride, vinyl cyanide, vinyl ether.</p>	
Licensing and classification	
License information	Interchangeable lens version of the FLIR GF3XX series requires US Department of State License and will be subject to limitations on resale, except inside US. Allow a minimum of 90 days after application submittal for approval.
Imaging and optical data	
IR resolution	320 × 240 pixels
Thermal sensitivity/NETD	<15 mK @ +30°C (+86°F)
Field of view (FOV)	24° × 18°
Minimum focus distance	0.3 m (1.0 ft.)
Focal length	23 mm (0.89 in.)
Lens identification	Automatic
F-number	1.5
Focus	Automatic (one touch) or manual (electric or on the lens)

Imaging and optical data	
Zoom	1–8× continuous, digital zoom
Digital image enhancement	Noise reduction filter, high sensitivity mode (HSM)
Detector data	
Detector type	Focal plane array (FPA), cooled QWIP
Spectral range	10.3–10.7 μm
Detector pitch	30 μm
Sensor cooling	Stirling Microcooler (FLIR MC-3)
Detects following gases	Sulfur Hexafluoride (SF ₆), Acetyl Chloride, Acetic Acid, Allyl Bromide, Allyl Chloride, Allyl Fluoride, Ammonia (NH ₃), Bromomethane, Chlorine Dioxide, Ethyl Cyanoacrylate, Ethylene, Furan, Hydrazine, Methylsilane, Methyl Ethyl Ketone, Methyl Vinyl Ketone, Propenal, Propene, R 134a, Tetrahydrofuran, Trichloroethylene, Uranyl Fluoride, Vinyl Chloride, Vinyl Cyanide, Vinyl Ether
Electronics and data rate	
Full frame rate	60 Hz
Image presentation	
Display	Built-in widescreen, 4.3 in. LCD, 800 × 480 pixels
Viewfinder	Built-in, tiltable OLED, 800 × 480 pixels
Automatic image adjustment	Continuous/manual; linear or histogram based
Manual image adjustment	Level/span
Image presentation modes	
Image modes	IR image, visual image, high sensitivity mode (HSM)
Measurement	
Temperature range	–40°C to +500°C (–40°F to +932°F)
Accuracy	±1°C (±1.8°F) for temperature range (0°C, to +100°C, +32°F to +212°F) or ±2% of reading for temperature range (>+100°C, >+212°F)
Measurement analysis	
Spotmeter	10
Area	5 boxes with max./min./average
Profile	1 live line (horizontal or vertical)
Difference temperature	Delta temperature between measurement functions or reference temperature
Reference temperature	Manually set or captured from any measurement function
Emissivity correction	Variable from 0.01 to 1.0 or selected from editable materials list
Reflected apparent temperature correction	Automatic, based on input of reflected temperature
Measurement corrections	Reflected temperature, distance, atmospheric transmission, humidity, external optics

Set-up	
Menu commands	Level, span Auto adjust continuous/manual/semi-automatic Zoom Palette Start/stop recording Store image Playback/recall image
Color palettes	Iron, Gray, Rainbow, Arctic, Lava, Rainbow HC
Set-up commands	1 programmable button, overlay recording mode, local adaptation of units, language, date and time formats
Storage of images	
Storage media	Removable SD or SDHC memory card , two card slots
Image storage capacity	> 1200 images (JPEG) with post process capability per GB on memory card
Image storage mode	IR/visual images Visual image can automatically be associated with corresponding IR image
Periodic image storage	Every 10 seconds up to 24 hours
File formats	Standard JPEG, 14 bit measurement data included
Geographic Information System	
GPS	Location data automatically added to every image from built-in GPS
Video recording in camera	
Radiometric IR video recording	*.seq video clips to memory card (7.5 and 15 Hz).
Non-radiometric IR video recording	MPEG4 (up to 60 minutes/clip) to memory card. Visual image can automatically be associated with corresponding recording of non-radiometric IR video.
Visual video recording	MPEG4 (25 minutes/clip) to memory card
Video streaming	
Radiometric IR video streaming	Full dynamic to PC using USB cable or to mobile devices using Wi-Fi. PC software capable of displaying the video stream include the following: <ul style="list-style-type: none"> • FLIR IR Camera Player • FLIR ResearchIR • FLIR Tools
Non-radiometric IR video streaming	RTP/MPEG4
Digital camera	
Built-in digital camera	3.2 Mpixels, auto focus, and two video lamps

Laser pointer	
Laser	Activated by dedicated button
Laser classification	Class 2
Laser type	Semiconductor AlGaInP diode laser, 1 mW, 635 nm (red)
USB	
USB	<ul style="list-style-type: none"> • USB-A: Connect external USB device • USB Mini-B: Data transfer to and from PC
USB, standard	USB Mini-B: 2.0 high speed
Composite video	
Video out	Digital video output (image)
Power system	
Battery type	Rechargeable Li ion battery
Battery voltage	7.2 V
Battery capacity	4.4 Ah
Battery operating time	> 2 hours at 25°C (+77°F) and typical use
Charging system	In camera (AC adapter or 12 V from a vehicle) or 2-bay charger
Charging time	2.5 h to 95% capacity, charging status indicated by LED's
External power operation	AC adapter 90–260 VAC, 50/60 Hz or 12 V from a vehicle (cable with standard plug, optional)
DC operation	10.8 to 16 V DC, polarity protected (proprietary protected)
Power	12.5 W typically
Start-up time	Typically 10 min. @ 25°C (+77°F)
Environmental data	
Operating temperature range	–20°C to +40°C (–4°F to +104°F)
Storage temperature range	–30°C to +60°C (–22°F to +140°F)
Humidity (operating and storage)	IEC 68-2-30/24 h 95% relative humidity +25°C to +40°C (+77°F to +104°F) (2 cycles)
Directives	<ul style="list-style-type: none"> • 73/23EEC • 2004/108/EC • 2002/95/EC • 2002/96/EC
EMC	<ul style="list-style-type: none"> • EN61000-6-4 (Emission) • EN61000-6-2 (Immunity) • FCC 47 CFR Part 15 class A (Emission) • EN 61 000-4-8, L5
Encapsulation	IP 54 (IEC 60529)
Shock	25 g (IEC 60068-2-27)
Vibration	2 g (IEC 60068-2-6)
Safety	Power supply: EN/UL/IEC 60950-1

Physical data	
Camera weight, excl. lens and battery	1.94 kg (4.27 lb.)
Camera weight, incl. lens and excl. battery	2.24 kg (4.94 lb.)
Camera weight, incl. lens and battery	2.48 kg (5.47 lb.)
Battery weight	0.24 kg (0.52 lb.)
Camera size, excl. lens (L × W × H)	284 × 169 × 161 mm (11.2 × 6.7 × 6.3 in.)
Cameras size, incl. lens (L × W × H)	306 × 169 × 161 mm (12.0 × 6.7 × 6.3 in.)
Battery size (L × W × H)	141 × 47 × 28 mm (5.5 × 1.8 × 1.1 in.)
Battery charger size (L × W × H)	158 × 122 × 25 mm (6.2 × 4.8 × 1.0 in.)
Tripod mounting	UNC ¼"-20
Housing material	Aluminum, magnesium
Grip material	TPE thermoplastic elastomers
Shipping information	
Packaging, type	Cardboard box
List of contents	<ul style="list-style-type: none"> • Infrared camera with lens • Battery charger • Battery, 2 ea. • Hard transport case • HDMI-DVI cable • HDMI-HDMI cable • Lens cap (2 ea.) • Lens cap (mounted on lens) • Memory card • Power supply, incl. multi-plugs • Printed documentation • Shoulder strap • USB cable • Wi-Fi USB micro adapter (depending on CE and FCC regulations regarding wireless equipment for your country)
Packaging, weight	
Packaging, size	400 × 190 × 510 mm (15.7 × 7.5 × 20.1 in.)

Supplies & accessories:

- T197386; IR lens, 24° with case for GF304, GF306
- T197384; IR lens, 14.5° with case for GF304, GF306
- T197692; Battery charger, incl. power supply with multi plugs
- T910814; Power supply, incl. multi plugs
- T198511; Li-Ion Battery pack 7.4V 33Wh
- T199367ACC; Battery Li-ion 7.2 V, 4.4 Ah, 32 Wh
- T911650ACC; Memory card SD Card 8 GB
- 1910423; USB cable Std A <-> Mini-B
- T198509; Cigarette lighter adapter kit, 12 VDC, 1.2 m/3.9 ft.
- T910815ACC; HDMI to HDMI cable 1.5 m
- T910816ACC; HDMI to DVI cable 1.5 m
- T197555; Hard transport case for FLIR GF3xx-Series
- T951387; Wi-Fi USB micro adapter
- T198586; FLIR Reporter Professional (license only)
- T198584; FLIR Tools
- T198583; FLIR Tools+ (download card incl. license key)

- T198585; FLIR VideoReport
- DSW-10000; FLIR IR Camera Player
- APP-10002; FLIR Tools Mobile (Android Application)
- T198697; FLIR ResearchIR Max + HSDR 4 (hardware sec. dev.)
- T199014; FLIR ResearchIR Max + HSDR 4 (printed license key)
- T199044; FLIR ResearchIR Max + HSDR 4 Upgrade (printed license key)
- T198696; FLIR ResearchIR Max 4 (hardware sec. dev.)
- T199013; FLIR ResearchIR Max 4 (printed license key)
- T199043; FLIR ResearchIR Max 4 Upgrade (printed license key)
- T198731; FLIR ResearchIR Standard 4 (hardware sec. dev.)
- T199012; FLIR ResearchIR Standard 4 (printed license key)
- T199042; FLIR ResearchIR Standard 4 Upgrade (printed license key)
- T199233; FLIR Atlas SDK for .NET
- T199234; FLIR Atlas SDK for MATLAB
- T198567; ThermoVision™ System Developers Kit Ver. 2.6
- T198566; ThermoVision™ LabVIEW® Digital Toolkit Ver. 3.3

22.15 FLIR GF306 24° Fixed lens

P/N: 44202-0102

Rev.: 45202

General description	
<p>The FLIR GF306 is an infrared camera for optical gas imaging (OGI) that visualizes and pinpoints gas leaks—especially of sulfur hexafluoride (SF₆) and ammonia—without the need to de-energize high-voltage equipment or shut down the operation. The portable camera also greatly improves operator safety by detecting emissions at a safe distance, and helps to protect the environment by tracing leaks of environmentally harmful gases.</p> <p>SF₆ is used in the electric power industry as an insulator and quenching medium for gas-insulated substations and circuit breakers. The gas is also used in magnesium production and semiconductor manufacture. Ammonia is produced in ammonia plants, and is used mainly for the production of fertilizers.</p>	
Benefits:	
<ul style="list-style-type: none"> Improved efficiency: The FLIR GF306 reduces revenue loss by pinpointing even small gas leaks quickly and efficiently, and from a distance. It also reduces inspection time by allowing a broad area to be scanned rapidly and without the need to de-energize components in the high-voltage area. The wireless connectivity of the camera allows you to connect to smart phones or tablets for the wireless transfer of images or the remote control of the camera. The FLIR GF306 can also be used for temperature measurement, which makes it even more useful for the predictive maintenance of high-voltage equipment. Increased worker safety: OGI allows gas leaks to be detected in a non-contact mode and from a safe distance. This prevents electrical exposure to personnel working in a high-voltage area. With a GF306 gas imaging camera, it is easy to scan areas of interest that are difficult to reach with conventional methods. The camera is ergonomically designed, with a bright LCD and tiltable viewfinder, which facilitates its use over a full working day. Protecting the environment: SF₆ is a well-known greenhouse gas that causes harm to the environment, and is usually governed by regulations. SF₆ has a global warming potential 24 000 times higher than carbon dioxide. Even small leaks can be detected and documented using the FLIR GF306 camera. 	
<p>Detects the following gases: sulfur hexafluoride, acetyl chloride, acetic acid, allyl bromide, allyl chloride, allyl fluoride, ammonia, bromomethane, chlorine dioxide, ethyl cyanoacrylate, ethylene, furan, hydrazine, methylsilane, methyl ethyl ketone, methyl vinyl ketone, propenal, propene, R-134a, tetrahydrofuran, trichloroethylene, uranyl fluoride, vinyl chloride, vinyl cyanide, vinyl ether.</p>	
Imaging and optical data	
IR resolution	320 × 240 pixels
Thermal sensitivity/NETD	<15 mK @ +30°C (+86°F)
Field of view (FOV)	24° × 18°
Minimum focus distance	0.3 m (1.0 ft.)
Focal length	23 mm (0.89 in.)
Lens identification	Automatic
F-number	1.5
Focus	Automatic (one touch) or manual (electric or on the lens)
Zoom	1–8× continuous, digital zoom
Digital image enhancement	Noise reduction filter, high sensitivity mode (HSM)
Detector data	
Detector type	Focal plane array (FPA), cooled QWIP
Spectral range	10.3–10.7 μm
Detector pitch	30 μm

Detector data	
Sensor cooling	Stirling Microcooler (FLIR MC-3)
Detects following gases	Sulfur Hexafluoride (SF6), Acetyl Chloride, Acetic Acid, Allyl Bromide, Allyl Chloride, Allyl Fluoride, Ammonia (NH3), Bromomethane, Chlorine Dioxide, Ethyl Cyanoacrylate, Ethylene, Furan, Hydrazine, Methylsilane, Methyl Ethyl Ketone, Methyl Vinyl Ketone, Propenal, Propene, R 134a, Tetrahydrofuran, Trichloroethylene, Uranyl Fluoride, Vinyl Chloride, Vinyl Cyanide, Vinyl Ether
Electronics and data rate	
Full frame rate	60 Hz
Image presentation	
Display	Built-in widescreen, 4.3 in. LCD, 800 × 480 pixels
Viewfinder	Built-in, tiltable OLED, 800 × 480 pixels
Automatic image adjustment	Continuous/manual; linear or histogram based
Manual image adjustment	Level/span
Image presentation modes	
Image modes	IR image, visual image, high sensitivity mode (HSM)
Measurement	
Temperature range	-40°C to +500°C (-40°F to +932°F)
Accuracy	±1°C (±1.8°F) for temperature range (0°C, to +100°C, +32°F to +212°F) or ±2% of reading for temperature range (>+100°C, >+212°F)
Measurement analysis	
Spotmeter	10
Area	5 boxes with max./min./average
Profile	1 live line (horizontal or vertical)
Difference temperature	Delta temperature between measurement functions or reference temperature
Reference temperature	Manually set or captured from any measurement function
Emissivity correction	Variable from 0.01 to 1.0 or selected from editable materials list
Reflected apparent temperature correction	Automatic, based on input of reflected temperature
Measurement corrections	Reflected temperature, distance, atmospheric transmission, humidity, external optics

Set-up	
Menu commands	Level, span Auto adjust continuous/manual/semi-automatic Zoom Palette Start/stop recording Store image Playback/recall image
Color palettes	Iron, Gray, Rainbow, Arctic, Lava, Rainbow HC
Set-up commands	1 programmable button, overlay recording mode, local adaptation of units, language, date and time formats
Storage of images	
Storage media	Removable SD or SDHC memory card , two card slots
Image storage capacity	> 1200 images (JPEG) with post process capability per GB on memory card
Image storage mode	IR/visual images Visual image can automatically be associated with corresponding IR image
Periodic image storage	Every 10 seconds up to 24 hours
File formats	Standard JPEG, 14 bit measurement data included
Geographic Information System	
GPS	Location data automatically added to every image from built-in GPS
Video recording in camera	
Radiometric IR video recording	*.seq video clips to memory card (7.5 and 15 Hz).
Non-radiometric IR video recording	MPEG4 (up to 60 minutes/clip) to memory card. Visual image can automatically be associated with corresponding recording of non-radiometric IR video.
Visual video recording	MPEG4 (25 minutes/clip) to memory card
Video streaming	
Radiometric IR video streaming	Full dynamic to PC using USB cable or to mobile devices using Wi-Fi. PC software capable of displaying the video stream include the following: <ul style="list-style-type: none"> • FLIR IR Camera Player • FLIR ResearchIR • FLIR Tools
Non-radiometric IR video streaming	RTP/MPEG4
Digital camera	
Built-in digital camera	3.2 Mpixels, auto focus, and two video lamps

Laser pointer	
Laser	Activated by dedicated button
Laser classification	Class 2
Laser type	Semiconductor AlGaInP diode laser, 1 mW, 635 nm (red)
USB	
USB	<ul style="list-style-type: none"> • USB-A: Connect external USB device • USB Mini-B: Data transfer to and from PC
USB, standard	USB Mini-B: 2.0 high speed
Composite video	
Video out	Digital video output (image)
Power system	
Battery type	Rechargeable Li ion battery
Battery voltage	7.2 V
Battery capacity	4.4 Ah
Battery operating time	> 2 hours at 25°C (+77°F) and typical use
Charging system	In camera (AC adapter or 12 V from a vehicle) or 2-bay charger
Charging time	2.5 h to 95% capacity, charging status indicated by LED's
External power operation	AC adapter 90–260 VAC, 50/60 Hz or 12 V from a vehicle (cable with standard plug, optional)
DC operation	10.8 to 16 V DC, polarity protected (proprietary protected)
Power	12.5 W typically
Start-up time	Typically 10 min. @ 25°C (+77°F)
Environmental data	
Operating temperature range	–20°C to +40°C (–4°F to +104°F)
Storage temperature range	–30°C to +60°C (–22°F to +140°F)
Humidity (operating and storage)	IEC 68-2-30/24 h 95% relative humidity +25°C to +40°C (+77°F to +104°F) (2 cycles)
Directives	<ul style="list-style-type: none"> • 73/23EEC • 2004/108/EC • 2002/95/EC • 2002/96/EC
EMC	<ul style="list-style-type: none"> • EN61000-6-4 (Emission) • EN61000-6-2 (Immunity) • FCC 47 CFR Part 15 class A (Emission) • EN 61 000-4-8, L5
Encapsulation	IP 54 (IEC 60529)
Shock	25 g (IEC 60068-2-27)
Vibration	2 g (IEC 60068-2-6)
Safety	Power supply: EN/UL/IEC 60950-1

Physical data	
Camera weight, excl. lens and battery	1.94 kg (4.27 lb.)
Camera weight, incl. lens and excl. battery	2.24 kg (4.94 lb.)
Camera weight, incl. lens and battery	2.48 kg (5.47 lb.)
Battery weight	0.24 kg (0.52 lb.)
Camera size, excl. lens (L x W x H)	284 x 169 x 161 mm (11.2 x 6.7 x 6.3 in.)
Cameras size, incl. lens (L x W x H)	306 x 169 x 161 mm (12.0 x 6.7 x 6.3 in.)
Battery size (L x W x H)	141 x 47 x 28 mm (5.5 x 1.8 x 1.1 in.)
Battery charger size (L x W x H)	158 x 122 x 25 mm (6.2 x 4.8 x 1.0 in.)
Tripod mounting	UNC ¼"-20
Housing material	Aluminum, magnesium
Grip material	TPE thermoplastic elastomers
Shipping information	
Packaging, type	Cardboard box
List of contents	<ul style="list-style-type: none"> • Infrared camera with lens • Battery charger • Battery, 2 ea. • Hard transport case • HDMI-DVI cable • HDMI-HDMI cable • Lens cap (mounted on lens) • Memory card • Power supply, incl. multi-plugs • Printed documentation • Shoulder strap • USB cable • Wi-Fi USB micro adapter (depending on CE and FCC regulations regarding wireless equipment for your country)
Packaging, weight	
Packaging, size	400 x 190 x 510 mm (15.7 x 7.5 x 20.1 in.)

Supplies & accessories:

- T197692; Battery charger, incl. power supply with multi plugs
- T910814; Power supply, incl. multi plugs
- T198511; Li-Ion Battery pack 7.4V 33Wh
- T199367ACC; Battery Li-ion 7.2 V, 4.4 Ah, 32 Wh
- T911650ACC; Memory card SD Card 8 GB
- 1910423; USB cable Std A <-> Mini-B
- T198509; Cigarette lighter adapter kit, 12 VDC, 1.2 m/3.9 ft.
- T910815ACC; HDMI to HDMI cable 1.5 m
- T910816ACC; HDMI to DVI cable 1.5 m
- T197555; Hard transport case for FLIR GF3xx-Series
- T951387; Wi-Fi USB micro adapter
- T198586; FLIR Reporter Professional (license only)
- T198584; FLIR Tools
- T198583; FLIR Tools+ (download card incl. license key)
- T198585; FLIR VideoReport
- DSW-10000; FLIR IR Camera Player
- APP-10002; FLIR Tools Mobile (Android Application)

- T198697; FLIR ResearchIR Max + HSDR 4 (hardware sec. dev.)
- T199014; FLIR ResearchIR Max + HSDR 4 (printed license key)
- T199044; FLIR ResearchIR Max + HSDR 4 Upgrade (printed license key)
- T198696; FLIR ResearchIR Max 4 (hardware sec. dev.)
- T199013; FLIR ResearchIR Max 4 (printed license key)
- T199043; FLIR ResearchIR Max 4 Upgrade (printed license key)
- T198731; FLIR ResearchIR Standard 4 (hardware sec. dev.)
- T199012; FLIR ResearchIR Standard 4 (printed license key)
- T199042; FLIR ResearchIR Standard 4 Upgrade (printed license key)
- T199233; FLIR Atlas SDK for .NET
- T199234; FLIR Atlas SDK for MATLAB
- T198567; ThermoVision™ System Developers Kit Ver. 2.6
- T198566; ThermoVision™ LabVIEW® Digital Toolkit Ver. 3.3

22.16 FLIR GF309 14.5°

P/N: 44601-0101

Rev.: 45202

General description	
<p>The FLIR GF309 is an infrared camera for furnace and high temperature inspection (e.g., of industrial furnaces, chemical heaters, and coal-fired boilers), without the need to shut down the operation. The portable camera also greatly improves operator safety, by measuring through flames at a safe distance, for all types of furnaces. A good knowledge of the furnace condition can avert failures and unscheduled shutdowns</p> <p>Industrial furnaces, heaters, and boilers are found in the chemical, petrochemical, and utility industries.</p>	
Benefits:	
<ul style="list-style-type: none"> Improved efficiency: The FLIR GF309 reduces inspection time by measuring the temperature through flames without the need to interrupt the industrial process or await scheduled service shutdowns. A furnace camera can help you to determine how to run a furnace/boiler efficiently to give the best fuel economy and maximize production output and quality. As the FLIR GF309 has a wide temperature range, high-accuracy electrical and mechanical inspections can be performed, which makes the camera even more useful for predictive maintenance. The wireless connectivity of the camera allows you to connect to smart phones or tablets for the wireless transfer of images or the remote control of the camera—a useful function if regulations require a second person to accompany the furnace inspector or thermal images needs to be sent quickly for a second opinion. Increased worker safety: High-temperature measurement can be performed through flames in a non-contact mode, and from a safe distance. Custom-built, the FLIR GF309 also features a detachable heat-shield designed to reflect heat away from the camera and the camera operator, providing increased protection. The camera is ergonomically designed, with a bright LCD and tiltable viewfinder, which facilitates its use over a full working day. Increased furnace safety: Good knowledge of furnace/boiler condition and operating parameters can provide the information needed to avert catastrophic failures and prevent unscheduled shutdowns. 	
Licensing and classification	
License information	Interchangeable lens version of the FLIR GF3XX series requires US Department of State License and will be subject to limitations on resale, except inside US. Allow a minimum of 90 days after application submittal for approval.
Imaging and optical data	
IR resolution	320 × 240 pixels
Thermal sensitivity/NETD	<15 mK @ +30°C (+86°F)
Field of view (FOV)	14.5° × 10.8°
Minimum focus distance	0.5 m (1.64 ft.)
Focal length	38 mm (1.49 in.)
Lens identification	Automatic
F-number	1.5
Focus	Automatic (one touch) or manual (electric or on the lens)
Zoom	1–8× continuous, digital zoom
Digital image enhancement	Noise reduction filter

Detector data	
Detector type	Focal plane array (FPA), cooled InSb
Spectral range	3.8–4.05 μm
Detector pitch	30 μm
Sensor cooling	Stirling Microcooler (FLIR MC-3)
Electronics and data rate	
Full frame rate	60 Hz
Image presentation	
Display	Built-in widescreen, 4.3 in. LCD, 800 × 480 pixels
Viewfinder	Built-in, tiltable OLED, 800 × 480 pixels
Automatic image adjustment	Continuous/manual; linear or histogram based
Manual image adjustment	Level/span
Image presentation modes	
Image modes	IR image, visual image
Measurement	
Temperature range	–20°C to +1500°C (–4°F to +2732°F)
Accuracy	$\pm 1^\circ\text{C}$ ($\pm 1.8^\circ\text{F}$) for temperature range (0°C, to +100°C, +32°F to +212°F) or $\pm 2\%$ of reading for temperature range (>+100°C, >+212°F)
Measurement analysis	
Spotmeter	10
Area	5 boxes with max./min./average
Profile	1 live line (horizontal or vertical)
Isotherm	Above/below/interval
Difference temperature	Delta temperature between measurement functions or reference temperature
Reference temperature	Manually set or captured from any measurement function
Emissivity correction	Variable from 0.01 to 1.0 or selected from editable materials list
Reflected apparent temperature correction	Automatic, based on input of reflected temperature
Measurement corrections	Reflected temperature, distance, atmospheric transmission, humidity, external optics

Set-up	
Menu commands	Level, span Auto adjust continuous/manual/semi-automatic Zoom Palette Start/stop recording Store image Playback/recall image
Color palettes	Iron, Gray, Rainbow, Arctic, Lava, Rainbow HC
Set-up commands	1 programmable button, local adaptation of units, language, date and time formats
Storage of images	
Storage media	Removable SD or SDHC memory card , two card slots
Image storage capacity	> 1200 images (JPEG) with post process capability per GB on memory card
Image storage mode	IR/visual images Visual image can automatically be associated with corresponding IR image
Periodic image storage	Every 10 seconds up to 24 hours
File formats	Standard JPEG, 14 bit measurement data included
Geographic Information System	
GPS	Location data automatically added to every image from built-in GPS
Video recording in camera	
Radiometric IR video recording	*.seq video clips to memory card (7.5 and 15 Hz).
Non-radiometric IR video recording	MPEG4 (up to 60 minutes/clip) to memory card. Visual image can automatically be associated with corresponding recording of non-radiometric IR video.
Visual video recording	MPEG4 (25 minutes/clip) to memory card
Video streaming	
Radiometric IR video streaming	Full dynamic to PC using USB cable or to mobile devices using Wi-Fi. PC software capable of displaying the video stream include the following: <ul style="list-style-type: none"> • FLIR IR Camera Player • FLIR ResearchIR • FLIR Tools
Non-radiometric IR video streaming	RTP/MPEG4
Digital camera	
Built-in digital camera	3.2 Mpixels, auto focus, and two video lamps

Laser pointer	
Laser	Activated by dedicated button
Laser classification	Class 2
Laser type	Semiconductor AlGaInP diode laser, 1 mW, 635 nm (red)
USB	
USB	<ul style="list-style-type: none"> • USB-A: Connect external USB device • USB Mini-B: Data transfer to and from PC
USB, standard	USB Mini-B: 2.0 high speed
Composite video	
Video out	Digital video output (image)
Power system	
Battery type	Rechargeable Li ion battery
Battery voltage	7.2 V
Battery capacity	4.4 Ah
Battery operating time	> 3 hours at 25°C (+77°F) and typical use
Charging system	In camera (AC adapter or 12 V from a vehicle) or 2-bay charger
Charging time	2.5 h to 95% capacity, charging status indicated by LED's
External power operation	AC adapter 90–260 VAC, 50/60 Hz or 12 V from a vehicle (cable with standard plug, optional)
DC operation	10.8 to 16 V DC, polarity protected (proprietary protected)
Power	8.5 W typically
Start-up time	Typically 7 min. @ 25°C (+77°F)
Environmental data	
Operating temperature range	–20°C to +50°C (–4°F to +122°F)
Storage temperature range	–30°C to +60°C (–22°F to +140°F)
Humidity (operating and storage)	IEC 68-2-30/24 h 95% relative humidity +25°C to +40°C (+77°F to +104°F) (2 cycles)
Directives	<ul style="list-style-type: none"> • 73/23EEC • 2004/108/EC • 2002/95/EC • 2002/96/EC
EMC	<ul style="list-style-type: none"> • EN61000-6-4 (Emission) • EN61000-6-2 (Immunity) • FCC 47 CFR Part 15 class A (Emission) • EN 61 000-4-8, L5
Encapsulation	IP 54 (IEC 60529)
Shock	25 g (IEC 60068-2-27)
Vibration	2 g (IEC 60068-2-6)
Safety	Power supply: EN/UL/IEC 60950-1

Physical data	
Camera weight, excl. lens and battery	1.94 kg (4.27 lb.)
Camera weight, incl. lens and excl. battery	2.24 kg (4.94 lb.)
Camera weight, incl. lens and battery	2.48 kg (5.47 lb.)
Battery weight	0.24 kg (0.52 lb.)
Heat shield weight	0.50 kg (1.09 lb.)
Camera size, excl. lens (L x W x H)	284 x 169 x 161 mm (11.2 x 6.7 x 6.3 in.)
Cameras size, incl. lens (L x W x H)	305 x 169 x 161 mm (12.0 x 6.7 x 6.3 in.)
Cameras size, incl. heat shield (L x W x H)	320 x 243 x 195 mm (12.6 x 9.6 x 7.7 in.)
Battery size (L x W x H)	141 x 47 x 28 mm (5.5 x 1.8 x 1.1 in.)
Battery charger size (L x W x H)	158 x 122 x 25 mm (6.2 x 4.8 x 1.0 in.)
Tripod mounting	UNC ¼"-20
Housing material	Aluminum, magnesium
Grip material	TPE thermoplastic elastomers
Shipping information	
Packaging, type	Cardboard box
List of contents	<ul style="list-style-type: none"> • Infrared camera with lens • Battery charger • Battery, 2 ea. • Hard transport case • HDMI-DVI cable • HDMI-HDMI cable • Heat shield • Lens cap (2 ea.) • Lens cap (mounted on lens) • Memory card • Power supply, incl. multi-plugs • Printed documentation • Shoulder strap • USB cable • Wi-Fi USB micro adapter (depending on CE and FCC regulations regarding wireless equipment for your country)
Packaging, weight	
Packaging, size	400 x 190 x 510 mm (15.7 x 7.5 x 20.1 in.)

Supplies & accessories:

- T197387; IR lens, 24° with case for GF300, GF309, GF320
- T197388; IR lens, 6° with case for GF300, GF309, GF320, GF346.
- T197385; IR lens, 14.5° with case for GF300, GF309, GF320
- T198361; Furnace IR lens extender, 14.5° with case for GF309
- T197692; Battery charger, incl. power supply with multi plugs
- T910814; Power supply, incl. multi plugs
- T198511; Li-Ion Battery pack 7.4V 33Wh
- T199367ACC; Battery Li-ion 7.2 V, 4.4 Ah, 32 Wh
- T911650ACC; Memory card SD Card 8 GB
- 1910423; USB cable Std A <-> Mini-B
- T198509; Cigarette lighter adapter kit, 12 VDC, 1.2 m/3.9 ft.
- T910815ACC; HDMI to HDMI cable 1.5 m
- T910816ACC; HDMI to DVI cable 1.5 m

- T197555; Hard transport case for FLIR GF3xx-Series
- T951387; Wi-Fi USB micro adapter
- T197482; Heat Shield for FLIR GF309
- T198586; FLIR Reporter Professional (license only)
- T198584; FLIR Tools
- T198583; FLIR Tools+ (download card incl. license key)
- DSW-10000; FLIR IR Camera Player
- APP-10002; FLIR Tools Mobile (Android Application)
- T198697; FLIR ResearchIR Max + HSDR 4 (hardware sec. dev.)
- T199014; FLIR ResearchIR Max + HSDR 4 (printed license key)
- T199044; FLIR ResearchIR Max + HSDR 4 Upgrade (printed license key)
- T198696; FLIR ResearchIR Max 4 (hardware sec. dev.)
- T199013; FLIR ResearchIR Max 4 (printed license key)
- T199043; FLIR ResearchIR Max 4 Upgrade (printed license key)
- T198731; FLIR ResearchIR Standard 4 (hardware sec. dev.)
- T199012; FLIR ResearchIR Standard 4 (printed license key)
- T199042; FLIR ResearchIR Standard 4 Upgrade (printed license key)
- T199233; FLIR Atlas SDK for .NET
- T199234; FLIR Atlas SDK for MATLAB
- T198567; ThermoVision™ System Developers Kit Ver. 2.6
- T198566; ThermoVision™ LabVIEW® Digital Toolkit Ver. 3.3

22.17 FLIR GF309 14.5° Fixed lens

P/N: 44602-0101

Rev.: 45202

General description	
<p>The FLIR GF309 is an infrared camera for furnace and high temperature inspection (e.g., of industrial furnaces, chemical heaters, and coal-fired boilers), without the need to shut down the operation. The portable camera also greatly improves operator safety, by measuring through flames at a safe distance, for all types of furnaces. A good knowledge of the furnace condition can avert failures and unscheduled shutdowns</p> <p>Industrial furnaces, heaters, and boilers are found in the chemical, petrochemical, and utility industries.</p>	
Benefits:	
<ul style="list-style-type: none"> Improved efficiency: The FLIR GF309 reduces inspection time by measuring the temperature through flames without the need to interrupt the industrial process or await scheduled service shutdowns. A furnace camera can help you to determine how to run a furnace/boiler efficiently to give the best fuel economy and maximize production output and quality. As the FLIR GF309 has a wide temperature range, high-accuracy electrical and mechanical inspections can be performed, which makes the camera even more useful for predictive maintenance. The wireless connectivity of the camera allows you to connect to smart phones or tablets for the wireless transfer of images or the remote control of the camera—a useful function if regulations require a second person to accompany the furnace inspector or thermal images needs to be sent quickly for a second opinion. Increased worker safety: High-temperature measurement can be performed through flames in a non-contact mode, and from a safe distance. Custom-built, the FLIR GF309 also features a detachable heat-shield designed to reflect heat away from the camera and the camera operator, providing increased protection. The camera is ergonomically designed, with a bright LCD and tiltable viewfinder, which facilitates its use over a full working day. Increased furnace safety: Good knowledge of furnace/boiler condition and operating parameters can provide the information needed to avert catastrophic failures and prevent unscheduled shutdowns. 	
Imaging and optical data	
IR resolution	320 × 240 pixels
Thermal sensitivity/NETD	<15 mK @ +30°C (+86°F)
Field of view (FOV)	14.5° × 10.8°
Minimum focus distance	0.5 m (1.64 ft.)
Focal length	38 mm (1.49 in.)
Lens identification	Automatic
F-number	1.5
Focus	Automatic (one touch) or manual (electric or on the lens)
Zoom	1–8× continuous, digital zoom
Digital image enhancement	Noise reduction filter
Detector data	
Detector type	Focal plane array (FPA), cooled InSb
Spectral range	3.8–4.05 μm
Detector pitch	30 μm
Sensor cooling	Stirling Microcooler (FLIR MC-3)
Electronics and data rate	
Full frame rate	60 Hz

Image presentation	
Display	Built-in widescreen, 4.3 in. LCD, 800 × 480 pixels
Viewfinder	Built-in, tiltable OLED, 800 × 480 pixels
Automatic image adjustment	Continuous/manual; linear or histogram based
Manual image adjustment	Level/span
Image presentation modes	
Image modes	IR image, visual image
Measurement	
Temperature range	-20°C to +1500°C (-4°F to +2732°F)
Accuracy	±1°C (±1.8°F) for temperature range (0°C, to +100°C, +32°F to +212°F) or ±2% of reading for temperature range (>+100°C, >+212°F)
Measurement analysis	
Spotmeter	10
Area	5 boxes with max./min./average
Profile	1 live line (horizontal or vertical)
Isotherm	Above/below/interval
Difference temperature	Delta temperature between measurement functions or reference temperature
Reference temperature	Manually set or captured from any measurement function
Emissivity correction	Variable from 0.01 to 1.0 or selected from editable materials list
Reflected apparent temperature correction	Automatic, based on input of reflected temperature
Measurement corrections	Reflected temperature, distance, atmospheric transmission, humidity, external optics
Set-up	
Menu commands	Level, span Auto adjust continuous/manual/semi-automatic Zoom Palette Start/stop recording Store image Playback/recall image
Color palettes	Iron, Gray, Rainbow, Arctic, Lava, Rainbow HC
Set-up commands	1 programmable button, local adaptation of units, language, date and time formats
Storage of images	
Storage media	Removable SD or SDHC memory card , two card slots
Image storage capacity	> 1200 images (JPEG) with post process capability per GB on memory card

Storage of images	
Image storage mode	IR/visual images Visual image can automatically be associated with corresponding IR image
Periodic image storage	Every 10 seconds up to 24 hours
File formats	Standard JPEG, 14 bit measurement data included
Geographic Information System	
GPS	Location data automatically added to every image from built-in GPS
Video recording in camera	
Radiometric IR video recording	*.seq video clips to memory card (7.5 and 15 Hz).
Non-radiometric IR video recording	MPEG4 (up to 60 minutes/clip) to memory card. Visual image can automatically be associated with corresponding recording of non-radiometric IR video.
Visual video recording	MPEG4 (25 minutes/clip) to memory card
Video streaming	
Radiometric IR video streaming	Full dynamic to PC using USB cable or to mobile devices using Wi-Fi. PC software capable of displaying the video stream include the following: <ul style="list-style-type: none"> • FLIR IR Camera Player • FLIR ResearchIR • FLIR Tools
Non-radiometric IR video streaming	RTP/MPEG4
Digital camera	
Built-in digital camera	3.2 Mpixels, auto focus, and two video lamps
Laser pointer	
Laser	Activated by dedicated button
Laser classification	Class 2
Laser type	Semiconductor AlGaInP diode laser, 1 mW, 635 nm (red)
USB	
USB	<ul style="list-style-type: none"> • USB-A: Connect external USB device • USB Mini-B: Data transfer to and from PC
USB, standard	USB Mini-B: 2.0 high speed
Composite video	
Video out	Digital video output (image)
Power system	
Battery type	Rechargeable Li ion battery
Battery voltage	7.2 V
Battery capacity	4.4 Ah
Battery operating time	> 3 hours at 25°C (+77°F) and typical use

Power system	
Charging system	In camera (AC adapter or 12 V from a vehicle) or 2-bay charger
Charging time	2.5 h to 95% capacity, charging status indicated by LED's
External power operation	AC adapter 90–260 VAC, 50/60 Hz or 12 V from a vehicle (cable with standard plug, optional)
DC operation	10.8 to 16 V DC, polarity protected (proprietary protected)
Power	8.5 W typically
Start-up time	Typically 7 min. @ 25°C (+77°F)
Environmental data	
Operating temperature range	–20°C to +50°C (–4°F to +122°F)
Storage temperature range	–30°C to +60°C (–22°F to +140°F)
Humidity (operating and storage)	IEC 68-2-30/24 h 95% relative humidity +25°C to +40°C (+77°F to +104°F) (2 cycles)
Directives	<ul style="list-style-type: none"> • 73/23EEC • 2004/108/EC • 2002/95/EC • 2002/96/EC
EMC	<ul style="list-style-type: none"> • EN61000-6-4 (Emission) • EN61000-6-2 (Immunity) • FCC 47 CFR Part 15 class A (Emission) • EN 61 000-4-8, L5
Encapsulation	IP 54 (IEC 60529)
Shock	25 g (IEC 60068-2-27)
Vibration	2 g (IEC 60068-2-6)
Safety	Power supply: EN/UL/IEC 60950-1
Physical data	
Camera weight, excl. lens and battery	1.94 kg (4.27 lb.)
Camera weight, incl. lens and excl. battery	2.24 kg (4.94 lb.)
Camera weight, incl. lens and battery	2.48 kg (5.47 lb.)
Battery weight	0.24 kg (0.52 lb.)
Heat shield weight	0.50 kg (1.09 lb.)
Camera size, excl. lens (L × W × H)	284 × 169 × 161 mm (11.2 × 6.7 × 6.3 in.)
Cameras size, incl. lens (L × W × H)	305 × 169 × 161 mm (12.0 × 6.7 × 6.3 in.)
Cameras size, incl. heat shield (L × W × H)	320 × 243 × 195 mm (12.6 × 9.6 × 7.7 in.)
Battery size (L × W × H)	141 × 47 × 28 mm (5.5 × 1.8 × 1.1 in.)
Battery charger size (L × W × H)	158 × 122 × 25 mm (6.2 × 4.8 × 1.0 in.)
Tripod mounting	UNC ¼"-20
Housing material	Aluminum, magnesium
Grip material	TPE thermoplastic elastomers

Shipping information	
Packaging, type	Cardboard box
List of contents	<ul style="list-style-type: none"> • Infrared camera with lens • Battery charger • Battery, 2 ea. • Hard transport case • HDMI-DVI cable • HDMI-HDMI cable • Heat shield • Lens cap (mounted on lens) • Memory card • Power supply, incl. multi-plugs • Printed documentation • Shoulder strap • USB cable • Wi-Fi USB micro adapter (depending on CE and FCC regulations regarding wireless equipment for your country)
Packaging, weight	
Packaging, size	400 × 190 × 510 mm (15.7 × 7.5 × 20.1 in.)

Supplies & accessories:

- T198361; Furnace IR lens extender, 14.5° with case for GF309
- T197692; Battery charger, incl. power supply with multi plugs
- T910814; Power supply, incl. multi plugs
- T198511; Li-Ion Battery pack 7.4V 33Wh
- T199367ACC; Battery Li-ion 7.2 V, 4.4 Ah, 32 Wh
- T911650ACC; Memory card SD Card 8 GB
- 1910423; USB cable Std A <-> Mini-B
- T198509; Cigarette lighter adapter kit, 12 VDC, 1.2 m/3.9 ft.
- T910815ACC; HDMI to HDMI cable 1.5 m
- T910816ACC; HDMI to DVI cable 1.5 m
- T197555; Hard transport case for FLIR GF3xx-Series
- T951387; Wi-Fi USB micro adapter
- T197482; Heat Shield for FLIR GF309
- T198586; FLIR Reporter Professional (license only)
- T198584; FLIR Tools
- T198583; FLIR Tools+ (download card incl. license key)
- DSW-10000; FLIR IR Camera Player
- APP-10002; FLIR Tools Mobile (Android Application)
- T198697; FLIR ResearchIR Max + HSDR 4 (hardware sec. dev.)
- T199014; FLIR ResearchIR Max + HSDR 4 (printed license key)
- T199044; FLIR ResearchIR Max + HSDR 4 Upgrade (printed license key)
- T198696; FLIR ResearchIR Max 4 (hardware sec. dev.)
- T199013; FLIR ResearchIR Max 4 (printed license key)
- T199043; FLIR ResearchIR Max 4 Upgrade (printed license key)
- T198731; FLIR ResearchIR Standard 4 (hardware sec. dev.)
- T199012; FLIR ResearchIR Standard 4 (printed license key)
- T199042; FLIR ResearchIR Standard 4 Upgrade (printed license key)
- T199233; FLIR Atlas SDK for .NET
- T199234; FLIR Atlas SDK for MATLAB
- T198567; ThermoVision™ System Developers Kit Ver. 2.6
- T198566; ThermoVision™ LabVIEW® Digital Toolkit Ver. 3.3

22.18 FLIR GF309 24°

P/N: 44601-0102

Rev.: 45202

General description	
<p>The FLIR GF309 is an infrared camera for furnace and high temperature inspection (e.g., of industrial furnaces, chemical heaters, and coal-fired boilers), without the need to shut down the operation. The portable camera also greatly improves operator safety, by measuring through flames at a safe distance, for all types of furnaces. A good knowledge of the furnace condition can avert failures and unscheduled shutdowns</p> <p>Industrial furnaces, heaters, and boilers are found in the chemical, petrochemical, and utility industries.</p>	
Benefits:	
<ul style="list-style-type: none"> Improved efficiency: The FLIR GF309 reduces inspection time by measuring the temperature through flames without the need to interrupt the industrial process or await scheduled service shutdowns. A furnace camera can help you to determine how to run a furnace/boiler efficiently to give the best fuel economy and maximize production output and quality. As the FLIR GF309 has a wide temperature range, high-accuracy electrical and mechanical inspections can be performed, which makes the camera even more useful for predictive maintenance. The wireless connectivity of the camera allows you to connect to smart phones or tablet PCs for the wireless transfer of images or the remote control of the camera—a useful function if regulations require a second person to accompany the furnace inspector or thermal images needs to be sent quickly for a second opinion. Increased worker safety: High-temperature measurement can be performed through flames in a non-contact mode, and from a safe distance. Custom-built, the FLIR GF309 also features a detachable heat-shield designed to reflect heat away from the camera and the camera operator, providing increased protection. The camera is ergonomically designed with a bright LCD and tiltable viewfinder, which facilitates its use over a full working day. Increased furnace safety: Good knowledge of furnace/boiler condition and operating parameters can provide the information needed to avert catastrophic failures and prevent unscheduled shutdowns. 	
Licensing and classification	
License information	Interchangeable lens version of the FLIR GF3XX series requires US Department of State License and will be subject to limitations on resale, except inside US. Allow a minimum of 90 days after application submittal for approval.
Imaging and optical data	
IR resolution	320 × 240 pixels
Thermal sensitivity/NETD	<15 mK @ +30°C (+86°F)
Field of view (FOV)	24° × 18°
Minimum focus distance	0.3 m (1.0 ft.)
Focal length	23 mm (0.89 in.)
Lens identification	Automatic
F-number	1.5
Focus	Automatic (one touch) or manual (electric or on the lens)
Zoom	1–8× continuous, digital zoom
Digital image enhancement	Noise reduction filter

Detector data	
Detector type	Focal plane array (FPA), cooled InSb
Spectral range	3.8–4.05 μm
Detector pitch	30 μm
Sensor cooling	Stirling Microcooler (FLIR MC-3)
Electronics and data rate	
Full frame rate	60 Hz
Image presentation	
Display	Built-in widescreen, 4.3 in. LCD, 800 × 480 pixels
Viewfinder	Built-in, tiltable OLED, 800 × 480 pixels
Automatic image adjustment	Continuous/manual; linear or histogram based
Manual image adjustment	Level/span
Image presentation modes	
Image modes	IR image, visual image
Measurement	
Temperature range	–20°C to +1500°C (–4°F to +2732°F)
Accuracy	$\pm 1^\circ\text{C}$ ($\pm 1.8^\circ\text{F}$) for temperature range (0°C, to +100°C, +32°F to +212°F) or $\pm 2\%$ of reading for temperature range (>+100°C, >+212°F)
Measurement analysis	
Spotmeter	10
Area	5 boxes with max./min./average
Profile	1 live line (horizontal or vertical)
Isotherm	Above/below/interval
Difference temperature	Delta temperature between measurement functions or reference temperature
Reference temperature	Manually set or captured from any measurement function
Emissivity correction	Variable from 0.01 to 1.0 or selected from editable materials list
Reflected apparent temperature correction	Automatic, based on input of reflected temperature
Measurement corrections	Reflected temperature, distance, atmospheric transmission, humidity, external optics

Set-up	
Menu commands	Level, span Auto adjust continuous/manual/semi-automatic Zoom Palette Start/stop recording Store image Playback/recall image
Color palettes	Iron, Gray, Rainbow, Arctic, Lava, Rainbow HC
Set-up commands	1 programmable button, local adaptation of units, language, date and time formats
Storage of images	
Storage media	Removable SD or SDHC memory card , two card slots
Image storage capacity	> 1200 images (JPEG) with post process capability per GB on memory card
Image storage mode	IR/visual images Visual image can automatically be associated with corresponding IR image
Periodic image storage	Every 10 seconds up to 24 hours
File formats	Standard JPEG, 14 bit measurement data included
Geographic Information System	
GPS	Location data automatically added to every image from built-in GPS
Video recording in camera	
Radiometric IR video recording	*.seq video clips to memory card (7.5 and 15 Hz).
Non-radiometric IR video recording	MPEG4 (up to 60 minutes/clip) to memory card. Visual image can automatically be associated with corresponding recording of non-radiometric IR video.
Visual video recording	MPEG4 (25 minutes/clip) to memory card
Video streaming	
Radiometric IR video streaming	Full dynamic to PC using USB cable or to mobile devices using Wi-Fi. PC software capable of displaying the video stream include the following: <ul style="list-style-type: none"> • FLIR IR Camera Player • FLIR ResearchIR • FLIR Tools
Non-radiometric IR video streaming	RTP/MPEG4
Digital camera	
Built-in digital camera	3.2 Mpixels, auto focus, and two video lamps

Laser pointer	
Laser	Activated by dedicated button
Laser classification	Class 2
Laser type	Semiconductor AlGaInP diode laser, 1 mW, 635 nm (red)
USB	
USB	<ul style="list-style-type: none"> • USB-A: Connect external USB device • USB Mini-B: Data transfer to and from PC
USB, standard	USB Mini-B: 2.0 high speed
Composite video	
Video out	Digital video output (image)
Power system	
Battery type	Rechargeable Li ion battery
Battery voltage	7.2 V
Battery capacity	4.4 Ah
Battery operating time	> 3 hours at 25°C (+77°F) and typical use
Charging system	In camera (AC adapter or 12 V from a vehicle) or 2-bay charger
Charging time	2.5 h to 95% capacity, charging status indicated by LED's
External power operation	AC adapter 90–260 VAC, 50/60 Hz or 12 V from a vehicle (cable with standard plug, optional)
DC operation	10.8 to 16 V DC, polarity protected (proprietary protected)
Power	8.5 W typically
Start-up time	Typically 7 min. @ 25°C (+77°F)
Environmental data	
Operating temperature range	–20°C to +50°C (–4°F to +122°F)
Storage temperature range	–30°C to +60°C (–22°F to +140°F)
Humidity (operating and storage)	IEC 68-2-30/24 h 95% relative humidity +25°C to +40°C (+77°F to +104°F) (2 cycles)
Directives	<ul style="list-style-type: none"> • 73/23EEC • 2004/108/EC • 2002/95/EC • 2002/96/EC
EMC	<ul style="list-style-type: none"> • EN61000-6-4 (Emission) • EN61000-6-2 (Immunity) • FCC 47 CFR Part 15 class A (Emission) • EN 61 000-4-8, L5
Encapsulation	IP 54 (IEC 60529)
Shock	25 g (IEC 60068-2-27)
Vibration	2 g (IEC 60068-2-6)
Safety	Power supply: EN/UL/IEC 60950-1

Physical data	
Camera weight, excl. lens and battery	1.94 kg (4.27 lb.)
Camera weight, incl. lens and excl. battery	2.24 kg (4.94 lb.)
Camera weight, incl. lens and battery	2.48 kg (5.47 lb.)
Battery weight	0.24 kg (0.52 lb.)
Heat shield weight	0.50 kg (1.09 lb.)
Camera size, excl. lens (L x W x H)	284 x 169 x 161 mm (11.2 x 6.7 x 6.3 in.)
Cameras size, incl. lens (L x W x H)	306 x 169 x 161 mm (12.0 x 6.7 x 6.3 in.)
Cameras size, incl. heat shield (L x W x H)	320 x 243 x 195 mm (12.6 x 9.6 x 7.7 in.)
Battery size (L x W x H)	141 x 47 x 28 mm (5.5 x 1.8 x 1.1 in.)
Battery charger size (L x W x H)	158 x 122 x 25 mm (6.2 x 4.8 x 1.0 in.)
Tripod mounting	UNC ¼"-20
Housing material	Aluminum, magnesium
Grip material	TPE thermoplastic elastomers
Shipping information	
Packaging, type	Cardboard box
List of contents	<ul style="list-style-type: none"> • Infrared camera with lens • Battery charger • Battery, 2 ea. • Hard transport case • HDMI-DVI cable • HDMI-HDMI cable • Heat shield • Lens cap (2 ea.) • Lens cap (mounted on lens) • Memory card • Power supply, incl. multi-plugs • Printed documentation • Shoulder strap • USB cable • Wi-Fi USB micro adapter (depending on CE and FCC regulations regarding wireless equipment for your country)
Packaging, weight	
Packaging, size	400 x 190 x 510 mm (15.7 x 7.5 x 20.1 in.)

Supplies & accessories:

- T197387; IR lens, 24° with case for GF300, GF309, GF320
- T197388; IR lens, 6° with case for GF300, GF309, GF320, GF346.
- T197385; IR lens, 14.5° with case for GF300, GF309, GF320
- T198360; Furnace IR lens extender, 24° with case for GF309
- T197692; Battery charger, incl. power supply with multi plugs
- T910814; Power supply, incl. multi plugs
- T198511; Li-Ion Battery pack 7.4V 33Wh
- T199367ACC; Battery Li-ion 7.2 V, 4.4 Ah, 32 Wh
- T911650ACC; Memory card SD Card 8 GB
- 1910423; USB cable Std A <-> Mini-B
- T198509; Cigarette lighter adapter kit, 12 VDC, 1.2 m/3.9 ft.
- T910815ACC; HDMI to HDMI cable 1.5 m
- T910816ACC; HDMI to DVI cable 1.5 m

- T197555; Hard transport case for FLIR GF3xx-Series
- T951387; Wi-Fi USB micro adapter
- T197482; Heat Shield for FLIR GF309
- T198586; FLIR Reporter Professional (license only)
- T198584; FLIR Tools
- T198583; FLIR Tools+ (download card incl. license key)
- DSW-10000; FLIR IR Camera Player
- APP-10002; FLIR Tools Mobile (Android Application)
- T198697; FLIR ResearchIR Max + HSDR 4 (hardware sec. dev.)
- T199014; FLIR ResearchIR Max + HSDR 4 (printed license key)
- T199044; FLIR ResearchIR Max + HSDR 4 Upgrade (printed license key)
- T198696; FLIR ResearchIR Max 4 (hardware sec. dev.)
- T199013; FLIR ResearchIR Max 4 (printed license key)
- T199043; FLIR ResearchIR Max 4 Upgrade (printed license key)
- T198731; FLIR ResearchIR Standard 4 (hardware sec. dev.)
- T199012; FLIR ResearchIR Standard 4 (printed license key)
- T199042; FLIR ResearchIR Standard 4 Upgrade (printed license key)
- T199233; FLIR Atlas SDK for .NET
- T199234; FLIR Atlas SDK for MATLAB
- T198567; ThermoVision™ System Developers Kit Ver. 2.6
- T198566; ThermoVision™ LabVIEW® Digital Toolkit Ver. 3.3

22.19 FLIR GF309 24° Fixed lens

P/N: 44602-0102

Rev.: 45202

General description	
<p>The FLIR GF309 is an infrared camera for furnace and high temperature inspection (e.g., of industrial furnaces, chemical heaters, and coal-fired boilers), without the need to shut down the operation. The portable camera also greatly improves operator safety, by measuring through flames at a safe distance, for all types of furnaces. A good knowledge of the furnace condition can avert failures and unscheduled shutdowns</p> <p>Industrial furnaces, heaters, and boilers are found in the chemical, petrochemical, and utility industries.</p>	
Benefits:	
<ul style="list-style-type: none"> Improved efficiency: The FLIR GF309 reduces inspection time by measuring the temperature through flames without the need to interrupt the industrial process or await scheduled service shutdowns. A furnace camera can help you to determine how to run a furnace/boiler efficiently to give the best fuel economy and maximize production output and quality. As the FLIR GF309 has a wide temperature range, high-accuracy electrical and mechanical inspections can be performed, which makes the camera even more useful for predictive maintenance. The wireless connectivity of the camera allows you to connect to smart phones or tablets for the wireless transfer of images or the remote control of the camera—a useful function if regulations require a second person to accompany the furnace inspector or thermal images needs to be sent quickly for a second opinion. Increased worker safety: High-temperature measurement can be performed through flames in a non-contact mode, and from a safe distance. Custom-built, the FLIR GF309 also features a detachable heat-shield designed to reflect heat away from the camera and the camera operator, providing increased protection. The camera is ergonomically designed, with a bright LCD and tiltable viewfinder, which facilitates its use over a full working day. Increased furnace safety: Good knowledge of furnace/boiler condition and operating parameters can provide the information needed to avert catastrophic failures and prevent unscheduled shutdowns. 	
Imaging and optical data	
IR resolution	320 × 240 pixels
Thermal sensitivity/NETD	<15 mK @ +30°C (+86°F)
Field of view (FOV)	24° × 18°
Minimum focus distance	0.3 m (1.0 ft.)
Focal length	23 mm (0.89 in.)
Lens identification	Automatic
F-number	1.5
Focus	Automatic (one touch) or manual (electric or on the lens)
Zoom	1–8× continuous, digital zoom
Digital image enhancement	Noise reduction filter
Detector data	
Detector type	Focal plane array (FPA), cooled InSb
Spectral range	3.8–4.05 μm
Detector pitch	30 μm
Sensor cooling	Stirling Microcooler (FLIR MC-3)
Electronics and data rate	
Full frame rate	60 Hz

Image presentation	
Display	Built-in widescreen, 4.3 in. LCD, 800 × 480 pixels
Viewfinder	Built-in, tiltable OLED, 800 × 480 pixels
Automatic image adjustment	Continuous/manual; linear or histogram based
Manual image adjustment	Level/span
Image presentation modes	
Image modes	IR image, visual image
Measurement	
Temperature range	-20°C to +1500°C (-4°F to +2732°F)
Accuracy	±1°C (±1.8°F) for temperature range (0°C, to +100°C, +32°F to +212°F) or ±2% of reading for temperature range (>+100°C, >+212°F)
Measurement analysis	
Spotmeter	10
Area	5 boxes with max./min./average
Profile	1 live line (horizontal or vertical)
Isotherm	Above/below/interval
Difference temperature	Delta temperature between measurement functions or reference temperature
Reference temperature	Manually set or captured from any measurement function
Emissivity correction	Variable from 0.01 to 1.0 or selected from editable materials list
Reflected apparent temperature correction	Automatic, based on input of reflected temperature
Measurement corrections	Reflected temperature, distance, atmospheric transmission, humidity, external optics
Set-up	
Menu commands	Level, span Auto adjust continuous/manual/semi-automatic Zoom Palette Start/stop recording Store image Playback/recall image
Color palettes	Iron, Gray, Rainbow, Arctic, Lava, Rainbow HC
Set-up commands	1 programmable button, local adaptation of units, language, date and time formats
Storage of images	
Storage media	Removable SD or SDHC memory card , two card slots
Image storage capacity	> 1200 images (JPEG) with post process capability per GB on memory card

Storage of images	
Image storage mode	IR/visual images Visual image can automatically be associated with corresponding IR image
Periodic image storage	Every 10 seconds up to 24 hours
File formats	Standard JPEG, 14 bit measurement data included
Geographic Information System	
GPS	Location data automatically added to every image from built-in GPS
Video recording in camera	
Radiometric IR video recording	*.seq video clips to memory card (7.5 and 15 Hz).
Non-radiometric IR video recording	MPEG4 (up to 60 minutes/clip) to memory card. Visual image can automatically be associated with corresponding recording of non-radiometric IR video.
Visual video recording	MPEG4 (25 minutes/clip) to memory card
Video streaming	
Radiometric IR video streaming	Full dynamic to PC using USB cable or to mobile devices using Wi-Fi. PC software capable of displaying the video stream include the following: <ul style="list-style-type: none"> • FLIR IR Camera Player • FLIR ResearchIR • FLIR Tools
Non-radiometric IR video streaming	RTP/MPEG4
Digital camera	
Built-in digital camera	3.2 Mpixels, auto focus, and two video lamps
Laser pointer	
Laser	Activated by dedicated button
Laser classification	Class 2
Laser type	Semiconductor AlGaInP diode laser, 1 mW, 635 nm (red)
USB	
USB	<ul style="list-style-type: none"> • USB-A: Connect external USB device • USB Mini-B: Data transfer to and from PC
USB, standard	USB Mini-B: 2.0 high speed
Composite video	
Video out	Digital video output (image)
Power system	
Battery type	Rechargeable Li ion battery
Battery voltage	7.2 V
Battery capacity	4.4 Ah
Battery operating time	> 3 hours at 25°C (+77°F) and typical use

Power system	
Charging system	In camera (AC adapter or 12 V from a vehicle) or 2-bay charger
Charging time	2.5 h to 95% capacity, charging status indicated by LED's
External power operation	AC adapter 90–260 VAC, 50/60 Hz or 12 V from a vehicle (cable with standard plug, optional)
DC operation	10.8 to 16 V DC, polarity protected (proprietary protected)
Power	8.5 W typically
Start-up time	Typically 7 min. @ 25°C (+77°F)
Environmental data	
Operating temperature range	–20°C to +50°C (–4°F to +122°F)
Storage temperature range	–30°C to +60°C (–22°F to +140°F)
Humidity (operating and storage)	IEC 68-2-30/24 h 95% relative humidity +25°C to +40°C (+77°F to +104°F) (2 cycles)
Directives	<ul style="list-style-type: none"> • 73/23EEC • 2004/108/EC • 2002/95/EC • 2002/96/EC
EMC	<ul style="list-style-type: none"> • EN61000-6-4 (Emission) • EN61000-6-2 (Immunity) • FCC 47 CFR Part 15 class A (Emission) • EN 61 000-4-8, L5
Encapsulation	IP 54 (IEC 60529)
Shock	25 g (IEC 60068-2-27)
Vibration	2 g (IEC 60068-2-6)
Safety	Power supply: EN/UL/IEC 60950-1
Physical data	
Camera weight, excl. lens and battery	1.94 kg (4.27 lb.)
Camera weight, incl. lens and excl. battery	2.24 kg (4.94 lb.)
Camera weight, incl. lens and battery	2.48 kg (5.47 lb.)
Battery weight	0.24 kg (0.52 lb.)
Heat shield weight	0.50 kg (1.09 lb.)
Camera size, excl. lens (L × W × H)	284 × 169 × 161 mm (11.2 × 6.7 × 6.3 in.)
Cameras size, incl. lens (L × W × H)	306 × 169 × 161 mm (12.0 × 6.7 × 6.3 in.)
Cameras size, incl. heat shield (L × W × H)	320 × 243 × 195 mm (12.6 × 9.6 × 7.7 in.)
Battery size (L × W × H)	141 × 47 × 28 mm (5.5 × 1.8 × 1.1 in.)
Battery charger size (L × W × H)	158 × 122 × 25 mm (6.2 × 4.8 × 1.0 in.)
Tripod mounting	UNC ¼"-20
Housing material	Aluminum, magnesium
Grip material	TPE thermoplastic elastomers

Shipping information	
Packaging, type	Cardboard box
List of contents	<ul style="list-style-type: none"> • Infrared camera with lens • Battery charger • Battery, 2 ea. • Hard transport case • HDMI-DVI cable • HDMI-HDMI cable • Heat shield • Lens cap (mounted on lens) • Memory card • Power supply, incl. multi-plugs • Printed documentation • Shoulder strap • USB cable • Wi-Fi USB micro adapter (depending on CE and FCC regulations regarding wireless equipment for your country)
Packaging, weight	9.45 kg (20.8 lb.)
Packaging, size	400 × 190 × 510 mm (15.7 × 7.5 × 20.1 in.)

Supplies & accessories:

- T198360; Furnace IR lens extender, 24° with case for GF309
- T197692; Battery charger, incl. power supply with multi plugs
- T910814; Power supply, incl. multi plugs
- T198511; Li-Ion Battery pack 7.4V 33Wh
- T199367ACC; Battery Li-ion 7.2 V, 4.4 Ah, 32 Wh
- T911650ACC; Memory card SD Card 8 GB
- 1910423; USB cable Std A <-> Mini-B
- T198509; Cigarette lighter adapter kit, 12 VDC, 1.2 m/3.9 ft.
- T910815ACC; HDMI to HDMI cable 1.5 m
- T910816ACC; HDMI to DVI cable 1.5 m
- T197555; Hard transport case for FLIR GF3xx-Series
- T951387; Wi-Fi USB micro adapter
- T197482; Heat Shield for FLIR GF309
- T198586; FLIR Reporter Professional (license only)
- T198584; FLIR Tools
- T198583; FLIR Tools+ (download card incl. license key)
- DSW-10000; FLIR IR Camera Player
- APP-10002; FLIR Tools Mobile (Android Application)
- T198697; FLIR ResearchIR Max + HSDR 4 (hardware sec. dev.)
- T199014; FLIR ResearchIR Max + HSDR 4 (printed license key)
- T199044; FLIR ResearchIR Max + HSDR 4 Upgrade (printed license key)
- T198696; FLIR ResearchIR Max 4 (hardware sec. dev.)
- T199013; FLIR ResearchIR Max 4 (printed license key)
- T199043; FLIR ResearchIR Max 4 Upgrade (printed license key)
- T198731; FLIR ResearchIR Standard 4 (hardware sec. dev.)
- T199012; FLIR ResearchIR Standard 4 (printed license key)
- T199042; FLIR ResearchIR Standard 4 Upgrade (printed license key)
- T199233; FLIR Atlas SDK for .NET
- T199234; FLIR Atlas SDK for MATLAB
- T198567; ThermoVision™ System Developers Kit Ver. 2.6
- T198566; ThermoVision™ LabVIEW® Digital Toolkit Ver. 3.3

22.20 FLIR GF320 14.5°

P/N: 44401-0101

Rev.: 45202

General description	
<p>The FLIR GF320 is an infrared camera for optical gas imaging (OGI) that visualizes and pinpoints leaks of methane and other volatile organic compounds (VOCs), without the need to shut down the operation. The portable camera also greatly improves operator safety, by detecting emissions at a safe distance, and helps to protect the environment by tracing leaks of environmentally harmful gases.</p> <p>The FLIR GF320 is used in industrial settings such as oil refineries, natural gas processing plants, off-shore platforms, chemical/petrochemical industries, and biogas and power generation plants.</p>	
Benefits:	
<ul style="list-style-type: none"> • Improved efficiency: The FLIR GF320 reduces revenue loss by pinpointing even small gas leaks quickly and efficiently, and from a distance. It also reduces the inspection time by allowing a broad area to be scanned rapidly and without the need to interrupt the industrial process. The wireless connectivity of the camera allows you to connect to smart phones or tablets for the wireless transfer of images or remote control of the camera. The FLIR GF320 is also used for temperature measurement, which makes it even more useful for predictive maintenance. • Increased worker safety: OGI allows gas leaks to be detected in a non-contact mode and from a safe distance. This reduces the risk of the user being exposed to invisible and potentially harmful or explosive chemicals. With a FLIR GF320 gas imaging camera it is easy to scan areas of interest that are difficult to reach with conventional methods. The camera is ergonomically designed, with a bright LCD and tiltable viewfinder, which facilitates its use over a full working day. • Protecting the environment: Several VOCs are dangerous to human health or cause harm to the environment, and are usually governed by regulations. Even small leaks can be detected and documented using the FLIR GF320 camera. 	
<p>Detects the following gases: benzene, ethanol, ethylbenzene, heptane, hexane, isoprene, methanol, MEK, MIBK, octane, pentane, 1-pentene, toluene, xylene, butane, ethane, methane, propane, ethylene, propylene.</p>	
Licensing and classification	
License information	Interchangeable lens version of the FLIR GF3XX series requires US Department of State License and will be subject to limitations on resale, except inside US. Allow a minimum of 90 days after application submittal for approval.
Imaging and optical data	
IR resolution	320 × 240 pixels
Thermal sensitivity/NETD	<15 mK @ +30°C (+86°F)
Field of view (FOV)	14.5° × 10.8°
Minimum focus distance	0.5 m (1.64 ft.)
Focal length	38 mm (1.49 in.)
Lens identification	Automatic
F-number	1.5
Focus	Automatic (one touch) or manual (electric or on the lens)
Zoom	1–8× continuous, digital zoom
Digital image enhancement	Noise reduction filter, high sensitivity mode (HSM)

Detector data	
Detector type	Focal plane array (FPA), cooled InSb
Spectral range	3.2–3.4 μm
Detector pitch	30 μm
Sensor cooling	Stirling Microcooler (FLIR MC-3)
Detects following gases	Benzene, Ethanol, Ethylbenzene, Heptane, Hexane, Isoprene, Methanol, MEK, MIBK, Octane, Pentane, 1-Pentene, Toluene, Xylene, Butane, Ethane, Methane, Propane, Ethylene, Propylene
Electronics and data rate	
Full frame rate	60 Hz
Image presentation	
Display	Built-in widescreen, 4.3 in. LCD, 800 × 480 pixels
Viewfinder	Built-in, tiltable OLED, 800 × 480 pixels
Automatic image adjustment	Continuous/manual; linear or histogram based
Manual image adjustment	Level/span
Image presentation modes	
Image modes	IR image, visual image, high sensitivity mode (HSM)
Measurement	
Temperature range	-20°C to +350°C (-4°F to +662°F)
Accuracy	$\pm 1^\circ\text{C}$ ($\pm 1.8^\circ\text{F}$) for temperature range (0°C, to +100°C, +32°F to +212°F) or $\pm 2\%$ of reading for temperature range (>+100°C, >+212°F)
Measurement analysis	
Spotmeter	10
Area	5 boxes with max./min./average
Profile	1 live line (horizontal or vertical)
Difference temperature	Delta temperature between measurement functions or reference temperature
Reference temperature	Manually set or captured from any measurement function
Emissivity correction	Variable from 0.01 to 1.0 or selected from editable materials list
Reflected apparent temperature correction	Automatic, based on input of reflected temperature
Measurement corrections	Reflected temperature, distance, atmospheric transmission, humidity, external optics

Set-up	
Menu commands	Level, span Auto adjust continuous/manual/semi-automatic Zoom Palette Start/stop recording Store image Playback/recall image
Color palettes	Iron, Gray, Rainbow, Arctic, Lava, Rainbow HC
Set-up commands	1 programmable button, overlay recording mode, local adaptation of units, language, date and time formats
Storage of images	
Storage media	Removable SD or SDHC memory card , two card slots
Image storage capacity	> 1200 images (JPEG) with post process capability per GB on memory card
Image storage mode	IR/visual images Visual image can automatically be associated with corresponding IR image
Periodic image storage	Every 10 seconds up to 24 hours
File formats	Standard JPEG, 14 bit measurement data included
Geographic Information System	
GPS	Location data automatically added to every image from built-in GPS
Video recording in camera	
Radiometric IR video recording	*.seq video clips to memory card (7.5 and 15 Hz).
Non-radiometric IR video recording	MPEG4 (up to 60 minutes/clip) to memory card. Visual image can automatically be associated with corresponding recording of non-radiometric IR video.
Visual video recording	MPEG4 (25 minutes/clip) to memory card
Video streaming	
Radiometric IR video streaming	Full dynamic to PC using USB cable or to mobile devices using Wi-Fi. PC software capable of displaying the video stream include the following: <ul style="list-style-type: none"> • FLIR IR Camera Player • FLIR ResearchIR • FLIR Tools
Non-radiometric IR video streaming	RTP/MPEG4
Digital camera	
Built-in digital camera	3.2 Mpixels, auto focus, and two video lamps

Laser pointer	
Laser	Activated by dedicated button
Laser classification	Class 2
Laser type	Semiconductor AlGaInP diode laser, 1 mW, 635 nm (red)
USB	
USB	<ul style="list-style-type: none"> • USB-A: Connect external USB device • USB Mini-B: Data transfer to and from PC
USB, standard	USB Mini-B: 2.0 high speed
Composite video	
Video out	Digital video output (image)
Power system	
Battery type	Rechargeable Li ion battery
Battery voltage	7.2 V
Battery capacity	4.4 Ah
Battery operating time	> 3 hours at 25°C (+77°F) and typical use
Charging system	In camera (AC adapter or 12 V from a vehicle) or 2-bay charger
Charging time	2.5 h to 95% capacity, charging status indicated by LED's
External power operation	AC adapter 90–260 VAC, 50/60 Hz or 12 V from a vehicle (cable with standard plug, optional)
DC operation	10.8 to 16 V DC, polarity protected (proprietary protected)
Power	8.5 W typically
Start-up time	Typically 7 min. @ 25°C (+77°F)
Environmental data	
Operating temperature range	–20°C to +50°C (–4°F to +122°F)
Storage temperature range	–30°C to +60°C (–22°F to +140°F)
Humidity (operating and storage)	IEC 68-2-30/24 h 95% relative humidity +25°C to +40°C (+77°F to +104°F) (2 cycles)
Directives	<ul style="list-style-type: none"> • 73/23EEC • 2004/108/EC • 2002/95/EC • 2002/96/EC
EMC	<ul style="list-style-type: none"> • EN61000-6-4 (Emission) • EN61000-6-2 (Immunity) • FCC 47 CFR Part 15 class A (Emission) • EN 61 000-4-8, L5
Encapsulation	IP 54 (IEC 60529)
Shock	25 g (IEC 60068-2-27)
Vibration	2 g (IEC 60068-2-6)
Safety	Power supply: EN/UL/IEC 60950-1

Physical data	
Camera weight, excl. lens and battery	1.94 kg (4.27 lb.)
Camera weight, incl. lens and excl. battery	2.24 kg (4.94 lb.)
Camera weight, incl. lens and battery	2.48 kg (5.47 lb.)
Battery weight	0.24 kg (0.52 lb.)
Camera size, excl. lens (L × W × H)	284 × 169 × 161 mm (11.2 × 6.7 × 6.3 in.)
Cameras size, incl. lens (L × W × H)	305 × 169 × 161 mm (12.0 × 6.7 × 6.3 in.)
Battery size (L × W × H)	141 × 47 × 28 mm (5.5 × 1.8 × 1.1 in.)
Battery charger size (L × W × H)	158 × 122 × 25 mm (6.2 × 4.8 × 1.0 in.)
Tripod mounting	UNC ¼"-20
Housing material	Aluminum, magnesium
Grip material	TPE thermoplastic elastomers
Shipping information	
Packaging, type	Cardboard box
List of contents	<ul style="list-style-type: none"> • Infrared camera with lens • Battery charger • Battery, 2 ea. • Hard transport case • HDMI-DVI cable • HDMI-HDMI cable • Lens cap (2 ea.) • Lens cap (mounted on lens) • Memory card • Power supply, incl. multi-plugs • Printed documentation • Shoulder strap • USB cable • Wi-Fi USB micro adapter (depending on CE and FCC regulations regarding wireless equipment for your country)
Packaging, weight	
Packaging, size	400 × 190 × 510 mm (15.7 × 7.5 × 20.1 in.)

Supplies & accessories:

- T197387; IR lens, 24° with case for GF300, GF309, GF320
- T197388; IR lens, 6° with case for GF300, GF309, GF320, GF346.
- T197385; IR lens, 14.5° with case for GF300, GF309, GF320
- T197692; Battery charger, incl. power supply with multi plugs
- T910814; Power supply, incl. multi plugs
- T198511; Li-Ion Battery pack 7.4V 33Wh
- T199367ACC; Battery Li-ion 7.2 V, 4.4 Ah, 32 Wh
- T911650ACC; Memory card SD Card 8 GB
- 1910423; USB cable Std A <-> Mini-B
- T198509; Cigarette lighter adapter kit, 12 VDC, 1.2 m/3.9 ft.
- T910815ACC; HDMI to HDMI cable 1.5 m
- T910816ACC; HDMI to DVI cable 1.5 m
- T197555; Hard transport case for FLIR GF3xx-Series
- T951387; Wi-Fi USB micro adapter
- T198586; FLIR Reporter Professional (license only)
- T198584; FLIR Tools

-
- T198583; FLIR Tools+ (download card incl. license key)
 - T198585; FLIR VideoReport
 - DSW-10000; FLIR IR Camera Player
 - APP-10002; FLIR Tools Mobile (Android Application)
 - T198697; FLIR ResearchIR Max + HSDR 4 (hardware sec. dev.)
 - T199014; FLIR ResearchIR Max + HSDR 4 (printed license key)
 - T199044; FLIR ResearchIR Max + HSDR 4 Upgrade (printed license key)
 - T198696; FLIR ResearchIR Max 4 (hardware sec. dev.)
 - T199013; FLIR ResearchIR Max 4 (printed license key)
 - T199043; FLIR ResearchIR Max 4 Upgrade (printed license key)
 - T198731; FLIR ResearchIR Standard 4 (hardware sec. dev.)
 - T199012; FLIR ResearchIR Standard 4 (printed license key)
 - T199042; FLIR ResearchIR Standard 4 Upgrade (printed license key)
 - T199233; FLIR Atlas SDK for .NET
 - T199234; FLIR Atlas SDK for MATLAB
 - T198567; ThermoVision™ System Developers Kit Ver. 2.6
 - T198566; ThermoVision™ LabVIEW® Digital Toolkit Ver. 3.3

22.21 FLIR GF320 14.5° Fixed lens

P/N: 44402-0101

Rev.: 45202

General description	
<p>The FLIR GF320 is an infrared camera for optical gas imaging (OGI) that visualizes and pinpoints leaks of methane and other volatile organic compounds (VOCs), without the need to shut down the operation. The portable camera also greatly improves operator safety, by detecting emissions at a safe distance, and helps to protect the environment by tracing leaks of environmentally harmful gases.</p> <p>The FLIR GF320 is used in industrial settings such as oil refineries, natural gas processing plants, off-shore platforms, chemical/petrochemical industries, and biogas and power generation plants.</p>	
Benefits:	
<ul style="list-style-type: none"> Improved efficiency: The FLIR GF320 reduces revenue loss by pinpointing even small gas leaks quickly and efficiently, and from a distance. It also reduces the inspection time by allowing a broad area to be scanned rapidly and without the need to interrupt the industrial process. The wireless connectivity of the camera allows you to connect to smart phones or tablets for the wireless transfer of images or remote control of the camera. The FLIR GF320 is also used for temperature measurement, which makes it even more useful for predictive maintenance. Increased worker safety: OGI allows gas leaks to be detected in a non-contact mode and from a safe distance. This reduces the risk of the user being exposed to invisible and potentially harmful or explosive chemicals. With a FLIR GF320 gas imaging camera it is easy to scan areas of interest that are difficult to reach with conventional methods. The camera is ergonomically designed, with a bright LCD and tiltable viewfinder, which facilitates its use over a full working day. Protecting the environment: Several VOCs are dangerous to human health or cause harm to the environment, and are usually governed by regulations. Even small leaks can be detected and documented using the FLIR GF320 camera. 	
<p>Detects the following gases: benzene, ethanol, ethylbenzene, heptane, hexane, isoprene, methanol, MEK, MIBK, octane, pentane, 1-pentene, toluene, xylene, butane, ethane, methane, propane, ethylene, propylene.</p>	
Imaging and optical data	
IR resolution	320 × 240 pixels
Thermal sensitivity/NETD	<15 mK @ +30°C (+86°F)
Field of view (FOV)	14.5° × 10.8°
Minimum focus distance	0.5 m (1.64 ft.)
Focal length	38 mm (1.49 in.)
Lens identification	Automatic
F-number	1.5
Focus	Automatic (one touch) or manual (electric or on the lens)
Zoom	1–8x continuous, digital zoom
Digital image enhancement	Noise reduction filter, high sensitivity mode (HSM)
Detector data	
Detector type	Focal plane array (FPA), cooled InSb
Spectral range	3.2–3.4 μm
Detector pitch	30 μm

Detector data	
Sensor cooling	Stirling Microcooler (FLIR MC-3)
Detects following gases	Benzene, Ethanol, Ethylbenzene, Heptane, Hexane, Isoprene, Methanol, MEK, MIBK, Octane, Pentane, 1-Pentene, Toluene, Xylene, Butane, Ethane, Methane, Propane, Ethylene, Propylene
Electronics and data rate	
Full frame rate	60 Hz
Image presentation	
Display	Built-in widescreen, 4.3 in. LCD, 800 × 480 pixels
Viewfinder	Built-in, tiltable OLED, 800 × 480 pixels
Automatic image adjustment	Continuous/manual; linear or histogram based
Manual image adjustment	Level/span
Image presentation modes	
Image modes	IR image, visual image, high sensitivity mode (HSM)
Measurement	
Temperature range	-20°C to +350°C (-4°F to +662°F)
Accuracy	±1°C (±1.8°F) for temperature range (0°C, to +100°C, +32°F to +212°F) or ±2% of reading for temperature range (>+100°C, >+212°F)
Measurement analysis	
Spotmeter	10
Area	5 boxes with max./min./average
Profile	1 live line (horizontal or vertical)
Difference temperature	Delta temperature between measurement functions or reference temperature
Reference temperature	Manually set or captured from any measurement function
Emissivity correction	Variable from 0.01 to 1.0 or selected from editable materials list
Reflected apparent temperature correction	Automatic, based on input of reflected temperature
Measurement corrections	Reflected temperature, distance, atmospheric transmission, humidity, external optics

Set-up	
Menu commands	Level, span Auto adjust continuous/manual/semi-automatic Zoom Palette Start/stop recording Store image Playback/recall image
Color palettes	Iron, Gray, Rainbow, Arctic, Lava, Rainbow HC
Set-up commands	1 programmable button, overlay recording mode, local adaptation of units, language, date and time formats
Storage of images	
Storage media	Removable SD or SDHC memory card , two card slots
Image storage capacity	> 1200 images (JPEG) with post process capability per GB on memory card
Image storage mode	IR/visual images Visual image can automatically be associated with corresponding IR image
Periodic image storage	Every 10 seconds up to 24 hours
File formats	Standard JPEG, 14 bit measurement data included
Geographic Information System	
GPS	Location data automatically added to every image from built-in GPS
Video recording in camera	
Radiometric IR video recording	*.seq video clips to memory card (7.5 and 15 Hz).
Non-radiometric IR video recording	MPEG4 (up to 60 minutes/clip) to memory card. Visual image can automatically be associated with corresponding recording of non-radiometric IR video.
Visual video recording	MPEG4 (25 minutes/clip) to memory card
Video streaming	
Radiometric IR video streaming	Full dynamic to PC using USB cable or to mobile devices using Wi-Fi. PC software capable of displaying the video stream include the following: <ul style="list-style-type: none"> • FLIR IR Camera Player • FLIR ResearchIR • FLIR Tools
Non-radiometric IR video streaming	RTP/MPEG4
Digital camera	
Built-in digital camera	3.2 Mpixels, auto focus, and two video lamps

Laser pointer	
Laser	Activated by dedicated button
Laser classification	Class 2
Laser type	Semiconductor AlGaInP diode laser, 1 mW, 635 nm (red)
USB	
USB	<ul style="list-style-type: none"> • USB-A: Connect external USB device • USB Mini-B: Data transfer to and from PC
USB, standard	USB Mini-B: 2.0 high speed
Composite video	
Video out	Digital video output (image)
Power system	
Battery type	Rechargeable Li ion battery
Battery voltage	7.2 V
Battery capacity	4.4 Ah
Battery operating time	> 3 hours at 25°C (+77°F) and typical use
Charging system	In camera (AC adapter or 12 V from a vehicle) or 2-bay charger
Charging time	2.5 h to 95% capacity, charging status indicated by LED's
External power operation	AC adapter 90–260 VAC, 50/60 Hz or 12 V from a vehicle (cable with standard plug, optional)
DC operation	10.8 to 16 V DC, polarity protected (proprietary protected)
Power	8.5 W typically
Start-up time	Typically 7 min. @ 25°C (+77°F)
Environmental data	
Operating temperature range	–20°C to +50°C (–4°F to +122°F)
Storage temperature range	–30°C to +60°C (–22°F to +140°F)
Humidity (operating and storage)	IEC 68-2-30/24 h 95% relative humidity +25°C to +40°C (+77°F to +104°F) (2 cycles)
Directives	<ul style="list-style-type: none"> • 73/23EEC • 2004/108/EC • 2002/95/EC • 2002/96/EC
EMC	<ul style="list-style-type: none"> • EN61000-6-4 (Emission) • EN61000-6-2 (Immunity) • FCC 47 CFR Part 15 class A (Emission) • EN 61 000-4-8, L5
Encapsulation	IP 54 (IEC 60529)
Shock	25 g (IEC 60068-2-27)
Vibration	2 g (IEC 60068-2-6)
Safety	Power supply: EN/UL/IEC 60950-1

Physical data	
Camera weight, excl. lens and battery	1.94 kg (4.27 lb.)
Camera weight, incl. lens and excl. battery	2.24 kg (4.94 lb.)
Camera weight, incl. lens and battery	2.48 kg (5.47 lb.)
Battery weight	0.24 kg (0.52 lb.)
Camera size, excl. lens (L × W × H)	284 × 169 × 161 mm (11.2 × 6.7 × 6.3 in.)
Cameras size, incl. lens (L × W × H)	305 × 169 × 161 mm (12.0 × 6.7 × 6.3 in.)
Battery size (L × W × H)	141 × 47 × 28 mm (5.5 × 1.8 × 1.1 in.)
Battery charger size (L × W × H)	158 × 122 × 25 mm (6.2 × 4.8 × 1.0 in.)
Tripod mounting	UNC ¼"-20
Housing material	Aluminum, magnesium
Grip material	TPE thermoplastic elastomers
Shipping information	
Packaging, type	Cardboard box
List of contents	<ul style="list-style-type: none"> • Infrared camera with lens • Battery charger • Battery, 2 ea. • Hard transport case • HDMI-DVI cable • HDMI-HDMI cable • Lens cap (mounted on lens) • Memory card • Power supply, incl. multi-plugs • Printed documentation • Shoulder strap • USB cable • Wi-Fi USB micro adapter (depending on CE and FCC regulations regarding wireless equipment for your country)
Packaging, weight	
Packaging, size	400 × 190 × 510 mm (15.7 × 7.5 × 20.1 in.)

Supplies & accessories:

- T197692; Battery charger, incl. power supply with multi plugs
- T910814; Power supply, incl. multi plugs
- T198511; Li-Ion Battery pack 7.4V 33Wh
- T199367ACC; Battery Li-ion 7.2 V, 4.4 Ah, 32 Wh
- T911650ACC; Memory card SD Card 8 GB
- 1910423; USB cable Std A <-> Mini-B
- T198509; Cigarette lighter adapter kit, 12 VDC, 1.2 m/3.9 ft.
- T910815ACC; HDMI to HDMI cable 1.5 m
- T910816ACC; HDMI to DVI cable 1.5 m
- T197555; Hard transport case for FLIR GF3xx-Series
- T951387; Wi-Fi USB micro adapter
- T198586; FLIR Reporter Professional (license only)
- T198584; FLIR Tools
- T198583; FLIR Tools+ (download card incl. license key)
- T198585; FLIR VideoReport
- DSW-10000; FLIR IR Camera Player
- APP-10002; FLIR Tools Mobile (Android Application)

- T198697; FLIR ResearchIR Max + HSDR 4 (hardware sec. dev.)
- T199014; FLIR ResearchIR Max + HSDR 4 (printed license key)
- T199044; FLIR ResearchIR Max + HSDR 4 Upgrade (printed license key)
- T198696; FLIR ResearchIR Max 4 (hardware sec. dev.)
- T199013; FLIR ResearchIR Max 4 (printed license key)
- T199043; FLIR ResearchIR Max 4 Upgrade (printed license key)
- T198731; FLIR ResearchIR Standard 4 (hardware sec. dev.)
- T199012; FLIR ResearchIR Standard 4 (printed license key)
- T199042; FLIR ResearchIR Standard 4 Upgrade (printed license key)
- T199233; FLIR Atlas SDK for .NET
- T199234; FLIR Atlas SDK for MATLAB
- T198567; ThermoVision™ System Developers Kit Ver. 2.6
- T198566; ThermoVision™ LabVIEW® Digital Toolkit Ver. 3.3

22.22 FLIR GF320 24°

P/N: 44401-0102

Rev.: 45204

General description	
<p>The FLIR GF320 is an infrared camera for optical gas imaging (OGI) that visualizes and pinpoints leaks of methane and other volatile organic compounds (VOCs), without the need to shut down the operation. The portable camera also greatly improves operator safety, by detecting emissions at a safe distance, and helps to protect the environment by tracing leaks of environmentally harmful gases.</p> <p>The FLIR GF320 is used in industrial settings such as oil refineries, natural gas processing plants, off-shore platforms, chemical/petrochemical industries, and biogas and power generation plants.</p>	
Benefits:	
<ul style="list-style-type: none"> Improved efficiency: The FLIR GF320 reduces revenue loss by pinpointing even small gas leaks quickly and efficiently, and from a distance. It also reduces the inspection time by allowing a broad area to be scanned rapidly and without the need to interrupt the industrial process. The wireless connectivity of the camera allows you to connect to smart phones or tablets for the wireless transfer of images or remote control of the camera. The FLIR GF320 is also used for temperature measurement, which makes it even more useful for predictive maintenance. Increased worker safety: OGI allows gas leaks to be detected in a non-contact mode and from a safe distance. This reduces the risk of the user being exposed to invisible and potentially harmful or explosive chemicals. With a FLIR GF320 gas imaging camera it is easy to scan areas of interest that are difficult to reach with conventional methods. The camera is ergonomically designed, with a bright LCD and tiltable viewfinder, which facilitates its use over a full working day. Protecting the environment: Several VOCs are dangerous to human health or cause harm to the environment, and are usually governed by regulations. Even small leaks can be detected and documented using the FLIR GF320 camera. 	
<p>Detects the following gases: benzene, ethanol, ethylbenzene, heptane, hexane, isoprene, methanol, MEK, MIBK, octane, pentane, 1-pentene, toluene, xylene, butane, ethane, methane, propane, ethylene, propylene.</p>	
Licensing and classification	
License information	Interchangeable lens version of the FLIR GF3XX series requires US Department of State License and will be subject to limitations on resale, except inside US. Allow a minimum of 90 days after application submittal for approval.
Imaging and optical data	
IR resolution	320 × 240 pixels
Thermal sensitivity/NETD	<15 mK @ +30°C (+86°F)
Field of view (FOV)	24° × 18°
Minimum focus distance	0.3 m (1.0 ft.)
Focal length	23 mm (0.89 in.)
Lens identification	Automatic
F-number	1.5
Focus	Automatic (one touch) or manual (electric or on the lens)
Zoom	1–8× continuous, digital zoom
Digital image enhancement	Noise reduction filter, high sensitivity mode (HSM)

Detector data	
Detector type	Focal plane array (FPA), cooled InSb
Spectral range	3.2–3.4 μm
Detector pitch	30 μm
Sensor cooling	Stirling Microcooler (FLIR MC-3)
Detects following gases	Benzene, Ethanol, Ethylbenzene, Heptane, Hexane, Isoprene, Methanol, MEK, MIBK, Octane, Pentane, 1-Pentene, Toluene, Xylene, Butane, Ethane, Methane, Propane, Ethylene, Propylene
Electronics and data rate	
Full frame rate	60 Hz
Image presentation	
Display	Built-in widescreen, 4.3 in. LCD, 800 × 480 pixels
Viewfinder	Built-in, tiltable OLED, 800 × 480 pixels
Automatic image adjustment	Continuous/manual; linear or histogram based
Manual image adjustment	Level/span
Image presentation modes	
Image modes	IR image, visual image, high sensitivity mode (HSM)
Measurement	
Temperature range	-20°C to +350°C (-4°F to +662°F)
Accuracy	$\pm 1^\circ\text{C}$ ($\pm 1.8^\circ\text{F}$) for temperature range (0°C, to +100°C, +32°F to +212°F) or $\pm 2\%$ of reading for temperature range (>+100°C, >+212°F)
Measurement analysis	
Spotmeter	10
Area	5 boxes with max./min./average
Profile	1 live line (horizontal or vertical)
Difference temperature	Delta temperature between measurement functions or reference temperature
Reference temperature	Manually set or captured from any measurement function
Emissivity correction	Variable from 0.01 to 1.0 or selected from editable materials list
Reflected apparent temperature correction	Automatic, based on input of reflected temperature
Measurement corrections	Reflected temperature, distance, atmospheric transmission, humidity, external optics

Set-up	
Menu commands	Level, span Auto adjust continuous/manual/semi-automatic Zoom Palette Start/stop recording Store image Playback/recall image
Color palettes	Iron, Gray, Rainbow, Arctic, Lava, Rainbow HC
Set-up commands	1 programmable button, overlay recording mode, local adaptation of units, language, date and time formats
Storage of images	
Storage media	Removable SD or SDHC memory card , two card slots
Image storage capacity	> 1200 images (JPEG) with post process capability per GB on memory card
Image storage mode	IR/visual images Visual image can automatically be associated with corresponding IR image
Periodic image storage	Every 10 seconds up to 24 hours
File formats	Standard JPEG, 14 bit measurement data included
Geographic Information System	
GPS	Location data automatically added to every image from built-in GPS
Video recording in camera	
Radiometric IR video recording	*.seq video clips to memory card (7.5 and 15 Hz).
Non-radiometric IR video recording	MPEG4 (up to 60 minutes/clip) to memory card. Visual image can automatically be associated with corresponding recording of non-radiometric IR video.
Visual video recording	MPEG4 (25 minutes/clip) to memory card
Video streaming	
Radiometric IR video streaming	Full dynamic to PC using USB cable or to mobile devices using Wi-Fi. PC software capable of displaying the video stream include the following: <ul style="list-style-type: none"> • FLIR IR Camera Player • FLIR ResearchIR • FLIR Tools
Non-radiometric IR video streaming	RTP/MPEG4
Digital camera	
Built-in digital camera	3.2 Mpixels, auto focus, and two video lamps

Laser pointer	
Laser	Activated by dedicated button
Laser classification	Class 2
Laser type	Semiconductor AlGaInP diode laser, 1 mW, 635 nm (red)
USB	
USB	<ul style="list-style-type: none"> • USB-A: Connect external USB device • USB Mini-B: Data transfer to and from PC
USB, standard	USB Mini-B: 2.0 high speed
Composite video	
Video out	Digital video output (image)
Power system	
Battery type	Rechargeable Li ion battery
Battery voltage	7.2 V
Battery capacity	4.4 Ah
Battery operating time	> 3 hours at 25°C (+77°F) and typical use
Charging system	In camera (AC adapter or 12 V from a vehicle) or 2-bay charger
Charging time	2.5 h to 95% capacity, charging status indicated by LED's
External power operation	AC adapter 90–260 VAC, 50/60 Hz or 12 V from a vehicle (cable with standard plug, optional)
DC operation	10.8 to 16 V DC, polarity protected (proprietary protected)
Power	8.5 W typically
Start-up time	Typically 7 min. @ 25°C (+77°F)
Environmental data	
Operating temperature range	–20°C to +50°C (–4°F to +122°F)
Storage temperature range	–30°C to +60°C (–22°F to +140°F)
Humidity (operating and storage)	IEC 68-2-30/24 h 95% relative humidity +25°C to +40°C (+77°F to +104°F) (2 cycles)
Directives	<ul style="list-style-type: none"> • 73/23EEC • 2004/108/EC • 2002/95/EC • 2002/96/EC
EMC	<ul style="list-style-type: none"> • EN61000-6-4 (Emission) • EN61000-6-2 (Immunity) • FCC 47 CFR Part 15 class A (Emission) • EN 61 000-4-8, L5
Encapsulation	IP 54 (IEC 60529)
Shock	25 g (IEC 60068-2-27)
Vibration	2 g (IEC 60068-2-6)
Safety	Power supply: EN/UL/IEC 60950-1

Physical data	
Camera weight, excl. lens and battery	1.94 kg (4.27 lb.)
Camera weight, incl. lens and excl. battery	2.24 kg (4.94 lb.)
Camera weight, incl. lens and battery	2.48 kg (5.47 lb.)
Battery weight	0.24 kg (0.52 lb.)
Camera size, excl. lens (L × W × H)	284 × 169 × 161 mm (11.2 × 6.7 × 6.3 in.)
Cameras size, incl. lens (L × W × H)	306 × 169 × 161 mm (12.0 × 6.7 × 6.3 in.)
Battery size (L × W × H)	141 × 47 × 28 mm (5.5 × 1.8 × 1.1 in.)
Battery charger size (L × W × H)	158 × 122 × 25 mm (6.2 × 4.8 × 1.0 in.)
Tripod mounting	UNC ¼"-20
Housing material	Aluminum, magnesium
Grip material	TPE thermoplastic elastomers
Shipping information	
Packaging, type	Cardboard box
List of contents	<ul style="list-style-type: none"> • Infrared camera with lens • Battery charger • Battery, 2 ea. • Hard transport case • HDMI-DVI cable • HDMI-HDMI cable • Lens cap (2 ea.) • Lens cap (mounted on lens) • Memory card • Power supply, incl. multi-plugs • Printed documentation • Shoulder strap • USB cable • Wi-Fi USB micro adapter (depending on CE and FCC regulations regarding wireless equipment for your country)
Packaging, weight	
Packaging, size	400 × 190 × 510 mm (15.7 × 7.5 × 20.1 in.)

Supplies & accessories:

- T197387; IR lens, 24° with case for GF300, GF309, GF320
- T197388; IR lens, 6° with case for GF300, GF309, GF320, GF346.
- T197385; IR lens, 14.5° with case for GF300, GF309, GF320
- T197692; Battery charger, incl. power supply with multi plugs
- T910814; Power supply, incl. multi plugs
- T198511; Li-Ion Battery pack 7.4V 33Wh
- T199367ACC; Battery Li-ion 7.2 V, 4.4 Ah, 32 Wh
- T911650ACC; Memory card SD Card 8 GB
- 1910423; USB cable Std A <-> Mini-B
- T198509; Cigarette lighter adapter kit, 12 VDC, 1.2 m/3.9 ft.
- T910815ACC; HDMI to HDMI cable 1.5 m
- T910816ACC; HDMI to DVI cable 1.5 m
- T197555; Hard transport case for FLIR GF3xx-Series
- T951387; Wi-Fi USB micro adapter
- T198586; FLIR Reporter Professional (license only)
- T198584; FLIR Tools

-
- T198583; FLIR Tools+ (download card incl. license key)
 - T198585; FLIR VideoReport
 - DSW-10000; FLIR IR Camera Player
 - APP-10002; FLIR Tools Mobile (Android Application)
 - T198697; FLIR ResearchIR Max + HSDR 4 (hardware sec. dev.)
 - T199014; FLIR ResearchIR Max + HSDR 4 (printed license key)
 - T199044; FLIR ResearchIR Max + HSDR 4 Upgrade (printed license key)
 - T198696; FLIR ResearchIR Max 4 (hardware sec. dev.)
 - T199013; FLIR ResearchIR Max 4 (printed license key)
 - T199043; FLIR ResearchIR Max 4 Upgrade (printed license key)
 - T198731; FLIR ResearchIR Standard 4 (hardware sec. dev.)
 - T199012; FLIR ResearchIR Standard 4 (printed license key)
 - T199042; FLIR ResearchIR Standard 4 Upgrade (printed license key)
 - T199233; FLIR Atlas SDK for .NET
 - T199234; FLIR Atlas SDK for MATLAB
 - T198567; ThermoVision™ System Developers Kit Ver. 2.6
 - T198566; ThermoVision™ LabVIEW® Digital Toolkit Ver. 3.3

22.23 FLIR GF320 24° Fixed lens

P/N: 44402-0102

Rev.: 45202

General description	
<p>The FLIR GF320 is an infrared camera for optical gas imaging (OGI) that visualizes and pinpoints leaks of methane and other volatile organic compounds (VOCs), without the need to shut down the operation. The portable camera also greatly improves operator safety, by detecting emissions at a safe distance, and helps to protect the environment by tracing leaks of environmentally harmful gases.</p> <p>The FLIR GF320 is used in industrial settings such as oil refineries, natural gas processing plants, off-shore platforms, chemical/petrochemical industries, and biogas and power generation plants.</p>	
Benefits:	
<ul style="list-style-type: none"> • Improved efficiency: The FLIR GF320 reduces revenue loss by pinpointing even small gas leaks quickly and efficiently, and from a distance. It also reduces the inspection time by allowing a broad area to be scanned rapidly and without the need to interrupt the industrial process. The wireless connectivity of the camera allows you to connect to smart phones or tablets for the wireless transfer of images or remote control of the camera. The FLIR GF320 is also used for temperature measurement, which makes it even more useful for predictive maintenance. • Increased worker safety: OGI allows gas leaks to be detected in a non-contact mode and from a safe distance. This reduces the risk of the user being exposed to invisible and potentially harmful or explosive chemicals. With a FLIR GF320 gas imaging camera it is easy to scan areas of interest that are difficult to reach with conventional methods. The camera is ergonomically designed, with a bright LCD and tiltable viewfinder, which facilitates its use over a full working day. • Protecting the environment: Several VOCs are dangerous to human health or cause harm to the environment, and are usually governed by regulations. Even small leaks can be detected and documented using the FLIR GF320 camera. 	
<p>Detects the following gases: benzene, ethanol, ethylbenzene, heptane, hexane, isoprene, methanol, MEK, MIBK, octane, pentane, 1-pentene, toluene, xylene, butane, ethane, methane, propane, ethylene, propylene.</p>	
Imaging and optical data	
IR resolution	320 × 240 pixels
Thermal sensitivity/NETD	<15 mK @ +30°C (+86°F)
Field of view (FOV)	24° × 18°
Minimum focus distance	0.3 m (1.0 ft.)
Focal length	23 mm (0.89 in.)
Lens identification	Automatic
F-number	1.5
Focus	Automatic (one touch) or manual (electric or on the lens)
Zoom	1–8x continuous, digital zoom
Digital image enhancement	Noise reduction filter, high sensitivity mode (HSM)
Detector data	
Detector type	Focal plane array (FPA), cooled InSb
Spectral range	3.2–3.4 μm
Detector pitch	30 μm

Detector data	
Sensor cooling	Stirling Microcooler (FLIR MC-3)
Detects following gases	Benzene, Ethanol, Ethylbenzene, Heptane, Hexane, Isoprene, Methanol, MEK, MIBK, Octane, Pentane, 1-Pentene, Toluene, Xylene, Butane, Ethane, Methane, Propane, Ethylene, Propylene
Electronics and data rate	
Full frame rate	60 Hz
Image presentation	
Display	Built-in widescreen, 4.3 in. LCD, 800 × 480 pixels
Viewfinder	Built-in, tiltable OLED, 800 × 480 pixels
Automatic image adjustment	Continuous/manual; linear or histogram based
Manual image adjustment	Level/span
Image presentation modes	
Image modes	IR image, visual image, high sensitivity mode (HSM)
Measurement	
Temperature range	-20°C to +350°C (-4°F to +662°F)
Accuracy	±1°C (±1.8°F) for temperature range (0°C, to +100°C, +32°F to +212°F) or ±2% of reading for temperature range (>+100°C, >+212°F)
Measurement analysis	
Spotmeter	10
Area	5 boxes with max./min./average
Profile	1 live line (horizontal or vertical)
Difference temperature	Delta temperature between measurement functions or reference temperature
Reference temperature	Manually set or captured from any measurement function
Emissivity correction	Variable from 0.01 to 1.0 or selected from editable materials list
Reflected apparent temperature correction	Automatic, based on input of reflected temperature
Measurement corrections	Reflected temperature, distance, atmospheric transmission, humidity, external optics

Set-up	
Menu commands	Level, span Auto adjust continuous/manual/semi-automatic Zoom Palette Start/stop recording Store image Playback/recall image
Color palettes	Iron, Gray, Rainbow, Arctic, Lava, Rainbow HC
Set-up commands	1 programmable button, overlay recording mode, local adaptation of units, language, date and time formats
Storage of images	
Storage media	Removable SD or SDHC memory card , two card slots
Image storage capacity	> 1200 images (JPEG) with post process capability per GB on memory card
Image storage mode	IR/visual images Visual image can automatically be associated with corresponding IR image
Periodic image storage	Every 10 seconds up to 24 hours
File formats	Standard JPEG, 14 bit measurement data included
Geographic Information System	
GPS	Location data automatically added to every image from built-in GPS
Video recording in camera	
Radiometric IR video recording	*.seq video clips to memory card (7.5 and 15 Hz).
Non-radiometric IR video recording	MPEG4 (up to 60 minutes/clip) to memory card. Visual image can automatically be associated with corresponding recording of non-radiometric IR video.
Visual video recording	MPEG4 (25 minutes/clip) to memory card
Video streaming	
Radiometric IR video streaming	Full dynamic to PC using USB cable or to mobile devices using Wi-Fi. PC software capable of displaying the video stream include the following: <ul style="list-style-type: none"> • FLIR IR Camera Player • FLIR ResearchIR • FLIR Tools
Non-radiometric IR video streaming	RTP/MPEG4
Digital camera	
Built-in digital camera	3.2 Mpixels, auto focus, and two video lamps

Laser pointer	
Laser	Activated by dedicated button
Laser classification	Class 2
Laser type	Semiconductor AlGaInP diode laser, 1 mW, 635 nm (red)
USB	
USB	<ul style="list-style-type: none"> • USB-A: Connect external USB device • USB Mini-B: Data transfer to and from PC
USB, standard	USB Mini-B: 2.0 high speed
Composite video	
Video out	Digital video output (image)
Power system	
Battery type	Rechargeable Li ion battery
Battery voltage	7.2 V
Battery capacity	4.4 Ah
Battery operating time	> 3 hours at 25°C (+77°F) and typical use
Charging system	In camera (AC adapter or 12 V from a vehicle) or 2-bay charger
Charging time	2.5 h to 95% capacity, charging status indicated by LED's
External power operation	AC adapter 90–260 VAC, 50/60 Hz or 12 V from a vehicle (cable with standard plug, optional)
DC operation	10.8 to 16 V DC, polarity protected (proprietary protected)
Power	8.5 W typically
Start-up time	Typically 7 min. @ 25°C (+77°F)
Environmental data	
Operating temperature range	–20°C to +50°C (–4°F to +122°F)
Storage temperature range	–30°C to +60°C (–22°F to +140°F)
Humidity (operating and storage)	IEC 68-2-30/24 h 95% relative humidity +25°C to +40°C (+77°F to +104°F) (2 cycles)
Directives	<ul style="list-style-type: none"> • 73/23EEC • 2004/108/EC • 2002/95/EC • 2002/96/EC
EMC	<ul style="list-style-type: none"> • EN61000-6-4 (Emission) • EN61000-6-2 (Immunity) • FCC 47 CFR Part 15 class A (Emission) • EN 61 000-4-8, L5
Encapsulation	IP 54 (IEC 60529)
Shock	25 g (IEC 60068-2-27)
Vibration	2 g (IEC 60068-2-6)
Safety	Power supply: EN/UL/IEC 60950-1

Physical data	
Camera weight, excl. lens and battery	1.94 kg (4.27 lb.)
Camera weight, incl. lens and excl. battery	2.24 kg (4.94 lb.)
Camera weight, incl. lens and battery	2.48 kg (5.47 lb.)
Battery weight	0.24 kg (0.52 lb.)
Camera size, excl. lens (L x W x H)	284 x 169 x 161 mm (11.2 x 6.7 x 6.3 in.)
Cameras size, incl. lens (L x W x H)	306 x 169 x 161 mm (12.0 x 6.7 x 6.3 in.)
Battery size (L x W x H)	141 x 47 x 28 mm (5.5 x 1.8 x 1.1 in.)
Battery charger size (L x W x H)	158 x 122 x 25 mm (6.2 x 4.8 x 1.0 in.)
Tripod mounting	UNC ¼"-20
Housing material	Aluminum, magnesium
Grip material	TPE thermoplastic elastomers
Shipping information	
Packaging, type	Cardboard box
List of contents	<ul style="list-style-type: none"> • Infrared camera with lens • Battery charger • Battery, 2 ea. • Hard transport case • HDMI-DVI cable • HDMI-HDMI cable • Lens cap (mounted on lens) • Memory card • Power supply, incl. multi-plugs • Printed documentation • Shoulder strap • USB cable • Wi-Fi USB micro adapter (depending on CE and FCC regulations regarding wireless equipment for your country)
Packaging, weight	8.4 kg (18.5 lb.)
Packaging, size	400 x 190 x 510 mm (15.7 x 7.5 x 20.1 in.)

Supplies & accessories:

- T197692; Battery charger, incl. power supply with multi plugs
- T910814; Power supply, incl. multi plugs
- T198511; Li-Ion Battery pack 7.4V 33Wh
- T199367ACC; Battery Li-ion 7.2 V, 4.4 Ah, 32 Wh
- T911650ACC; Memory card SD Card 8 GB
- 1910423; USB cable Std A <-> Mini-B
- T198509; Cigarette lighter adapter kit, 12 VDC, 1.2 m/3.9 ft.
- T910815ACC; HDMI to HDMI cable 1.5 m
- T910816ACC; HDMI to DVI cable 1.5 m
- T197555; Hard transport case for FLIR GF3xx-Series
- T951387; Wi-Fi USB micro adapter
- T198586; FLIR Reporter Professional (license only)
- T198584; FLIR Tools
- T198583; FLIR Tools+ (download card incl. license key)
- T198585; FLIR VideoReport
- DSW-10000; FLIR IR Camera Player
- APP-10002; FLIR Tools Mobile (Android Application)

-
- T198697; FLIR ResearchIR Max + HSDR 4 (hardware sec. dev.)
 - T199014; FLIR ResearchIR Max + HSDR 4 (printed license key)
 - T199044; FLIR ResearchIR Max + HSDR 4 Upgrade (printed license key)
 - T198696; FLIR ResearchIR Max 4 (hardware sec. dev.)
 - T199013; FLIR ResearchIR Max 4 (printed license key)
 - T199043; FLIR ResearchIR Max 4 Upgrade (printed license key)
 - T198731; FLIR ResearchIR Standard 4 (hardware sec. dev.)
 - T199012; FLIR ResearchIR Standard 4 (printed license key)
 - T199042; FLIR ResearchIR Standard 4 Upgrade (printed license key)
 - T199233; FLIR Atlas SDK for .NET
 - T199234; FLIR Atlas SDK for MATLAB
 - T198567; ThermoVision™ System Developers Kit Ver. 2.6
 - T198566; ThermoVision™ LabVIEW® Digital Toolkit Ver. 3.3

22.24 FLIR GF335 24°

P/N: 57501-0102

Rev.: 45202

General description	
<p>The FLIR GF335 is a high-sensitivity, low-noise, cooled infrared camera for applications requiring a portable camera able to detect very subtle temperature differences. The high performance of the camera makes it perfect for the detection of faint heat signatures as well as for non-destructive testing and quality control applications.</p>	
Benefits:	
<ul style="list-style-type: none"> • High performance: The FLIR GF335 features a cooled 3–5 μm InSb detector that produces razor-sharp thermal images. Its high sensitivity of <15 mK and high accuracy of $\pm 1^\circ\text{C}$ ($\pm 1.8^\circ\text{F}$) or 1% allow the user to detect very subtle temperature differences with astounding clarity. • Improved efficiency: The wireless connectivity of the FLIR GF335 allows connection to smart phones and tablets for the wireless transfer of images or the remote control of the camera—a useful function if a second person is required to accompany the user. The camera also features built-in radiometric video recording, and can store MPEG-4 thermal and/or standard video on an SD card. The camera has integrated GPS and a digital camera, and is compatible with FLIR Tools, FLIR Reporter, and FLIR Researcher software. • Thought-through ergonomics for everyday use: The FLIR GF335 is ergonomically designed, with a bright LCD and tiltable viewfinder, which facilitates its use over a full working day. A multi-angle handle with integrated direct access buttons also improves the ergonomics. 	
Licensing and classification	
License information	Interchangeable lens version of the FLIR GF3XX series requires US Department of State License and will be subject to limitations on resale, except inside US. Allow a minimum of 90 days after application submittal for approval.
Imaging and optical data	
IR resolution	320 × 240 pixels
Thermal sensitivity/NETD	<15 mK @ +30°C (+86°F)
Field of view (FOV)	24° × 18°
Minimum focus distance	0.3 m (1.0 ft.)
Focal length	23 mm (0.89 in.)
Lens identification	Automatic
F-number	1.5
Focus	Automatic (one touch) or manual (electric or on the lens)
Zoom	1–8× continuous, digital zoom
Digital image enhancement	Noise reduction filter
Detector data	
Detector type	Focal plane array (FPA), cooled InSb
Spectral range	3–5 μm
Detector pitch	30 μm
Sensor cooling	Stirling Microcooler (FLIR MC-3)

Electronics and data rate	
Full frame rate	60 Hz
Image presentation	
Display	Built-in widescreen, 4.3 in. LCD, 800 × 480 pixels
Viewfinder	Built-in, tiltable OLED, 800 × 480 pixels
Automatic image adjustment	Continuous/manual; linear or histogram based
Manual image adjustment	Level/span
Image presentation modes	
Image modes	IR image, visual image
Measurement	
Temperature range	-20°C to +120°C (-4°F to +248°F)
Accuracy	±1°C (±1.8°F) or ±1% of reading for temperature range 0°C to +120°C (+32°F to +248°F)
Measurement analysis	
Spotmeter	10
Area	5 boxes with max./min./average
Profile	1 live line (horizontal or vertical)
Isotherm	Above/below/interval
Difference temperature	Delta temperature between measurement functions or reference temperature
Reference temperature	Manually set or captured from any measurement function
Emissivity correction	Variable from 0.01 to 1.0 or selected from editable materials list
Reflected apparent temperature correction	Automatic, based on input of reflected temperature
Measurement corrections	Reflected temperature, distance, atmospheric transmission, humidity, external optics
Set-up	
Menu commands	Level, span Auto adjust continuous/manual/semi-automatic Zoom Palette Start/stop recording Store image Playback/recall image
Color palettes	Iron, Gray, Rainbow, Arctic, Lava, Rainbow HC
Set-up commands	1 programmable button, local adaptation of units, language, date and time formats
Storage of images	
Storage media	Removable SD or SDHC memory card , two card slots
Image storage capacity	> 1200 images (JPEG) with post process capability per GB on memory card

Storage of images	
Image storage mode	IR/visual images Visual image can automatically be associated with corresponding IR image
Periodic image storage	Every 10 seconds up to 24 hours
File formats	Standard JPEG, 14 bit measurement data included
Geographic Information System	
GPS	Location data automatically added to every image from built-in GPS
Video recording in camera	
Radiometric IR video recording	*.seq video clips to memory card (7.5 and 15 Hz).
Non-radiometric IR video recording	MPEG4 (up to 60 minutes/clip) to memory card. Visual image can automatically be associated with corresponding recording of non-radiometric IR video.
Visual video recording	MPEG4 (25 minutes/clip) to memory card
Video streaming	
Radiometric IR video streaming	Full dynamic to PC using USB cable or to mobile devices using Wi-Fi. PC software capable of displaying the video stream include the following: <ul style="list-style-type: none"> • FLIR IR Camera Player • FLIR ResearchIR • FLIR Tools
Non-radiometric IR video streaming	RTP/MPEG4
Digital camera	
Built-in digital camera	3.2 Mpixels, auto focus, and two video lamps
Laser pointer	
Laser	Activated by dedicated button
Laser classification	Class 2
Laser type	Semiconductor AlGaInP diode laser, 1 mW, 635 nm (red)
USB	
USB	<ul style="list-style-type: none"> • USB-A: Connect external USB device • USB Mini-B: Data transfer to and from PC
USB, standard	USB Mini-B: 2.0 high speed
Composite video	
Video out	Digital video output (image)
Power system	
Battery type	Rechargeable Li ion battery
Battery voltage	7.2 V
Battery capacity	4.4 Ah
Battery operating time	> 3 hours at 25°C (+77°F) and typical use

Power system	
Charging system	In camera (AC adapter or 12 V from a vehicle) or 2-bay charger
Charging time	2.5 h to 95% capacity, charging status indicated by LED's
External power operation	AC adapter 90–260 VAC, 50/60 Hz or 12 V from a vehicle (cable with standard plug, optional)
DC operation	10.8 to 16 V DC, polarity protected (proprietary protected)
Power	8.5 W typically
Start-up time	Typically 7 min. @ 25°C (+77°F)
Environmental data	
Operating temperature range	–20°C to +50°C (–4°F to +122°F)
Storage temperature range	–30°C to +60°C (–22°F to +140°F)
Humidity (operating and storage)	IEC 68-2-30/24 h 95% relative humidity +25°C to +40°C (+77°F to +104°F) (2 cycles)
Directives	<ul style="list-style-type: none"> • 73/23EEC • 2004/108/EC • 2002/95/EC • 2002/96/EC
EMC	<ul style="list-style-type: none"> • EN61000-6-4 (Emission) • EN61000-6-2 (Immunity) • FCC 47 CFR Part 15 class A (Emission) • EN 61 000-4-8, L5
Encapsulation	IP 54 (IEC 60529)
Shock	25 g (IEC 60068-2-27)
Vibration	2 g (IEC 60068-2-6)
Safety	Power supply: EN/UL/IEC 60950-1
Physical data	
Camera weight, excl. lens and battery	1.94 kg (4.27 lb.)
Camera weight, incl. lens and excl. battery	2.24 kg (4.94 lb.)
Camera weight, incl. lens and battery	2.48 kg (5.47 lb.)
Battery weight	0.24 kg (0.52 lb.)
Heat shield weight	0.50 kg (1.09 lb.)
Camera size, excl. lens (L × W × H)	284 × 169 × 161 mm (11.2 × 6.7 × 6.3 in.)
Cameras size, incl. lens (L × W × H)	306 × 169 × 161 mm (12.0 × 6.7 × 6.3 in.)
Cameras size, incl. heat shield (L × W × H)	320 × 243 × 195 mm (12.6 × 9.6 × 7.7 in.)
Battery size (L × W × H)	141 × 47 × 28 mm (5.5 × 1.8 × 1.1 in.)
Battery charger size (L × W × H)	158 × 122 × 25 mm (6.2 × 4.8 × 1.0 in.)
Tripod mounting	UNC ¼"-20
Housing material	Aluminum, magnesium
Grip material	TPE thermoplastic elastomers

Shipping information	
Packaging, type	Cardboard box
List of contents	<ul style="list-style-type: none"> • Infrared camera with lens • Battery charger • Battery, 2 ea. • FLIR ResearchIR Standard 4 • Hard transport case • HDMI-DVI cable • HDMI-HDMI cable • Lens cap (2 ea.) • Lens cap (mounted on lens) • Memory card • Power supply, incl. multi-plugs • Printed documentation • Shoulder strap • USB cable • Wi-Fi USB micro adapter (depending on CE and FCC regulations regarding wireless equipment for your country)
Packaging, weight	8.35 kg (18.4 lb.)
Packaging, size	400 × 190 × 510 mm (15.7 × 7.5 × 20.1 in.)

Supplies & accessories:

- T198267; IR lens, 24° with case for GF335, GF346
- T198298; IR lens, 14.5° with case for GF335, GF346
- T197692; Battery charger, incl. power supply with multi plugs
- T910814; Power supply, incl. multi plugs
- T198511; Li-Ion Battery pack 7.4V 33Wh
- T199367ACC; Battery Li-ion 7.2 V, 4.4 Ah, 32 Wh
- T911650ACC; Memory card SD Card 8 GB
- 1910423; USB cable Std A <-> Mini-B
- T198509; Cigarette lighter adapter kit, 12 VDC, 1.2 m/3.9 ft.
- T910815ACC; HDMI to HDMI cable 1.5 m
- T910816ACC; HDMI to DVI cable 1.5 m
- T197555; Hard transport case for FLIR GF3xx-Series
- T951387; Wi-Fi USB micro adapter
- T198586; FLIR Reporter Professional (license only)
- T198584; FLIR Tools
- T198583; FLIR Tools+ (download card incl. license key)
- DSW-10000; FLIR IR Camera Player
- APP-10002; FLIR Tools Mobile (Android Application)
- T198697; FLIR ResearchIR Max + HSDR 4 (hardware sec. dev.)
- T199014; FLIR ResearchIR Max + HSDR 4 (printed license key)
- T199044; FLIR ResearchIR Max + HSDR 4 Upgrade (printed license key)
- T198696; FLIR ResearchIR Max 4 (hardware sec. dev.)
- T199013; FLIR ResearchIR Max 4 (printed license key)
- T199043; FLIR ResearchIR Max 4 Upgrade (printed license key)
- T198731; FLIR ResearchIR Standard 4 (hardware sec. dev.)
- T199012; FLIR ResearchIR Standard 4 (printed license key)
- T199042; FLIR ResearchIR Standard 4 Upgrade (printed license key)
- T199233; FLIR Atlas SDK for .NET
- T199234; FLIR Atlas SDK for MATLAB
- T198567; ThermoVision™ System Developers Kit Ver. 2.6
- T198566; ThermoVision™ LabVIEW® Digital Toolkit Ver. 3.3

22.25 FLIR GF343 24° Fixed lens

P/N: 65702-0102

Rev.: 45202

General description	
<p>The new FLIR GF343 is an optical gas camera for visualizing carbon dioxide (CO₂). With this camera you can quickly and easily find gas leaks where CO₂ is the main component.</p>	
<p>Key features:</p> <ul style="list-style-type: none"> • Visualizes gas leaks in real time. • Inspects without interruption of process. • Traces leaks to their source. 	
<p>Carbon capture and storage—stop the escalation of global warming:</p> <ul style="list-style-type: none"> • A global transition to a sustainable low-carbon economy is a necessity. • Global energy demand is still dominated by fossil fuels being combusted in quantities incompatible with levels required to stabilize greenhouse gases concentrations at safe levels in the atmosphere. <p>CO₂ (R744)—the new environmental friendly refrigerant:</p> <ul style="list-style-type: none"> • Air-conditioning for cars—replaces R134a. • CO₂-based heat pumps. • Electrical power—replaces sulfur hexafluoride. <p>CO₂—a harmless tracer gas:</p> <ul style="list-style-type: none"> • Use CO₂ to trace leaks. 	
Note	
<p>The CO₂ background level in the atmosphere varies between about 400 ppm (e.g., outdoors) to 5000 ppm (e.g., very high levels indoors), and the ability to see a CO₂ leak using the FLIR GF343 depends on this gas concentration and also on the distance to the target. For example, an outdoor leak at a distance of 10 m (33') adds 4000 ppm × m to the gas concentration length.</p>	
Imaging and optical data	
IR resolution	320 × 240 pixels
Thermal sensitivity/NETD	<15 mK @ +30°C (+86°F)
Field of view (FOV)	24° × 18°
Minimum focus distance	0.3 m (1.0 ft.)
Focal length	23 mm (0.89 in.)
Lens identification	Automatic
F-number	1.5
Focus	Automatic (one touch) or manual (electric or on the lens)
Zoom	1–8× continuous, digital zoom
Digital image enhancement	Noise reduction filter, high sensitivity mode (HSM)
Detector data	
Detector type	Focal plane array (FPA), cooled InSb
Spectral range	Built-in cold band pass filter 4.2–4.4 μm
Detector pitch	30 μm
Sensor cooling	Stirling Microcooler (FLIR MC-3)
Detects following gases	Carbon dioxide

Electronics and data rate	
Full frame rate	60 Hz
Image presentation	
Display	Built-in widescreen, 4.3 in. LCD, 800 × 480 pixels
Viewfinder	Built-in, tiltable OLED, 800 × 480 pixels
Automatic image adjustment	Continuous/manual; linear or histogram based
Manual image adjustment	Level/span
Image presentation modes	
Image modes	IR image, visual image, high sensitivity mode (HSM)
Set-up	
Menu commands	Level, span Auto adjust continuous/manual/semi-automatic Zoom Palette Start/stop recording Store image Playback/recall image
Color palettes	Iron, Gray, Rainbow, Arctic, Lava, Rainbow HC
Set-up commands	1 programmable button, overlay recording mode, local adaptation of units, language, date and time formats
Storage of images	
Storage media	Removable SD or SDHC memory card , two card slots
Image storage capacity	> 1200 images (JPEG) with post process capability per GB on memory card
Image storage mode	IR/visual images Visual image can automatically be associated with corresponding IR image
Periodic image storage	Every 10 seconds up to 24 hours
File formats	Standard JPEG, 14 bit measurement data included
Geographic Information System	
GPS	Location data automatically added to every image from built-in GPS
Video recording in camera	
Radiometric IR video recording	*.seq video clips to memory card (7.5 and 15 Hz).
Non-radiometric IR video recording	MPEG4 (up to 60 minutes/clip) to memory card. Visual image can automatically be associated with corresponding recording of non-radiometric IR video.
Visual video recording	MPEG4 (25 minutes/clip) to memory card

Video streaming	
Radiometric IR video streaming	Full dynamic to PC using USB cable or to mobile devices using Wi-Fi. PC software capable of displaying the video stream include the following: <ul style="list-style-type: none"> • FLIR IR Camera Player • FLIR ResearchIR • FLIR Tools
Non-radiometric IR video streaming	RTP/MPEG4
Digital camera	
Built-in digital camera	3.2 Mpixels, auto focus, and two video lamps
Laser pointer	
Laser	Activated by dedicated button
Laser classification	Class 2
Laser type	Semiconductor AlGaInP diode laser, 1 mW, 635 nm (red)
USB	
USB	<ul style="list-style-type: none"> • USB-A: Connect external USB device • USB Mini-B: Data transfer to and from PC
USB, standard	USB Mini-B: 2.0 high speed
Composite video	
Video out	Digital video output (image)
Power system	
Battery type	Rechargeable Li ion battery
Battery voltage	7.2 V
Battery capacity	4.4 Ah
Battery operating time	> 3 hours at 25°C (+77°F) and typical use
Charging system	In camera (AC adapter or 12 V from a vehicle) or 2-bay charger
Charging time	2.5 h to 95% capacity, charging status indicated by LED's
External power operation	AC adapter 90–260 VAC, 50/60 Hz or 12 V from a vehicle (cable with standard plug, optional)
DC operation	10.8 to 16 V DC, polarity protected (proprietary protected)
Power	8.5 W typically
Start-up time	Typically 7 min. @ 25°C (+77°F)
Environmental data	
Operating temperature range	–20°C to +50°C (–4°F to +122°F)
Storage temperature range	–30°C to +60°C (–22°F to +140°F)
Humidity (operating and storage)	IEC 68-2-30/24 h 95% relative humidity +25°C to +40°C (+77°F to +104°F) (2 cycles)

Environmental data	
Directives	<ul style="list-style-type: none"> • 73/23EEC • 2004/108/EC • 2002/95/EC • 2002/96/EC
EMC	<ul style="list-style-type: none"> • EN61000-6-4 (Emission) • EN61000-6-2 (Immunity) • FCC 47 CFR Part 15 class A (Emission) • EN 61 000-4-8, L5
Encapsulation	IP 54 (IEC 60529)
Shock	25 g (IEC 60068-2-27)
Vibration	2 g (IEC 60068-2-6)
Safety	Power supply: EN/UL/IEC 60950-1
Physical data	
Camera weight, excl. lens and battery	1.94 kg (4.27 lb.)
Camera weight, incl. lens and excl. battery	2.24 kg (4.94 lb.)
Camera weight, incl. lens and battery	2.48 kg (5.47 lb.)
Battery weight	0.24 kg (0.52 lb.)
Camera size, excl. lens (L × W × H)	284 × 169 × 161 mm (11.2 × 6.7 × 6.3 in.)
Cameras size, incl. lens (L × W × H)	306 × 169 × 161 mm (12.0 × 6.7 × 6.3 in.)
Battery size (L × W × H)	141 × 47 × 28 mm (5.5 × 1.8 × 1.1 in.)
Battery charger size (L × W × H)	158 × 122 × 25 mm (6.2 × 4.8 × 1.0 in.)
Tripod mounting	UNC ¼"-20
Housing material	Aluminum, magnesium
Grip material	TPE thermoplastic elastomers
Shipping information	
Packaging, type	Cardboard box
List of contents	<ul style="list-style-type: none"> • Infrared camera with lens • Battery charger • Battery, 2 ea. • Hard transport case • HDMI-DVI cable • HDMI-HDMI cable • Lens cap (mounted on lens) • Memory card • Power supply, incl. multi-plugs • Printed documentation • Shoulder strap • USB cable • Wi-Fi USB micro adapter (depending on CE and FCC regulations regarding wireless equipment for your country)
Packaging, weight	
Packaging, size	400 × 190 × 510 mm (15.7 × 7.5 × 20.1 in.)
EAN-13	7332558008485
UPC-12	845188008840
Country of origin	Sweden

Supplies & accessories:

- T198511; Li-Ion Battery pack 7.4V 33Wh
- T199367ACC; Battery Li-ion 7.2 V, 4.4 Ah, 32 Wh
- T199233; FLIR Atlas SDK for .NET
- T199234; FLIR Atlas SDK for MATLAB

22.26 FLIR GF346 14.5°

P/N: 59801-0101

Rev.: 45202

General description	
<p>The FLIR GF346 is an infrared camera for optical gas imaging (OGI) that visualizes and pinpoints gas leaks of carbon monoxide (CO) and other harmful gases, without the need to shut down the operation. The portable camera also greatly improves operator safety, by detecting emissions at a safe distance, and helps to protect the environment by tracing leaks of environmentally harmful gases.</p> <p>CO is an industrial gas with applications in the steel industry and bulk chemicals manufacturing. It is also used for packaging systems for fresh meat and fish.</p>	
Benefits:	
<ul style="list-style-type: none"> Improved efficiency: The FLIR GF346 reduces revenue loss by pinpointing even small gas leaks quickly and efficiently, and from a distance. It also reduces the inspection time by allowing a broad area to be scanned rapidly and without the need to interrupt the industrial process. The wireless connectivity of the camera allows you to connect to smart phones or tablets for the wireless transfer of images or remote control of the camera. The FLIR GF346 can also be used for temperature measurement, which makes it even more useful for predictive maintenance. Increased worker safety: CO can be toxic to humans when encountered in higher concentrations. OGI allows gas leaks to be detected in a non-contact mode and from a safe distance. This reduces the risk of the user being exposed to invisible and highly toxic gases or explosive chemicals. With a FLIR GF346 gas imaging camera it is easy to scan areas of interest that are difficult to reach with conventional methods. The camera is ergonomically designed, with a bright LCD and tiltable viewfinder, which facilitates its use over a full working day. Protecting the environment: Several gases, such as CO, have a high global warming potential, and are usually governed by regulations. Even small leaks can be detected and documented using the FLIR GF346 camera. 	
<p>Detects the following gases: carbon monoxide, nitrous oxide, ketene, ethenone, butyl isocyanide, hexyl isocyanide, cyanogen bromide, acetonitrile, acetyl cyanide, chlorine isocyanate, bromine isocyanate, methyl thiocyanate, ethyl thiocyanate, chlorodimethylsilane, dichloromethylsilane, silane, germane, arsine.</p>	
Licensing and classification	
License information	Interchangeable lens version of the FLIR GF3XX series requires US Department of State License and will be subject to limitations on resale, except inside US. Allow a minimum of 90 days after application submittal for approval.
Imaging and optical data	
IR resolution	320 × 240 pixels
Thermal sensitivity/NETD	<15 mK @ +30°C (+86°F)
Field of view (FOV)	14.5° × 10.8°
Minimum focus distance	0.5 m (1.64 ft.)
Focal length	38 mm (1.49 in.)
Lens identification	Automatic
F-number	1.5
Focus	Automatic (one touch) or manual (electric or on the lens)
Zoom	1–8× continuous, digital zoom
Digital image enhancement	Noise reduction filter, high sensitivity mode (HSM)

Detector data	
Detector type	Focal plane array (FPA), cooled InSb
Spectral range	Built-in cold band pass filter 4.52–4.67 μm
Detector pitch	30 μm
Sensor cooling	Stirling Microcooler (FLIR MC-3)
Detects following gases	Carbon Monoxide, Nitrous Oxide, Ketene, Ethene, Ethylene, Butyl Isocyanide, Hexyl Isocyanide, Cyanogen Bromide, Acetonitrile, Acetyl Cyanide, Chlorine Isocyanate, Bromine Isocyanate, Methyl Thiocyanate, Ethyl Thiocyanate, Chlorodimethylsilane, Dichloromethylsilane, Silane, Germane, Arsine
Electronics and data rate	
Full frame rate	60 Hz
Image presentation	
Display	Built-in widescreen, 4.3 in. LCD, 800 \times 480 pixels
Viewfinder	Built-in, tiltable OLED, 800 \times 480 pixels
Automatic image adjustment	Continuous/manual; linear or histogram based
Manual image adjustment	Level/span
Image presentation modes	
Image modes	IR image, visual image, high sensitivity mode (HSM)
Measurement	
Temperature range	-20°C to +300°C (-4°F to +572°F)
Accuracy	$\pm 1^\circ\text{C}$ ($\pm 1.8^\circ\text{F}$) or $\pm 1\%$ of reading for temperature range 0°C to +300°C (+32°F to +572°F)
Measurement analysis	
Spotmeter	10
Area	5 boxes with max./min./average
Profile	1 live line (horizontal or vertical)
Difference temperature	Delta temperature between measurement functions or reference temperature
Reference temperature	Manually set or captured from any measurement function
Emissivity correction	Variable from 0.01 to 1.0 or selected from editable materials list
Reflected apparent temperature correction	Automatic, based on input of reflected temperature
Measurement corrections	Reflected temperature, distance, atmospheric transmission, humidity, external optics

Set-up	
Menu commands	Level, span Auto adjust continuous/manual/semi-automatic Zoom Palette Start/stop recording Store image Playback/recall image
Color palettes	Iron, Gray, Rainbow, Arctic, Lava, Rainbow HC
Set-up commands	1 programmable button, overlay recording mode, local adaptation of units, language, date and time formats
Storage of images	
Storage media	Removable SD or SDHC memory card , two card slots
Image storage capacity	> 1200 images (JPEG) with post process capability per GB on memory card
Image storage mode	IR/visual images Visual image can automatically be associated with corresponding IR image
Periodic image storage	Every 10 seconds up to 24 hours
File formats	Standard JPEG, 14 bit measurement data included
Geographic Information System	
GPS	Location data automatically added to every image from built-in GPS
Video recording in camera	
Radiometric IR video recording	*.seq video clips to memory card (7.5 and 15 Hz).
Non-radiometric IR video recording	MPEG4 (up to 60 minutes/clip) to memory card. Visual image can automatically be associated with corresponding recording of non-radiometric IR video.
Visual video recording	MPEG4 (25 minutes/clip) to memory card
Video streaming	
Radiometric IR video streaming	Full dynamic to PC using USB cable or to mobile devices using Wi-Fi. PC software capable of displaying the video stream include the following: <ul style="list-style-type: none"> • FLIR IR Camera Player • FLIR ResearchIR • FLIR Tools
Non-radiometric IR video streaming	RTP/MPEG4
Digital camera	
Built-in digital camera	3.2 Mpixels, auto focus, and two video lamps

Laser pointer	
Laser	Activated by dedicated button
Laser classification	Class 2
Laser type	Semiconductor AlGaInP diode laser, 1 mW, 635 nm (red)
USB	
USB	<ul style="list-style-type: none"> • USB-A: Connect external USB device • USB Mini-B: Data transfer to and from PC
USB, standard	USB Mini-B: 2.0 high speed
Composite video	
Video out	Digital video output (image)
Power system	
Battery type	Rechargeable Li ion battery
Battery voltage	7.2 V
Battery capacity	4.4 Ah
Battery operating time	> 3 hours at 25°C (+77°F) and typical use
Charging system	In camera (AC adapter or 12 V from a vehicle) or 2-bay charger
Charging time	2.5 h to 95% capacity, charging status indicated by LED's
External power operation	AC adapter 90–260 VAC, 50/60 Hz or 12 V from a vehicle (cable with standard plug, optional)
DC operation	10.8 to 16 V DC, polarity protected (proprietary protected)
Power	8.5 W typically
Start-up time	Typically 7 min. @ 25°C (+77°F)
Environmental data	
Operating temperature range	–20°C to +50°C (–4°F to +122°F)
Storage temperature range	–30°C to +60°C (–22°F to +140°F)
Humidity (operating and storage)	IEC 68-2-30/24 h 95% relative humidity +25°C to +40°C (+77°F to +104°F) (2 cycles)
Directives	<ul style="list-style-type: none"> • 73/23EEC • 2004/108/EC • 2002/95/EC • 2002/96/EC
EMC	<ul style="list-style-type: none"> • EN61000-6-4 (Emission) • EN61000-6-2 (Immunity) • FCC 47 CFR Part 15 class A (Emission) • EN 61 000-4-8, L5
Encapsulation	IP 54 (IEC 60529)
Shock	25 g (IEC 60068-2-27)
Vibration	2 g (IEC 60068-2-6)
Safety	Power supply: EN/UL/IEC 60950-1

Physical data	
Camera weight, excl. lens and battery	1.94 kg (4.27 lb.)
Camera weight, incl. lens and excl. battery	2.24 kg (4.94 lb.)
Camera weight, incl. lens and battery	2.48 kg (5.47 lb.)
Battery weight	0.24 kg (0.52 lb.)
Camera size, excl. lens (L × W × H)	284 × 169 × 161 mm (11.2 × 6.7 × 6.3 in.)
Cameras size, incl. lens (L × W × H)	305 × 169 × 161 mm (12.0 × 6.7 × 6.3 in.)
Battery size (L × W × H)	141 × 47 × 28 mm (5.5 × 1.8 × 1.1 in.)
Battery charger size (L × W × H)	158 × 122 × 25 mm (6.2 × 4.8 × 1.0 in.)
Tripod mounting	UNC ¼"-20
Housing material	Aluminum, magnesium
Grip material	TPE thermoplastic elastomers
Shipping information	
Packaging, type	Cardboard box
List of contents	<ul style="list-style-type: none"> • Infrared camera with lens • Battery charger • Battery, 2 ea. • Hard transport case • HDMI-DVI cable • HDMI-HDMI cable • Lens cap (2 ea.) • Lens cap (mounted on lens) • Memory card • Power supply, incl. multi-plugs • Printed documentation • Shoulder strap • USB cable • Wi-Fi USB micro adapter (depending on CE and FCC regulations regarding wireless equipment for your country)
Packaging, weight	
Packaging, size	400 × 190 × 510 mm (15.7 × 7.5 × 20.1 in.)

Supplies & accessories:

- T197388; IR lens, 6° with case for GF300, GF309, GF320, GF346.
- T198267; IR lens, 24° with case for GF335, GF346
- T198298; IR lens, 14.5° with case for GF335, GF346
- T197692; Battery charger, incl. power supply with multi plugs
- T910814; Power supply, incl. multi plugs
- T198511; Li-Ion Battery pack 7.4V 33Wh
- T199367ACC; Battery Li-ion 7.2 V, 4.4 Ah, 32 Wh
- T911650ACC; Memory card SD Card 8 GB
- 1910423; USB cable Std A <-> Mini-B
- T198509; Cigarette lighter adapter kit, 12 VDC, 1.2 m/3.9 ft.
- T910815ACC; HDMI to HDMI cable 1.5 m
- T910816ACC; HDMI to DVI cable 1.5 m
- T197555; Hard transport case for FLIR GF3xx-Series
- T951387; Wi-Fi USB micro adapter
- T198586; FLIR Reporter Professional (license only)
- T198584; FLIR Tools

- T198583; FLIR Tools+ (download card incl. license key)
- T198585; FLIR VideoReport
- DSW-10000; FLIR IR Camera Player
- APP-10002; FLIR Tools Mobile (Android Application)
- T198697; FLIR ResearchIR Max + HSDR 4 (hardware sec. dev.)
- T199014; FLIR ResearchIR Max + HSDR 4 (printed license key)
- T199044; FLIR ResearchIR Max + HSDR 4 Upgrade (printed license key)
- T198696; FLIR ResearchIR Max 4 (hardware sec. dev.)
- T199013; FLIR ResearchIR Max 4 (printed license key)
- T199043; FLIR ResearchIR Max 4 Upgrade (printed license key)
- T198731; FLIR ResearchIR Standard 4 (hardware sec. dev.)
- T199012; FLIR ResearchIR Standard 4 (printed license key)
- T199042; FLIR ResearchIR Standard 4 Upgrade (printed license key)
- T199233; FLIR Atlas SDK for .NET
- T199234; FLIR Atlas SDK for MATLAB
- T198567; ThermoVision™ System Developers Kit Ver. 2.6
- T198566; ThermoVision™ LabVIEW® Digital Toolkit Ver. 3.3

22.27 FLIR GF346 14.5° Fixed lens

P/N: 59802-0101

Rev.: 45202

General description	
<p>The FLIR GF346 is an infrared camera for optical gas imaging (OGI) that visualizes and pinpoints gas leaks of carbon monoxide (CO) and other harmful gases, without the need to shut down the operation. The portable camera also greatly improves operator safety, by detecting emissions at a safe distance, and helps to protect the environment by tracing leaks of environmentally harmful gases.</p> <p>CO is an industrial gas with applications in the steel industry and bulk chemicals manufacturing. It is also used for packaging systems for fresh meat and fish.</p>	
Benefits:	
<ul style="list-style-type: none"> Improved efficiency: The FLIR GF346 reduces revenue loss by pinpointing even small gas leaks quickly and efficiently, and from a distance. It also reduces the inspection time by allowing a broad area to be scanned rapidly and without the need to interrupt the industrial process. The wireless connectivity of the camera allows you to connect to smart phones or tablets for the wireless transfer of images or remote control of the camera. The FLIR GF346 can also be used for temperature measurement, which makes it even more useful for predictive maintenance. Increased worker safety: CO can be toxic to humans when encountered in higher concentrations. OGI allows gas leaks to be detected in a non-contact mode and from a safe distance. This reduces the risk of the user being exposed to invisible and highly toxic gases or explosive chemicals. With a FLIR GF346 gas imaging camera it is easy to scan areas of interest that are difficult to reach with conventional methods. The camera is ergonomically designed, with a bright LCD and tiltable viewfinder, which facilitates its use over a full working day. Protecting the environment: Several gases, such as CO, have a high global warming potential, and are usually governed by regulations. Even small leaks can be detected and documented using the FLIR GF346 camera. 	
<p>Detects the following gases: carbon monoxide, nitrous oxide, ketene, ethenone, butyl isocyanide, hexyl isocyanide, cyanogen bromide, acetonitrile, acetyl cyanide, chlorine isocyanate, bromine isocyanate, methyl thiocyanate, ethyl thiocyanate, chlorodimethylsilane, dichloromethylsilane, silane, germane, arsine.</p>	
Imaging and optical data	
IR resolution	320 × 240 pixels
Thermal sensitivity/NETD	<15 mK @ +30°C (+86°F)
Field of view (FOV)	14.5° × 10.8°
Minimum focus distance	0.5 m (1.64 ft.)
Focal length	38 mm (1.49 in.)
Lens identification	Automatic
F-number	1.5
Focus	Automatic (one touch) or manual (electric or on the lens)
Zoom	1–8× continuous, digital zoom
Digital image enhancement	Noise reduction filter, high sensitivity mode (HSM)
Detector data	
Detector type	Focal plane array (FPA), cooled InSb
Spectral range	Built-in cold band pass filter 4.52–4.67 μm
Detector pitch	30 μm

Detector data	
Sensor cooling	Stirling Microcooler (FLIR MC-3)
Detects following gases	Carbon Monoxide, Nitrous Oxide, Ketene, Ethene, Butyl Isocyanide, Hexyl Isocyanide, Cyanogen Bromide, Acetonitrile, Acetyl Cyanide, Chlorine Isocyanate, Bromine Isocyanate, Methyl Thiocyanate, Ethyl Thiocyanate, Chlorodimethylsilane, Dichloromethylsilane, Silane, Germane, Arsine
Electronics and data rate	
Full frame rate	60 Hz
Image presentation	
Display	Built-in widescreen, 4.3 in. LCD, 800 × 480 pixels
Viewfinder	Built-in, tiltable OLED, 800 × 480 pixels
Automatic image adjustment	Continuous/manual; linear or histogram based
Manual image adjustment	Level/span
Image presentation modes	
Image modes	IR image, visual image, high sensitivity mode (HSM)
Measurement	
Temperature range	-20°C to +300°C (-4°F to +572°F)
Accuracy	±1°C (±1.8°F) or ±1% of reading for temperature range 0°C to +300°C (+32°F to +572°F)
Measurement analysis	
Spotmeter	10
Area	5 boxes with max./min./average
Profile	1 live line (horizontal or vertical)
Difference temperature	Delta temperature between measurement functions or reference temperature
Reference temperature	Manually set or captured from any measurement function
Emissivity correction	Variable from 0.01 to 1.0 or selected from editable materials list
Reflected apparent temperature correction	Automatic, based on input of reflected temperature
Measurement corrections	Reflected temperature, distance, atmospheric transmission, humidity, external optics

Set-up	
Menu commands	Level, span Auto adjust continuous/manual/semi-automatic Zoom Palette Start/stop recording Store image Playback/recall image
Color palettes	Iron, Gray, Rainbow, Arctic, Lava, Rainbow HC
Set-up commands	1 programmable button, overlay recording mode, local adaptation of units, language, date and time formats
Storage of images	
Storage media	Removable SD or SDHC memory card , two card slots
Image storage capacity	> 1200 images (JPEG) with post process capability per GB on memory card
Image storage mode	IR/visual images Visual image can automatically be associated with corresponding IR image
Periodic image storage	Every 10 seconds up to 24 hours
File formats	Standard JPEG, 14 bit measurement data included
Geographic Information System	
GPS	Location data automatically added to every image from built-in GPS
Video recording in camera	
Radiometric IR video recording	*.seq video clips to memory card (7.5 and 15 Hz).
Non-radiometric IR video recording	MPEG4 (up to 60 minutes/clip) to memory card. Visual image can automatically be associated with corresponding recording of non-radiometric IR video.
Visual video recording	MPEG4 (25 minutes/clip) to memory card
Video streaming	
Radiometric IR video streaming	Full dynamic to PC using USB cable or to mobile devices using Wi-Fi. PC software capable of displaying the video stream include the following: <ul style="list-style-type: none"> • FLIR IR Camera Player • FLIR ResearchIR • FLIR Tools
Non-radiometric IR video streaming	RTP/MPEG4
Digital camera	
Built-in digital camera	3.2 Mpixels, auto focus, and two video lamps

Laser pointer	
Laser	Activated by dedicated button
Laser classification	Class 2
Laser type	Semiconductor AlGaInP diode laser, 1 mW, 635 nm (red)
USB	
USB	<ul style="list-style-type: none"> • USB-A: Connect external USB device • USB Mini-B: Data transfer to and from PC
USB, standard	USB Mini-B: 2.0 high speed
Composite video	
Video out	Digital video output (image)
Power system	
Battery type	Rechargeable Li ion battery
Battery voltage	7.2 V
Battery capacity	4.4 Ah
Battery operating time	> 3 hours at 25°C (+77°F) and typical use
Charging system	In camera (AC adapter or 12 V from a vehicle) or 2-bay charger
Charging time	2.5 h to 95% capacity, charging status indicated by LED's
External power operation	AC adapter 90–260 VAC, 50/60 Hz or 12 V from a vehicle (cable with standard plug, optional)
DC operation	10.8 to 16 V DC, polarity protected (proprietary protected)
Power	8.5 W typically
Start-up time	Typically 7 min. @ 25°C (+77°F)
Environmental data	
Operating temperature range	–20°C to +50°C (–4°F to +122°F)
Storage temperature range	–30°C to +60°C (–22°F to +140°F)
Humidity (operating and storage)	IEC 68-2-30/24 h 95% relative humidity +25°C to +40°C (+77°F to +104°F) (2 cycles)
Directives	<ul style="list-style-type: none"> • 73/23EEC • 2004/108/EC • 2002/95/EC • 2002/96/EC
EMC	<ul style="list-style-type: none"> • EN61000-6-4 (Emission) • EN61000-6-2 (Immunity) • FCC 47 CFR Part 15 class A (Emission) • EN 61 000-4-8, L5
Encapsulation	IP 54 (IEC 60529)
Shock	25 g (IEC 60068-2-27)
Vibration	2 g (IEC 60068-2-6)
Safety	Power supply: EN/UL/IEC 60950-1

Physical data	
Camera weight, excl. lens and battery	1.94 kg (4.27 lb.)
Camera weight, incl. lens and excl. battery	2.24 kg (4.94 lb.)
Camera weight, incl. lens and battery	2.48 kg (5.47 lb.)
Battery weight	0.24 kg (0.52 lb.)
Camera size, excl. lens (L × W × H)	284 × 169 × 161 mm (11.2 × 6.7 × 6.3 in.)
Cameras size, incl. lens (L × W × H)	305 × 169 × 161 mm (12.0 × 6.7 × 6.3 in.)
Battery size (L × W × H)	141 × 47 × 28 mm (5.5 × 1.8 × 1.1 in.)
Battery charger size (L × W × H)	158 × 122 × 25 mm (6.2 × 4.8 × 1.0 in.)
Tripod mounting	UNC ¼"-20
Housing material	Aluminum, magnesium
Grip material	TPE thermoplastic elastomers
Shipping information	
Packaging, type	Cardboard box
List of contents	<ul style="list-style-type: none"> • Infrared camera with lens • Battery charger • Battery, 2 ea. • Hard transport case • HDMI-DVI cable • HDMI-HDMI cable • Lens cap (mounted on lens) • Memory card • Power supply, incl. multi-plugs • Printed documentation • Shoulder strap • USB cable • Wi-Fi USB micro adapter (depending on CE and FCC regulations regarding wireless equipment for your country)
Packaging, weight	
Packaging, size	400 × 190 × 510 mm (15.7 × 7.5 × 20.1 in.)

Supplies & accessories:

- T197692; Battery charger, incl. power supply with multi plugs
- T910814; Power supply, incl. multi plugs
- T198511; Li-Ion Battery pack 7.4V 33Wh
- T199367ACC; Battery Li-ion 7.2 V, 4.4 Ah, 32 Wh
- T911650ACC; Memory card SD Card 8 GB
- 1910423; USB cable Std A <-> Mini-B
- T198509; Cigarette lighter adapter kit, 12 VDC, 1.2 m/3.9 ft.
- T910815ACC; HDMI to HDMI cable 1.5 m
- T910816ACC; HDMI to DVI cable 1.5 m
- T197555; Hard transport case for FLIR GF3xx-Series
- T951387; Wi-Fi USB micro adapter
- T198586; FLIR Reporter Professional (license only)
- T198584; FLIR Tools
- T198583; FLIR Tools+ (download card incl. license key)
- T198585; FLIR VideoReport
- DSW-10000; FLIR IR Camera Player
- APP-10002; FLIR Tools Mobile (Android Application)

- T198697; FLIR ResearchIR Max + HSDR 4 (hardware sec. dev.)
- T199014; FLIR ResearchIR Max + HSDR 4 (printed license key)
- T199044; FLIR ResearchIR Max + HSDR 4 Upgrade (printed license key)
- T198696; FLIR ResearchIR Max 4 (hardware sec. dev.)
- T199013; FLIR ResearchIR Max 4 (printed license key)
- T199043; FLIR ResearchIR Max 4 Upgrade (printed license key)
- T198731; FLIR ResearchIR Standard 4 (hardware sec. dev.)
- T199012; FLIR ResearchIR Standard 4 (printed license key)
- T199042; FLIR ResearchIR Standard 4 Upgrade (printed license key)
- T199233; FLIR Atlas SDK for .NET
- T199234; FLIR Atlas SDK for MATLAB
- T198567; ThermoVision™ System Developers Kit Ver. 2.6
- T198566; ThermoVision™ LabVIEW® Digital Toolkit Ver. 3.3

22.28 FLIR GF346 24°

P/N: 59801-0102

Rev.: 45203

General description	
<p>The FLIR GF346 is an infrared camera for optical gas imaging (OGI) that visualizes and pinpoints gas leaks of carbon monoxide (CO) and other harmful gases, without the need to shut down the operation. The portable camera also greatly improves operator safety, by detecting emissions at a safe distance, and helps to protect the environment by tracing leaks of environmentally harmful gases.</p> <p>CO is an industrial gas with applications in the steel industry and bulk chemicals manufacturing. It is also used for packaging systems for fresh meat and fish.</p>	
Benefits:	
<ul style="list-style-type: none"> • Improved efficiency: The FLIR GF346 reduces revenue loss by pinpointing even small gas leaks quickly and efficiently, and from a distance. It also reduces the inspection time by allowing a broad area to be scanned rapidly and without the need to interrupt the industrial process. The wireless connectivity of the camera allows you to connect to smart phones or tablets for the wireless transfer of images or remote control of the camera. The FLIR GF346 can also be used for temperature measurement, which makes it even more useful for predictive maintenance. • Increased worker safety: CO can be toxic to humans when encountered in higher concentrations. OGI allows gas leaks to be detected in a non-contact mode and from a safe distance. This reduces the risk of the user being exposed to invisible and highly toxic gases or explosive chemicals. With a FLIR GF346 gas imaging camera it is easy to scan areas of interest that are difficult to reach with conventional methods. The camera is ergonomically designed, with a bright LCD and tiltable viewfinder, which facilitates its use over a full working day. • Protecting the environment: Several gases, such as CO, have a high global warming potential, and are usually governed by regulations. Even small leaks can be detected and documented using the FLIR GF346 camera. 	
<p>Detects the following gases: carbon monoxide, nitrous oxide, ketene, ethenone, butyl isocyanide, hexyl isocyanide, cyanogen bromide, acetonitrile, acetyl cyanide, chlorine isocyanate, bromine isocyanate, methyl thiocyanate, ethyl thiocyanate, chlorodimethylsilane, dichloromethylsilane, silane, germane, arsine.</p>	
Licensing and classification	
License information	Interchangeable lens version of the FLIR GF3XX series requires US Department of State License and will be subject to limitations on resale, except inside US. Allow a minimum of 90 days after application submittal for approval.
Imaging and optical data	
IR resolution	320 × 240 pixels
Thermal sensitivity/NETD	<15 mK @ +30°C (+86°F)
Field of view (FOV)	24° × 18°
Minimum focus distance	0.3 m (1.0 ft.)
Focal length	23 mm (0.89 in.)
Lens identification	Automatic
F-number	1.5
Focus	Automatic (one touch) or manual (electric or on the lens)
Zoom	1–8× continuous, digital zoom
Digital image enhancement	Noise reduction filter, high sensitivity mode (HSM)

Detector data	
Detector type	Focal plane array (FPA), cooled InSb
Spectral range	Built-in cold band pass filter 4.52–4.67 μm
Detector pitch	30 μm
Sensor cooling	Stirling Microcooler (FLIR MC-3)
Detects following gases	Carbon Monoxide, Nitrous Oxide, Ketene, Ethene, Ethylene, Butyl Isocyanide, Hexyl Isocyanide, Cyanogen Bromide, Acetonitrile, Acetyl Cyanide, Chlorine Isocyanate, Bromine Isocyanate, Methyl Thiocyanate, Ethyl Thiocyanate, Chlorodimethylsilane, Dichloromethylsilane, Silane, Germane, Arsine
Electronics and data rate	
Full frame rate	60 Hz
Image presentation	
Display	Built-in widescreen, 4.3 in. LCD, 800 \times 480 pixels
Viewfinder	Built-in, tiltable OLED, 800 \times 480 pixels
Automatic image adjustment	Continuous/manual; linear or histogram based
Manual image adjustment	Level/span
Image presentation modes	
Image modes	IR image, visual image, high sensitivity mode (HSM)
Measurement	
Temperature range	-20°C to +300°C (-4°F to +572°F)
Accuracy	$\pm 1^\circ\text{C}$ ($\pm 1.8^\circ\text{F}$) or $\pm 1\%$ of reading for temperature range 0°C to +300°C (+32°F to +572°F)
Measurement analysis	
Spotmeter	10
Area	5 boxes with max./min./average
Profile	1 live line (horizontal or vertical)
Difference temperature	Delta temperature between measurement functions or reference temperature
Reference temperature	Manually set or captured from any measurement function
Emissivity correction	Variable from 0.01 to 1.0 or selected from editable materials list
Reflected apparent temperature correction	Automatic, based on input of reflected temperature
Measurement corrections	Reflected temperature, distance, atmospheric transmission, humidity, external optics

Set-up	
Menu commands	Level, span Auto adjust continuous/manual/semi-automatic Zoom Palette Start/stop recording Store image Playback/recall image
Color palettes	Iron, Gray, Rainbow, Arctic, Lava, Rainbow HC
Set-up commands	1 programmable button, overlay recording mode, local adaptation of units, language, date and time formats
Storage of images	
Storage media	Removable SD or SDHC memory card , two card slots
Image storage capacity	> 1200 images (JPEG) with post process capability per GB on memory card
Image storage mode	IR/visual images Visual image can automatically be associated with corresponding IR image
Periodic image storage	Every 10 seconds up to 24 hours
File formats	Standard JPEG, 14 bit measurement data included
Geographic Information System	
GPS	Location data automatically added to every image from built-in GPS
Video recording in camera	
Radiometric IR video recording	*.seq video clips to memory card (7.5 and 15 Hz).
Non-radiometric IR video recording	MPEG4 (up to 60 minutes/clip) to memory card. Visual image can automatically be associated with corresponding recording of non-radiometric IR video.
Visual video recording	MPEG4 (25 minutes/clip) to memory card
Video streaming	
Radiometric IR video streaming	Full dynamic to PC using USB cable or to mobile devices using Wi-Fi. PC software capable of displaying the video stream include the following: <ul style="list-style-type: none"> • FLIR IR Camera Player • FLIR ResearchIR • FLIR Tools
Non-radiometric IR video streaming	RTP/MPEG4
Digital camera	
Built-in digital camera	3.2 Mpixels, auto focus, and two video lamps

Laser pointer	
Laser	Activated by dedicated button
Laser classification	Class 2
Laser type	Semiconductor AlGaInP diode laser, 1 mW, 635 nm (red)
USB	
USB	<ul style="list-style-type: none"> • USB-A: Connect external USB device • USB Mini-B: Data transfer to and from PC
USB, standard	USB Mini-B: 2.0 high speed
Composite video	
Video out	Digital video output (image)
Power system	
Battery type	Rechargeable Li ion battery
Battery voltage	7.2 V
Battery capacity	4.4 Ah
Battery operating time	> 3 hours at 25°C (+77°F) and typical use
Charging system	In camera (AC adapter or 12 V from a vehicle) or 2-bay charger
Charging time	2.5 h to 95% capacity, charging status indicated by LED's
External power operation	AC adapter 90–260 VAC, 50/60 Hz or 12 V from a vehicle (cable with standard plug, optional)
DC operation	10.8 to 16 V DC, polarity protected (proprietary protected)
Power	8.5 W typically
Start-up time	Typically 7 min. @ 25°C (+77°F)
Environmental data	
Operating temperature range	–20°C to +50°C (–4°F to +122°F)
Storage temperature range	–30°C to +60°C (–22°F to +140°F)
Humidity (operating and storage)	IEC 68-2-30/24 h 95% relative humidity +25°C to +40°C (+77°F to +104°F) (2 cycles)
Directives	<ul style="list-style-type: none"> • 73/23EEC • 2004/108/EC • 2002/95/EC • 2002/96/EC
EMC	<ul style="list-style-type: none"> • EN61000-6-4 (Emission) • EN61000-6-2 (Immunity) • FCC 47 CFR Part 15 class A (Emission) • EN 61 000-4-8, L5
Encapsulation	IP 54 (IEC 60529)
Shock	25 g (IEC 60068-2-27)
Vibration	2 g (IEC 60068-2-6)
Safety	Power supply: EN/UL/IEC 60950-1

Physical data	
Camera weight, excl. lens and battery	1.94 kg (4.27 lb.)
Camera weight, incl. lens and excl. battery	2.24 kg (4.94 lb.)
Camera weight, incl. lens and battery	2.48 kg (5.47 lb.)
Battery weight	0.24 kg (0.52 lb.)
Camera size, excl. lens (L × W × H)	284 × 169 × 161 mm (11.2 × 6.7 × 6.3 in.)
Cameras size, incl. lens (L × W × H)	306 × 169 × 161 mm (12.0 × 6.7 × 6.3 in.)
Battery size (L × W × H)	141 × 47 × 28 mm (5.5 × 1.8 × 1.1 in.)
Battery charger size (L × W × H)	158 × 122 × 25 mm (6.2 × 4.8 × 1.0 in.)
Tripod mounting	UNC ¼"-20
Housing material	Aluminum, magnesium
Grip material	TPE thermoplastic elastomers
Shipping information	
Packaging, type	Cardboard box
List of contents	<ul style="list-style-type: none"> • Infrared camera with lens • Battery charger • Battery, 2 ea. • Hard transport case • HDMI-DVI cable • HDMI-HDMI cable • Lens cap (2 ea.) • Lens cap (mounted on lens) • Memory card • Power supply, incl. multi-plugs • Printed documentation • Shoulder strap • USB cable • Wi-Fi USB micro adapter (depending on CE and FCC regulations regarding wireless equipment for your country)
Packaging, weight	
Packaging, size	400 × 190 × 510 mm (15.7 × 7.5 × 20.1 in.)

Supplies & accessories:

- T197388; IR lens, 6° with case for GF300, GF309, GF320, GF346.
- T198267; IR lens, 24° with case for GF335, GF346
- T198298; IR lens, 14.5° with case for GF335, GF346
- T197692; Battery charger, incl. power supply with multi plugs
- T910814; Power supply, incl. multi plugs
- T198511; Li-Ion Battery pack 7.4V 33Wh
- T199367ACC; Battery Li-ion 7.2 V, 4.4 Ah, 32 Wh
- T911650ACC; Memory card SD Card 8 GB
- 1910423; USB cable Std A <-> Mini-B
- T198509; Cigarette lighter adapter kit, 12 VDC, 1.2 m/3.9 ft.
- T910815ACC; HDMI to HDMI cable 1.5 m
- T910816ACC; HDMI to DVI cable 1.5 m
- T197555; Hard transport case for FLIR GF3xx-Series
- T951387; Wi-Fi USB micro adapter
- T198586; FLIR Reporter Professional (license only)
- T198584; FLIR Tools

-
- T198583; FLIR Tools+ (download card incl. license key)
 - T198585; FLIR VideoReport
 - DSW-10000; FLIR IR Camera Player
 - APP-10002; FLIR Tools Mobile (Android Application)
 - T198697; FLIR ResearchIR Max + HSDR 4 (hardware sec. dev.)
 - T199014; FLIR ResearchIR Max + HSDR 4 (printed license key)
 - T199044; FLIR ResearchIR Max + HSDR 4 Upgrade (printed license key)
 - T198696; FLIR ResearchIR Max 4 (hardware sec. dev.)
 - T199013; FLIR ResearchIR Max 4 (printed license key)
 - T199043; FLIR ResearchIR Max 4 Upgrade (printed license key)
 - T198731; FLIR ResearchIR Standard 4 (hardware sec. dev.)
 - T199012; FLIR ResearchIR Standard 4 (printed license key)
 - T199042; FLIR ResearchIR Standard 4 Upgrade (printed license key)
 - T199233; FLIR Atlas SDK for .NET
 - T199234; FLIR Atlas SDK for MATLAB
 - T198567; ThermoVision™ System Developers Kit Ver. 2.6
 - T198566; ThermoVision™ LabVIEW® Digital Toolkit Ver. 3.3

22.29 FLIR GF346 24° Fixed lens

P/N: 59802-0102

Rev.: 45202

General description	
<p>The FLIR GF346 is an infrared camera for optical gas imaging (OGI) that visualizes and pinpoints gas leaks of carbon monoxide (CO) and other harmful gases, without the need to shut down the operation. The portable camera also greatly improves operator safety, by detecting emissions at a safe distance, and helps to protect the environment by tracing leaks of environmentally harmful gases.</p> <p>CO is an industrial gas with applications in the steel industry and bulk chemicals manufacturing. It is also used for packaging systems for fresh meat and fish.</p>	
Benefits:	
<ul style="list-style-type: none"> Improved efficiency: The FLIR GF346 reduces revenue loss by pinpointing even small gas leaks quickly and efficiently, and from a distance. It also reduces the inspection time by allowing a broad area to be scanned rapidly and without the need to interrupt the industrial process. The wireless connectivity of the camera allows you to connect to smart phones or tablets for the wireless transfer of images or remote control of the camera. The FLIR GF346 can also be used for temperature measurement, which makes it even more useful for predictive maintenance. Increased worker safety: CO can be toxic to humans when encountered in higher concentrations. OGI allows gas leaks to be detected in a non-contact mode and from a safe distance. This reduces the risk of the user being exposed to invisible and highly toxic gases or explosive chemicals. With a FLIR GF346 gas imaging camera it is easy to scan areas of interest that are difficult to reach with conventional methods. The camera is ergonomically designed, with a bright LCD and tiltable viewfinder, which facilitates its use over a full working day. Protecting the environment: Several gases, such as CO, have a high global warming potential, and are usually governed by regulations. Even small leaks can be detected and documented using the FLIR GF346 camera. 	
<p>Detects the following gases: carbon monoxide, nitrous oxide, ketene, ethenone, butyl isocyanide, hexyl isocyanide, cyanogen bromide, acetonitrile, acetyl cyanide, chlorine isocyanate, bromine isocyanate, methyl thiocyanate, ethyl thiocyanate, chlorodimethylsilane, dichloromethylsilane, silane, germane, arsine.</p>	
Imaging and optical data	
IR resolution	320 × 240 pixels
Thermal sensitivity/NETD	<15 mK @ +30°C (+86°F)
Field of view (FOV)	24° × 18°
Minimum focus distance	0.3 m (1.0 ft.)
Focal length	23 mm (0.89 in.)
Lens identification	Automatic
F-number	1.5
Focus	Automatic (one touch) or manual (electric or on the lens)
Zoom	1–8× continuous, digital zoom
Digital image enhancement	Noise reduction filter, high sensitivity mode (HSM)
Detector data	
Detector type	Focal plane array (FPA), cooled InSb
Spectral range	Built-in cold band pass filter 4.52–4.67 μm
Detector pitch	30 μm

Detector data	
Sensor cooling	Stirling Microcooler (FLIR MC-3)
Detects following gases	Carbon Monoxide, Nitrous Oxide, Ketene, Ethene, Butyl Isocyanide, Hexyl Isocyanide, Cyanogen Bromide, Acetonitrile, Acetyl Cyanide, Chlorine Isocyanate, Bromine Isocyanate, Methyl Thiocyanate, Ethyl Thiocyanate, Chlorodimethylsilane, Dichloromethylsilane, Silane, Germane, Arsine
Electronics and data rate	
Full frame rate	60 Hz
Image presentation	
Display	Built-in widescreen, 4.3 in. LCD, 800 × 480 pixels
Viewfinder	Built-in, tiltable OLED, 800 × 480 pixels
Automatic image adjustment	Continuous/manual; linear or histogram based
Manual image adjustment	Level/span
Image presentation modes	
Image modes	IR image, visual image, high sensitivity mode (HSM)
Measurement	
Temperature range	-20°C to +300°C (-4°F to +572°F)
Accuracy	±1°C (±1.8°F) or ±1% of reading for temperature range 0°C to +300°C (+32°F to +572°F)
Measurement analysis	
Spotmeter	10
Area	5 boxes with max./min./average
Profile	1 live line (horizontal or vertical)
Difference temperature	Delta temperature between measurement functions or reference temperature
Reference temperature	Manually set or captured from any measurement function
Emissivity correction	Variable from 0.01 to 1.0 or selected from editable materials list
Reflected apparent temperature correction	Automatic, based on input of reflected temperature
Measurement corrections	Reflected temperature, distance, atmospheric transmission, humidity, external optics

Set-up	
Menu commands	Level, span Auto adjust continuous/manual/semi-automatic Zoom Palette Start/stop recording Store image Playback/recall image
Color palettes	Iron, Gray, Rainbow, Arctic, Lava, Rainbow HC
Set-up commands	1 programmable button, overlay recording mode, local adaptation of units, language, date and time formats
Storage of images	
Storage media	Removable SD or SDHC memory card , two card slots
Image storage capacity	> 1200 images (JPEG) with post process capability per GB on memory card
Image storage mode	IR/visual images Visual image can automatically be associated with corresponding IR image
Periodic image storage	Every 10 seconds up to 24 hours
File formats	Standard JPEG, 14 bit measurement data included
Geographic Information System	
GPS	Location data automatically added to every image from built-in GPS
Video recording in camera	
Radiometric IR video recording	*.seq video clips to memory card (7.5 and 15 Hz).
Non-radiometric IR video recording	MPEG4 (up to 60 minutes/clip) to memory card. Visual image can automatically be associated with corresponding recording of non-radiometric IR video.
Visual video recording	MPEG4 (25 minutes/clip) to memory card
Video streaming	
Radiometric IR video streaming	Full dynamic to PC using USB cable or to mobile devices using Wi-Fi. PC software capable of displaying the video stream include the following: <ul style="list-style-type: none"> • FLIR IR Camera Player • FLIR ResearchIR • FLIR Tools
Non-radiometric IR video streaming	RTP/MPEG4
Digital camera	
Built-in digital camera	3.2 Mpixels, auto focus, and two video lamps

Laser pointer	
Laser	Activated by dedicated button
Laser classification	Class 2
Laser type	Semiconductor AlGaInP diode laser, 1 mW, 635 nm (red)
USB	
USB	<ul style="list-style-type: none"> • USB-A: Connect external USB device • USB Mini-B: Data transfer to and from PC
USB, standard	USB Mini-B: 2.0 high speed
Composite video	
Video out	Digital video output (image)
Power system	
Battery type	Rechargeable Li ion battery
Battery voltage	7.2 V
Battery capacity	4.4 Ah
Battery operating time	> 3 hours at 25°C (+77°F) and typical use
Charging system	In camera (AC adapter or 12 V from a vehicle) or 2-bay charger
Charging time	2.5 h to 95% capacity, charging status indicated by LED's
External power operation	AC adapter 90–260 VAC, 50/60 Hz or 12 V from a vehicle (cable with standard plug, optional)
DC operation	10.8 to 16 V DC, polarity protected (proprietary protected)
Power	8.5 W typically
Start-up time	Typically 7 min. @ 25°C (+77°F)
Environmental data	
Operating temperature range	–20°C to +50°C (–4°F to +122°F)
Storage temperature range	–30°C to +60°C (–22°F to +140°F)
Humidity (operating and storage)	IEC 68-2-30/24 h 95% relative humidity +25°C to +40°C (+77°F to +104°F) (2 cycles)
Directives	<ul style="list-style-type: none"> • 73/23EEC • 2004/108/EC • 2002/95/EC • 2002/96/EC
EMC	<ul style="list-style-type: none"> • EN61000-6-4 (Emission) • EN61000-6-2 (Immunity) • FCC 47 CFR Part 15 class A (Emission) • EN 61 000-4-8, L5
Encapsulation	IP 54 (IEC 60529)
Shock	25 g (IEC 60068-2-27)
Vibration	2 g (IEC 60068-2-6)
Safety	Power supply: EN/UL/IEC 60950-1

Physical data	
Camera weight, excl. lens and battery	1.94 kg (4.27 lb.)
Camera weight, incl. lens and excl. battery	2.24 kg (4.94 lb.)
Camera weight, incl. lens and battery	2.48 kg (5.47 lb.)
Battery weight	0.24 kg (0.52 lb.)
Camera size, excl. lens (L × W × H)	284 × 169 × 161 mm (11.2 × 6.7 × 6.3 in.)
Cameras size, incl. lens (L × W × H)	306 × 169 × 161 mm (12.0 × 6.7 × 6.3 in.)
Battery size (L × W × H)	141 × 47 × 28 mm (5.5 × 1.8 × 1.1 in.)
Battery charger size (L × W × H)	158 × 122 × 25 mm (6.2 × 4.8 × 1.0 in.)
Tripod mounting	UNC ¼"-20
Housing material	Aluminum, magnesium
Grip material	TPE thermoplastic elastomers
Shipping information	
Packaging, type	Cardboard box
List of contents	<ul style="list-style-type: none"> • Infrared camera with lens • Battery charger • Battery, 2 ea. • Hard transport case • HDMI-DVI cable • HDMI-HDMI cable • Lens cap (mounted on lens) • Memory card • Power supply, incl. multi-plugs • Printed documentation • Shoulder strap • USB cable • Wi-Fi USB micro adapter (depending on CE and FCC regulations regarding wireless equipment for your country)
Packaging, weight	
Packaging, size	400 × 190 × 510 mm (15.7 × 7.5 × 20.1 in.)

Supplies & accessories:

- T197692; Battery charger, incl. power supply with multi plugs
- T910814; Power supply, incl. multi plugs
- T198511; Li-Ion Battery pack 7.4V 33Wh
- T199367ACC; Battery Li-ion 7.2 V, 4.4 Ah, 32 Wh
- T911650ACC; Memory card SD Card 8 GB
- 1910423; USB cable Std A <-> Mini-B
- T198509; Cigarette lighter adapter kit, 12 VDC, 1.2 m/3.9 ft.
- T910815ACC; HDMI to HDMI cable 1.5 m
- T910816ACC; HDMI to DVI cable 1.5 m
- T197555; Hard transport case for FLIR GF3xx-Series
- T951387; Wi-Fi USB micro adapter
- T198586; FLIR Reporter Professional (license only)
- T198584; FLIR Tools
- T198583; FLIR Tools+ (download card incl. license key)
- T198585; FLIR VideoReport
- DSW-10000; FLIR IR Camera Player
- APP-10002; FLIR Tools Mobile (Android Application)

- T198697; FLIR ResearchIR Max + HSDR 4 (hardware sec. dev.)
- T199014; FLIR ResearchIR Max + HSDR 4 (printed license key)
- T199044; FLIR ResearchIR Max + HSDR 4 Upgrade (printed license key)
- T198696; FLIR ResearchIR Max 4 (hardware sec. dev.)
- T199013; FLIR ResearchIR Max 4 (printed license key)
- T199043; FLIR ResearchIR Max 4 Upgrade (printed license key)
- T198731; FLIR ResearchIR Standard 4 (hardware sec. dev.)
- T199012; FLIR ResearchIR Standard 4 (printed license key)
- T199042; FLIR ResearchIR Standard 4 Upgrade (printed license key)
- T199233; FLIR Atlas SDK for .NET
- T199234; FLIR Atlas SDK for MATLAB
- T198567; ThermoVision™ System Developers Kit Ver. 2.6
- T198566; ThermoVision™ LabVIEW® Digital Toolkit Ver. 3.3

[See next page]

Camera housing

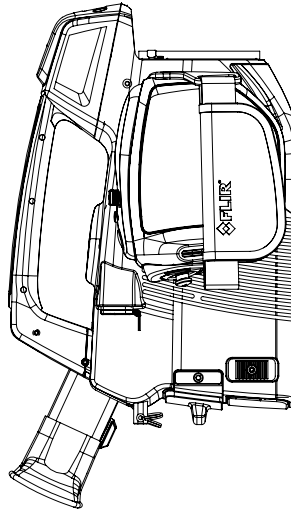
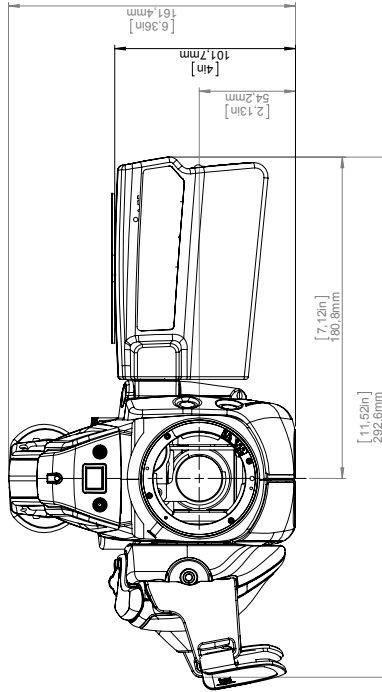
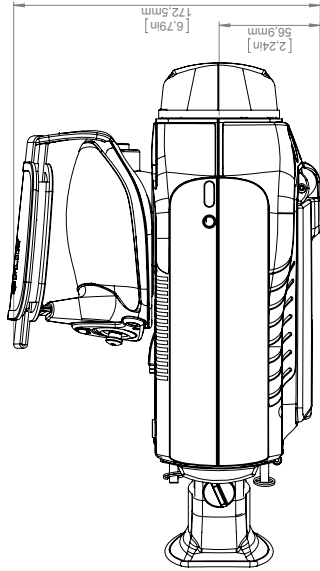
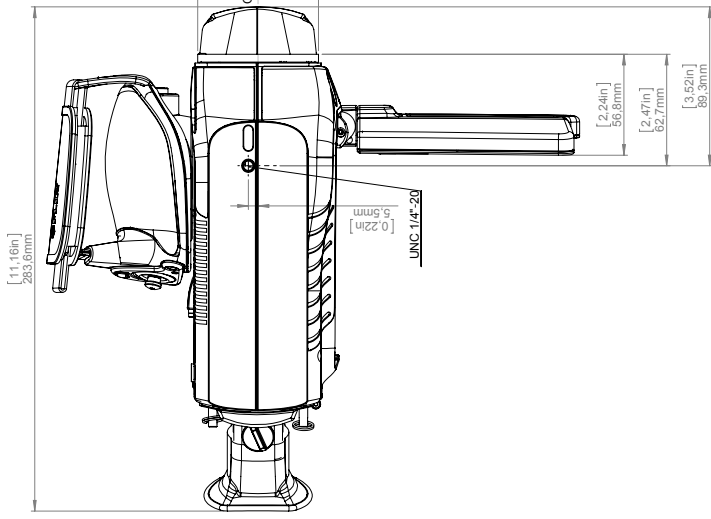
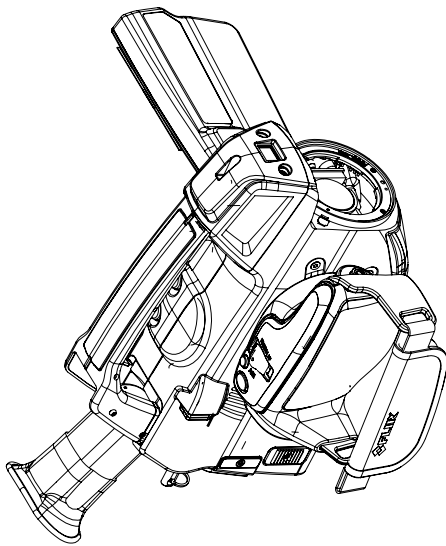

Modified	2013-02-18	Check	Drawn by	R&D Thermography	FLIR
Drawn by	R&D Thermography	Size	A3	Sheet	1(6)
Scale	1:2	Drawing No.	T-127603	Size	B
Basic dimension FLIR GF-3xx					

© 2012 FLIR Systems, Inc. All rights reserved worldwide. No part of this drawing may be reproduced, stored in a retrieval system, or transmitted in any form, or by any means, electronic, mechanical, photocopying, recording, or otherwise, without written permission from FLIR Systems, Inc. Specifications subject to change without further notice. Dimensional data is based on nominal values. Products may be subject to regional market considerations. License procedures may apply. Product may be subject to Export Regulations. Please refer to export@flir.com with any questions. Dimensional data is based on nominal values. Products may be subject to regional market considerations. License procedures may apply.

Camera with Lens IR f=23 mm (24°)
 Camera with Lens IR f=38 mm (14,5°)

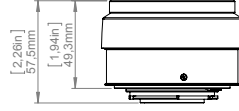
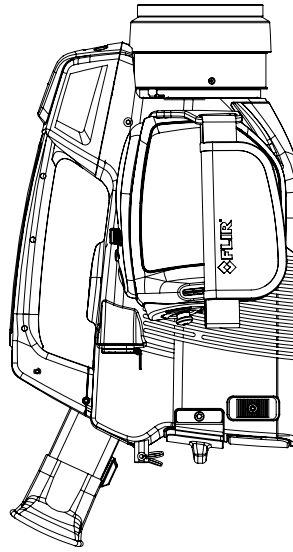
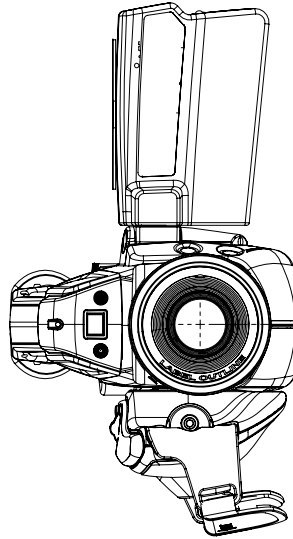
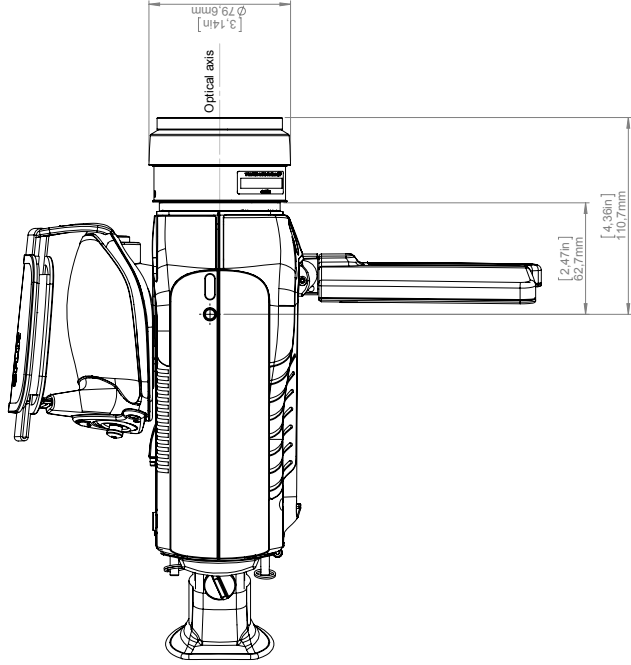

For additional dimensions see page 1

Model	2013-02-18	Check	Drawn by	R&D Thermography
Revision			Sheet	A3
			Scale	1:2
			Sheet	2(6)
			Drawing No.	T-127603
			Size	B



Basic dimension FLIR GF3xx

Camera with Lens IR f=92 mm (6°)

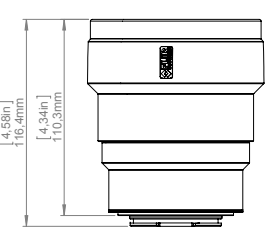
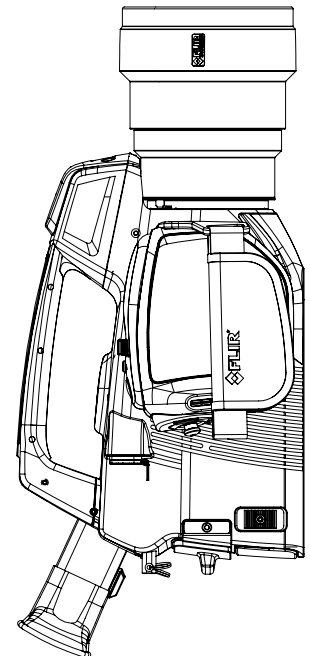
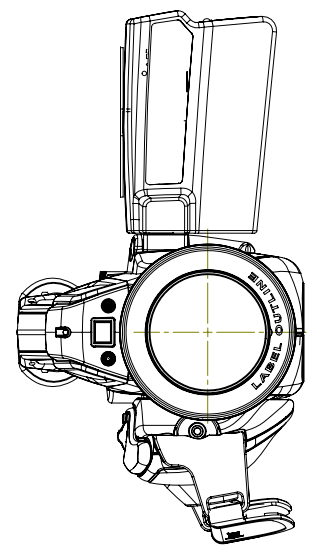
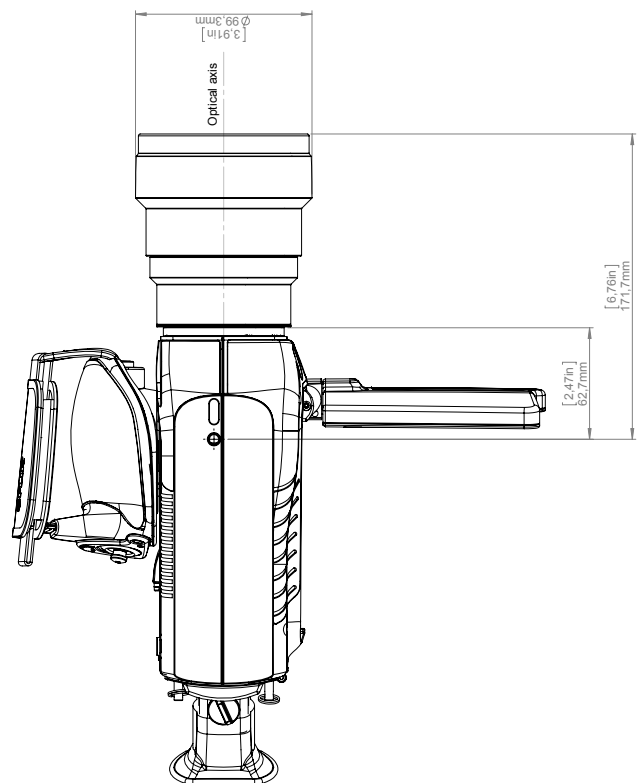
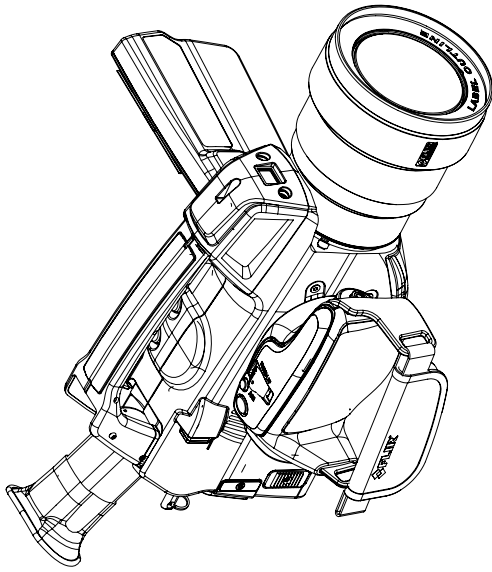

© 2012 FLIR Systems, Inc. All rights reserved worldwide. No part of this drawing may be reproduced, stored in a retrieval system, or transmitted in any form, or by any means, electronic, mechanical, photocopying, recording, or otherwise, without written permission from FLIR Systems, Inc. Specifications subject to change without further notice. Dimensional data is based on normal values. Products may be subject to regional market considerations. License procedures may apply. Product may be subject to US Export regulations. Please refer to appquestions@flir.com with any questions. Dimensional country: US (inches unless otherwise specified).

For additional dimensions see page 1

Model	2013-02-18	Check	Drawn by	R&D Thermography
Revision				
Sheet	A3			
Scale	1:2			
Sheet	3(6)			
Drawing No.	T-127603			
Size	B			

Basic dimension FLIR GF3xx

Camera with Lens f=23mm and extender

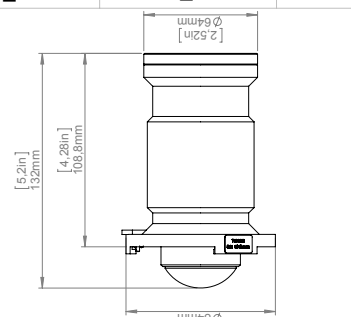
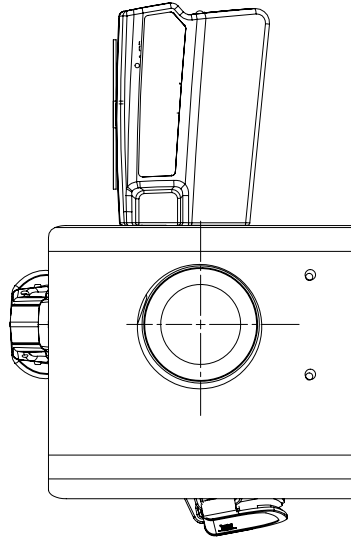
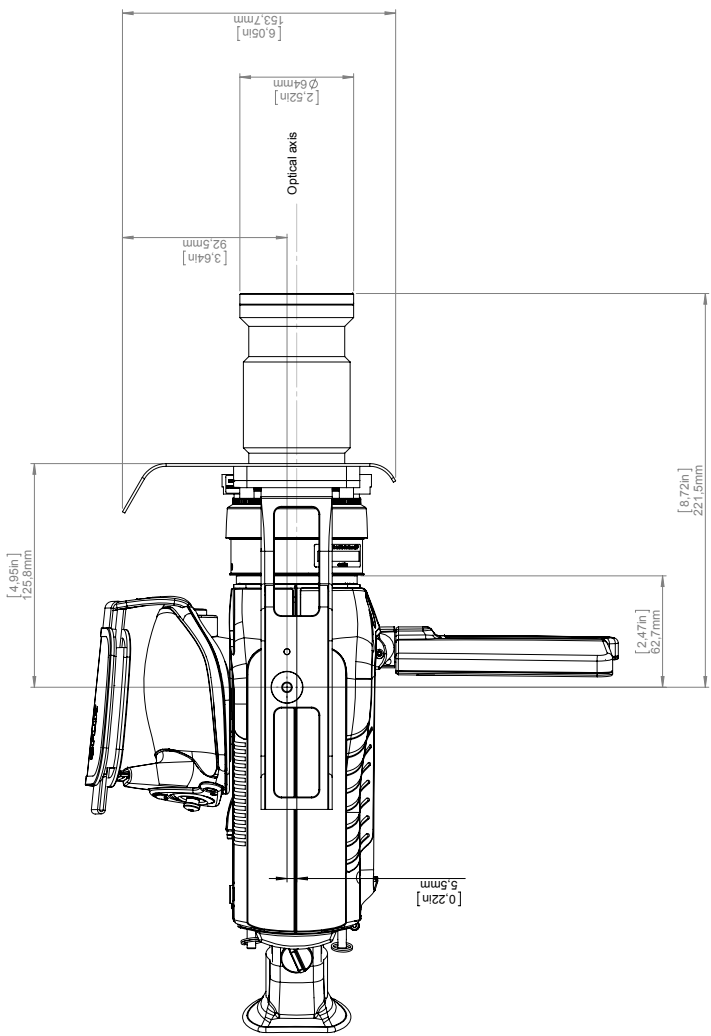

For additional dimensions see page 1

Model	2013-02-18	Check	Drawn by	R&D Thermography
Revision	01		Scale	1:2
Sheet	4(5)		Drawing No.	T-127603
Sheet	4(5)		Scale	1:2
Sheet	4(5)		Drawing No.	T-127603

Basic dimension FLIR GF3xx



Camera with Lens f=38mm and extender

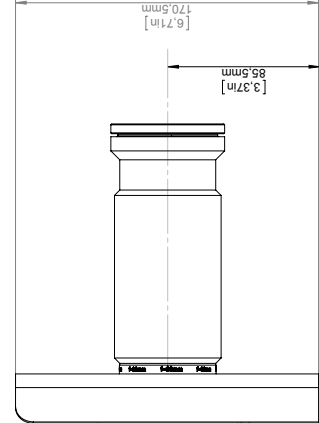
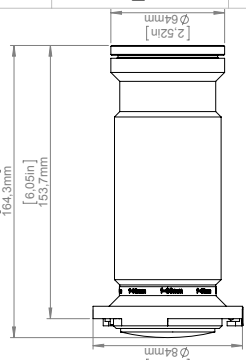
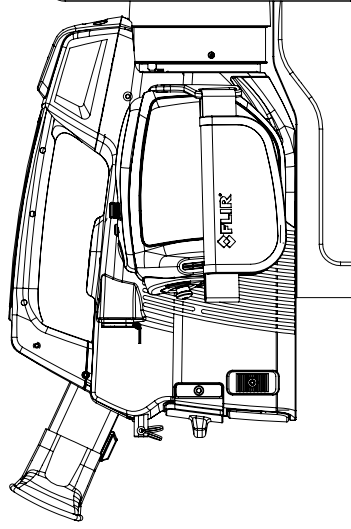
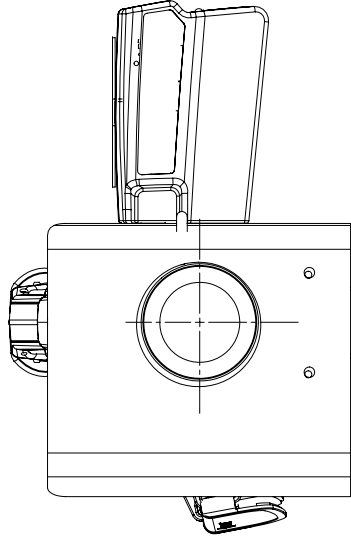
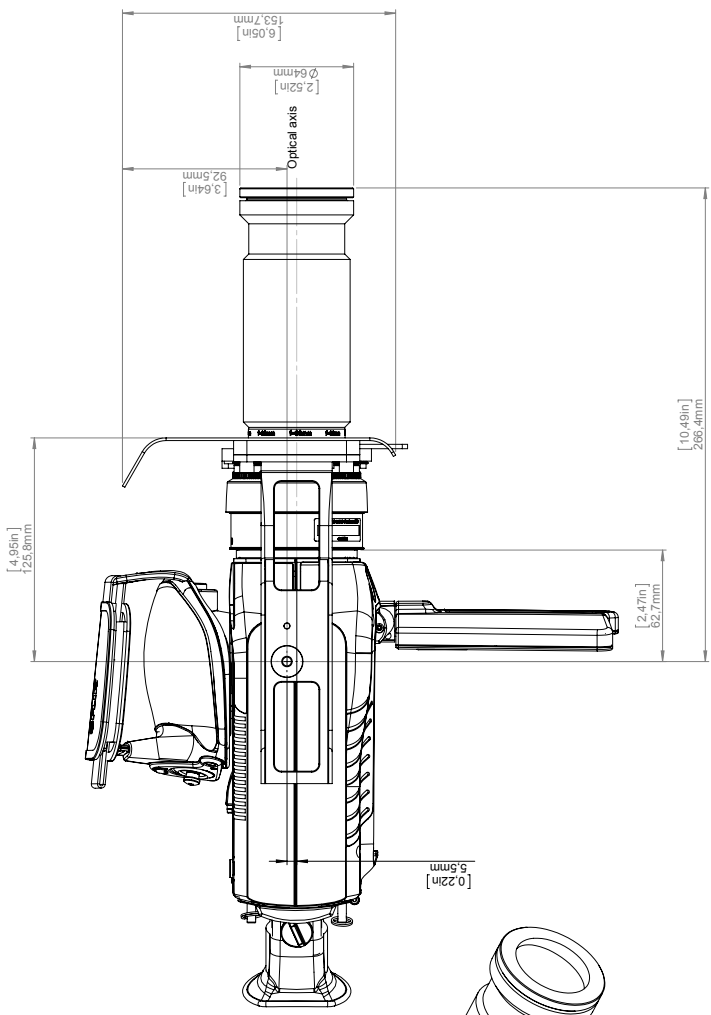

For additional dimensions see page 1

Model	2013-02-18	Check	Drawn by	R&D Thermography
Revision	01			
Sheet	A3			
Scale	1:2			
Sheet	5(6)			
Drawing No.	T-127603			

Basic dimension FLIR GF3xx



[See next page]

25.1 Camera housing, cables, and other items

25.1.1 Liquids

Use one of these liquids:

- Warm water
- A weak detergent solution

25.1.2 Equipment

A soft cloth

25.1.3 Procedure

Follow this procedure:

1. Soak the cloth in the liquid.
2. Twist the cloth to remove excess liquid.
3. Clean the part with the cloth.



CAUTION

Do not apply solvents or similar liquids to the camera, the cables, or other items. This can cause damage.

25.2 Infrared lens

25.2.1 Liquids

Use one of these liquids:

- A commercial lens cleaning liquid with more than 30% isopropyl alcohol.
- 96% ethyl alcohol (C_2H_5OH).

25.2.2 Equipment

Cotton wool



CAUTION

If you use a lens cleaning cloth it must be dry. Do not use a lens cleaning cloth with the liquids that are given in section 25.2.1 above. These liquids can cause material on the lens cleaning cloth to become loose. This material can have an unwanted effect on the surface of the lens.

25.2.3 Procedure

Follow this procedure:

1. Soak the cotton wool in the liquid.
2. Twist the cotton wool to remove excess liquid.
3. Clean the lens one time only and discard the cotton wool.



WARNING

Make sure that you read all applicable MSDS (Material Safety Data Sheets) and warning labels on containers before you use a liquid: the liquids can be dangerous.

**CAUTION**

- Be careful when you clean the infrared lens. The lens has a delicate anti-reflective coating.
- Do not clean the infrared lens too vigorously. This can damage the anti-reflective coating.

26.1 General

The microcooler is designed to provide maintenance-free operation for many thousands of hours. The microcooler contains pressurized helium gas.

After several thousand hours of operation the gas pressure decreases, and cooler service is required to restore cooler performance. The cooler also contains micro ball bearings, which may exhibit wear by becoming louder.

26.2 Signs to watch for

The FLIR Systems microcooler is equipped with a closed-loop speed regulator, which adjusts the cooler motor speed to regulate the detector temperature.





Typically, the cooler runs at maximum speed for 7–10 minutes (depending on model), and then slows to about 40% of maximum speed. As the gas pressure degrades, the motor continues at maximum speed for longer and longer periods to attain operating temperature







Eventually, as the helium pressure decreases, the motor will lose the ability to achieve and/or maintain operating temperature. When this occurs, the camera must be returned to FLIR Systems Customer Service Department for service.



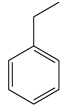

27.1 General

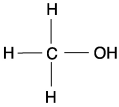

The FLIR GF3xx series range of cameras has been engineered and designed to detect various gases, such as hydrocarbons, sulfur hexafluoride, and carbon dioxide. Within the laboratory, FLIR Systems has tested numerous gases for detection at varying concentrations.

27.2 Gases that can be detected by FLIR GF300

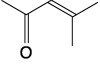
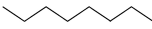
Common name	Molecular formula	Structural formula
1-Pentene	C_5H_{10}	
Benzene	C_6H_6	
Butane	C_4H_{10}	
Ethane	C_2H_6	
Ethanol	C_2H_6O	$ \begin{array}{c} \text{H} \quad \text{H} \\ \quad \\ \text{H}-\text{C}-\text{C}-\text{O}-\text{H} \\ \quad \\ \text{H} \quad \text{H} \end{array} $

Common name	Molecular formula	Structural formula
Ethylbenzene	C_8H_{10}	
Ethylene	C_2H_4	
Heptane	C_7H_{16}	
Hexane	C_6H_{14}	
Isoprene	C_5H_8	
<i>m</i> -Xylene	C_8H_{10}	
Methane	CH_4	



Common name	Molecular formula	Structural formula
Methanol	CH ₄ O	
Methyl ethyl ketone	C ₄ H ₈ O	
MIBK	C ₆ H ₁₀ O	
Octane	C ₈ H ₁₈	
Pentane	C ₅ H ₁₂	
Propane	C ₃ H ₈	

Common name	Molecular formula	Structural formula
Propylene	C ₃ H ₆	
Toluene	C ₇ H ₈	







27.3 Coolants that can be detected by FLIR GF304

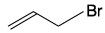
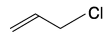
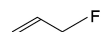
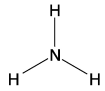
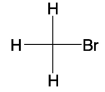
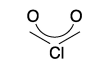
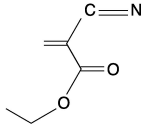

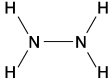

- R404A
- R407C
- R410A
- R134A
- R417A
- R422A
- R507A
- R143A
- R125
- R245fa

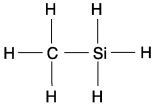
27.4 Gases that can be detected by FLIR GF306

Common name	Molecular formula	Structural formula
Acetic acid	C ₂ H ₄ O ₂	
Acetyl chloride	C ₂ H ₃ ClO	

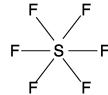

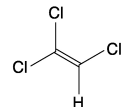
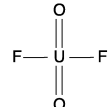

Common name	Molecular formula	Structural formula
Allyl bromide	C_3H_5Br	
Allyl chloride	C_3H_5Cl	
Allyl fluoride	C_3H_5F	
Ammonia	H_3N	
Bromomethane	CH_3Br	
Chlorine dioxide	ClO_2	
Ethyl cyanoacrylate	$C_6H_7NO_2$	

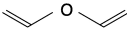





Common name	Molecular formula	Structural formula
Ethylene	C_2H_4	
Furan	C_4H_4O	
Hydrazine	H_4N_2	
Methyl ethyl ketone	C_4H_8O	
Methyl vinyl ketone	C_4H_6O	
Methylsilane	CH_6Si	
Propenal	C_3H_4O	



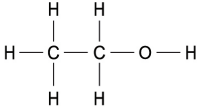
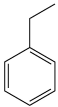

Common name	Molecular formula	Structural formula
Propylene	C_3H_6	
R 134a	N/A	N/A
Sulfur hexafluoride	SF_6	
Tetrahydrofuran	C_4H_8O	
Trichloroethylene	C_2HCl_3	
Uranyl fluoride	F_2O_2U	
Vinyl chloride	C_2H_3Cl	

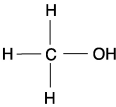

Common name	Molecular formula	Structural formula
Vinyl cyanide	C_3H_3N	
Vinyl ether	C_4H_6O	

27.5 Gases that can be detected by FLIR GF320

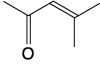
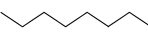
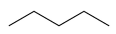
Common name	Molecular formula	Structural formula
1-Pentene	C_5H_{10}	
Benzene	C_6H_6	
Butane	C_4H_{10}	
Ethane	C_2H_6	

Common name	Molecular formula	Structural formula
Ethanol	C_2H_6O	
Ethylbenzene	C_8H_{10}	
Ethylene	C_2H_4	
Heptane	C_7H_{16}	
Hexane	C_6H_{14}	
Isoprene	C_5H_8	
<i>m</i> -Xylene	C_8H_{10}	

Common name	Molecular formula	Structural formula
Methane	CH ₄	
Methanol	CH ₄ O	
Methyl ethyl ketone	C ₄ H ₈ O	
MIBK	C ₆ H ₁₀ O	
Octane	C ₈ H ₁₈	
Pentane	C ₅ H ₁₂	
Propane	C ₃ H ₈	



Common name	Molecular formula	Structural formula
Propylene	C ₃ H ₆	
Toluene	C ₇ H ₈	

27.6 Gases that can be detected by FLIR GF343

Common name	Molecular formula	Structural formula
Carbon dioxide	CO ₂	O=C=O

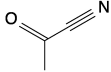
27.7 Gases that can be detected by FLIR GF346

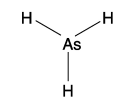
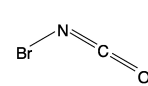
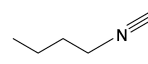
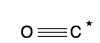
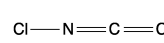
Common name	Molecular formula	Structural formula
Acetonitrile	C ₂ H ₃ N	
Acetyl cyanide	C ₃ H ₃ NO	

Common name	Molecular formula	Structural formula
Arsine	H ₃ As	
Bromine isocyanate	CBrNO	
Butyl isocyanide	C ₅ H ₉ N	
Carbon monoxide	CO	
Chlorine isocyanate	CCINO	
Chlorodimethylsilane	C ₂ H ₇ ClSi	
Cyanogen bromide	CBrN	

Common name	Molecular formula	Structural formula
Cyanogen chloride	CClN	
Dichloromethylsilane	CH ₄ Cl ₂ Si	
Ethenone	C ₂ H ₂ O	
Ethyl thiocyanate	C ₃ H ₅ NS	
Germane	H ₄ Ge	
Hexyl isocyanide	C ₇ H ₁₁ N	
Ketene	C ₂ H ₂ O	

Common name	Molecular formula	Structural formula
Methyl thiocyanate	C_2H_3NS	$N \equiv S$
Nitrous oxide	N_2O	$N \equiv N = O$
Silane	H_4Si	$\begin{array}{c} H \\ \\ H - Si - H \\ \\ H \end{array}$

Why do some gases absorb infrared energy?

From a simplistic mechanical point of view, molecules in a gas could be compared to weights (the balls in the figures below), connected together via springs. Depending on the number of atoms, their respective size and mass, the elastic constant of the springs, molecules may move in given directions, vibrate along an axis, rotate, twist, stretch, rock, wag, etc.

The simplest gas molecules are single atoms, like helium, neon or krypton. They have no way to vibrate or rotate, so they can only move by translation in one direction at a time.



Figure 28.1 Single atom

The next most complex category of molecules is diatomic, made of two atoms such as hydrogen (H_2), nitrogen (N_2) and oxygen (O_2). They have the ability to tumble around their axes in addition to translational motion.

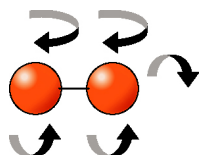

Figure 28.2 Two atoms

Then there are complex diatomic molecules, such as carbon dioxide (CO_2), methane (CH_4), sulfur hexafluoride (SF_6), and styrene ($C_6H_5CH=CH_2$) (these are just a few examples).



Figure 28.3 Simple mechanical model of carbon dioxide (CO_2), 3 atoms per molecule

This assumption is valid for multi-atomic molecules.

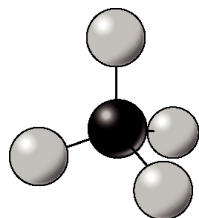

Figure 28.4 Methane (CH_4), 5 atoms per molecule

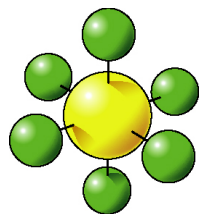

Figure 28.5 Sulfur hexafluoride (SF_6), 7 atoms per molecule

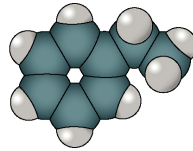

Figure 28.6 Molecular orbitals of Styrene ($C_6H_5CH=CH_2$), 16 atoms per molecule

Their increased degrees of freedom allow multiple rotational and vibrational transitions. Because they are built from multiple atoms, they can absorb and emit heat more effectively than simple molecules. Depending on the frequency of the transitions, some of them fall into energy ranges that are located in the infrared region where the infrared camera is sensitive.

Transition type	Frequency	Spectral range
Rotation of heavy molecules	10^9 – 10^{11} Hz	Microwaves, above 3 mm/0.118 in.
Rotation of light molecules and vibration of heavy molecules	10^{11} – 10^{13} Hz	Far infrared, between 30 μ m and 3 mm/0.118 in.
Vibration of light molecules. Rotation and vibration of the structure	10^{13} – 10^{14} Hz	Infrared, between 3 μ m and 30 μ m
Electronic transitions	10^{14} – 10^{16} Hz	UV–visible

In order for a molecule to absorb or emit a photon via a transition from one state to another, the molecule must have a dipole moment capable of briefly oscillating at the same frequency as the interacting photon. This quantum mechanical interaction allows the electromagnetic field energy of the photon to be captured or emitted by the molecule.

FLIR GF3xx series cameras take advantage of the absorbing and emitting nature of certain molecules, to visualize them in black or white in their native environments. The gas visualization contrast is a function of the gas concentration multiplied by the path length (CL), the temperature difference between to background (e.g. a wall) and the gas plume temperature.

FLIR GF3xx series focal plane arrays and optical systems are specifically tuned to very narrow spectral ranges, in the order of hundreds of nanometers, and are therefore selective. Only gases with sufficient signal strength active in the infrared region that is delimited by a narrow band pass filter can be detected.

Since the energy from the gases is very weak, all camera components are optimized to emit as little energy as possible. This is a very effective solution to provide a sufficient signal-to noise ratio. Hence, the filter itself is maintained at a cryogenic temperature.

Below, are the measured transmittance spectra of two gases, source: Pacific Northwest National Laboratory (PNNL):

- Benzene (C_6H_6), concentration length: CL=5000 ppmxm—absorbent in the MW region
- Sulfur hexafluoride (SF_6), concentration length: CL=50 ppmxm—absorbent in the LW region

Why do some gases absorb infrared energy?

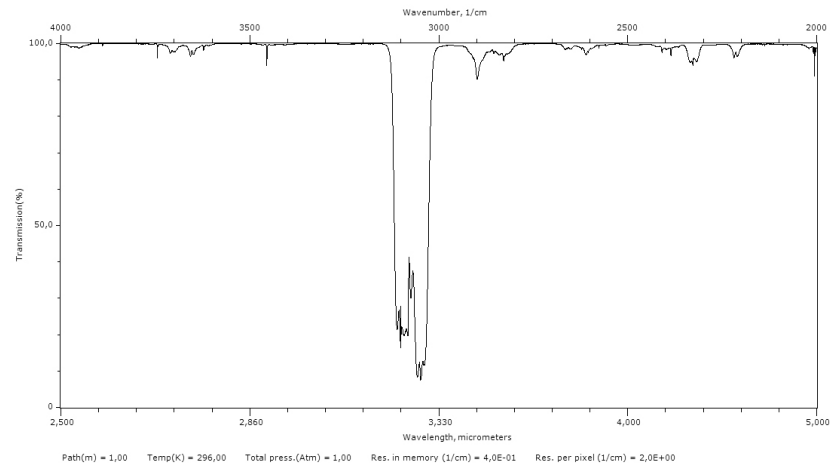

Figure 28.7 Benzene (C₆H₆). Strong absorption around 3.2 - 3.3 μm , CL=5000 ppmxm, Source: PNNL

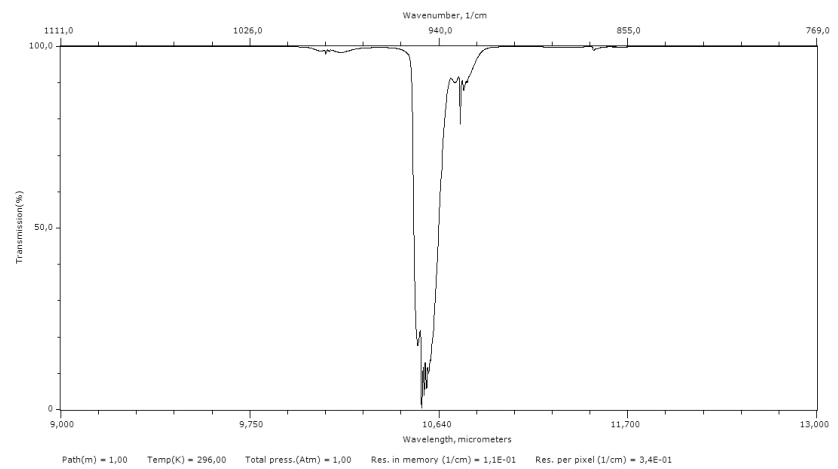

Figure 28.8 Sulfur hexafluoride (SF₆). Strong absorption around 10.6 μm , CL=50 ppmxm, Source: PNNL

About FLIR Systems

FLIR Systems was established in 1978 to pioneer the development of high-performance infrared imaging systems, and is the world leader in the design, manufacture, and marketing of thermal imaging systems for a wide variety of commercial, industrial, and government applications. Today, FLIR Systems embraces five major companies with outstanding achievements in infrared technology since 1958—the Swedish AGEMA Infrared Systems (formerly AGA Infrared Systems), the three United States companies Indigo Systems, FSI, and Inframetrics, and the French company Cedicp.

Since 2007, FLIR Systems has acquired several companies with world-leading expertise in sensor technologies:

- Exttech Instruments (2007)
- Ifara Tecnologías (2008)
- Salvador Imaging (2009)
- OmniTech Partners (2009)
- Directed Perception (2009)
- Raymarine (2010)
- ICx Technologies (2010)
- TackTick Marine Digital Instruments (2011)
- Aerius Photonics (2011)
- Lorex Technology (2012)
- Traficon (2012)
- MARSS (2013)
- DigitalOptics micro-optics business (2013)
- DVTEL (2015)
- Point Grey Research (2016)
- Prox Dynamics (2016)

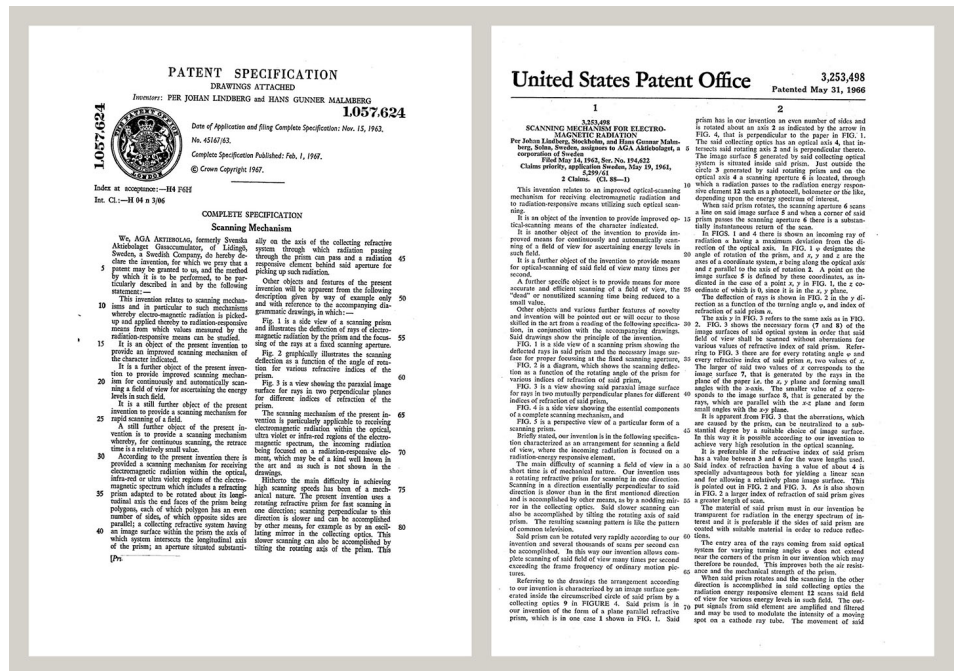

Figure 29.1 Patent documents from the early 1960s

FLIR Systems has three manufacturing plants in the United States (Portland, OR, Boston, MA, Santa Barbara, CA) and one in Sweden (Stockholm). Since 2007 there is also a

manufacturing plant in Tallinn, Estonia. Direct sales offices in Belgium, Brazil, China, France, Germany, Great Britain, Hong Kong, Italy, Japan, Korea, Sweden, and the USA— together with a worldwide network of agents and distributors—support our international customer base.

FLIR Systems is at the forefront of innovation in the infrared camera industry. We anticipate market demand by constantly improving our existing cameras and developing new ones. The company has set milestones in product design and development such as the introduction of the first battery-operated portable camera for industrial inspections, and the first uncooled infrared camera, to mention just two innovations.



Figure 29.2 1969: Thermovision Model 661. The camera weighed approximately 25 kg (55 lb.), the oscilloscope 20 kg (44 lb.), and the tripod 15 kg (33 lb.). The operator also needed a 220 VAC generator set, and a 10 L (2.6 US gallon) jar with liquid nitrogen. To the left of the oscilloscope the Polaroid attachment (6 kg (13 lb.)) can be seen.



Figure 29.3 2015: FLIR One, an accessory to iPhone and Android mobile phones. Weight: 90 g (3.2 oz.).

FLIR Systems manufactures all vital mechanical and electronic components of the camera systems itself. From detector design and manufacturing, to lenses and system electronics, to final testing and calibration, all production steps are carried out and supervised by our own engineers. The in-depth expertise of these infrared specialists ensures the accuracy and reliability of all vital components that are assembled into your infrared camera.

29.1 More than just an infrared camera

At FLIR Systems we recognize that our job is to go beyond just producing the best infrared camera systems. We are committed to enabling all users of our infrared camera systems to work more productively by providing them with the most powerful camera–software combination. Especially tailored software for predictive maintenance, R & D, and process monitoring is developed in-house. Most software is available in a wide variety of languages.

We support all our infrared cameras with a wide variety of accessories to adapt your equipment to the most demanding infrared applications.

29.2 Sharing our knowledge

Although our cameras are designed to be very user-friendly, there is a lot more to thermography than just knowing how to handle a camera. Therefore, FLIR Systems has founded the Infrared Training Center (ITC), a separate business unit, that provides certified training courses. Attending one of the ITC courses will give you a truly hands-on learning experience.

The staff of the ITC are also there to provide you with any application support you may need in putting infrared theory into practice.

29.3 Supporting our customers

FLIR Systems operates a worldwide service network to keep your camera running at all times. If you discover a problem with your camera, local service centers have all the equipment and expertise to solve it within the shortest possible time. Therefore, there is no need to send your camera to the other side of the world or to talk to someone who does not speak your language.

Term	Definition
Absorption and emission ¹	The capacity or ability of an object to absorb incident radiated energy is always the same as the capacity to emit its own energy as radiation
Apparent temperature	uncompensated reading from an infrared instrument, containing all radiation incident on the instrument, regardless of its sources ²
Color palette	assigns different colors to indicate specific levels of apparent temperature. Palettes can provide high or low contrast, depending on the colors used in them
Conduction	direct transfer of thermal energy from molecule to molecule, caused by collisions between the molecules
Convection	heat transfer mode where a fluid is brought into motion, either by gravity or another force, thereby transferring heat from one place to another
Diagnostics	examination of symptoms and syndromes to determine the nature of faults or failures ³
Direction of heat transfer ⁴	Heat will spontaneously flow from hotter to colder, thereby transferring thermal energy from one place to another ⁵
Emissivity	ratio of the power radiated by real bodies to the power that is radiated by a blackbody at the same temperature and at the same wavelength ⁶
Energy conservation ⁷	The sum of the total energy contents in a closed system is constant
Exitant radiation	radiation that leaves the surface of an object, regardless of its original sources
Heat	thermal energy that is transferred between two objects (systems) due to their difference in temperature
Heat transfer rate ⁸	The heat transfer rate under steady state conditions is directly proportional to the thermal conductivity of the object, the cross-sectional area of the object through which the heat flows, and the temperature difference between the two ends of the object. It is inversely proportional to the length, or thickness, of the object ⁹
Incident radiation	radiation that strikes an object from its surroundings
IR thermography	process of acquisition and analysis of thermal information from non-contact thermal imaging devices
Isotherm	replaces certain colors in the scale with a contrasting color. It marks an interval of equal apparent temperature ¹⁰

1. Kirchhoff's law of thermal radiation.
2. Based on ISO 18434-1:2008 (en).
3. Based on ISO 13372:2004 (en).
4. 2nd law of thermodynamics.
5. This is a consequence of the 2nd law of thermodynamics, the law itself is more complicated.
6. Based on ISO 16714-3:2016 (en).
7. 1st law of thermodynamics.
8. Fourier's law.
9. This is the one-dimensional form of Fourier's law, valid for steady-state conditions.
10. Based on ISO 18434-1:2008 (en)

Term	Definition
Qualitative thermography	thermography that relies on the analysis of thermal patterns to reveal the existence of and to locate the position of anomalies ¹¹
Quantitative thermography	thermography that uses temperature measurement to determine the seriousness of an anomaly, in order to establish repair priorities ¹¹
Radiative heat transfer	Heat transfer by the emission and absorption of thermal radiation
Reflected apparent temperature	apparent temperature of the environment that is reflected by the target into the IR camera ¹²
Spatial resolution	ability of an IR camera to resolve small objects or details
Temperature	measure of the average kinetic energy of the molecules and atoms that make up the substance
Thermal energy	total kinetic energy of the molecules that make up the object ¹³
Thermal gradient	gradual change in temperature over distance ¹²
Thermal tuning	process of putting the colors of the image on the object of analysis, in order to maximize contrast

11. Based on ISO 10878-2013 (en).

12. Based on ISO 16714-3:2016 (en).

13. Thermal energy is part of the internal energy of an object.

31.1 Introduction

Calibration of a thermal camera is a prerequisite for temperature measurement. The calibration provides the relationship between the input signal and the physical quantity that the user wants to measure. However, despite its widespread and frequent use, the term “calibration” is often misunderstood and misused. Local and national differences as well as translation-related issues create additional confusion.

Unclear terminology can lead to difficulties in communication and erroneous translations, and subsequently to incorrect measurements due to misunderstandings and, in the worst case, even to lawsuits.

31.2 Definition—what is calibration?

The International Bureau of Weights and Measures¹⁴ defines *calibration*¹⁵ in the following way:

an operation that, under specified conditions, in a first step, establishes a relation between the quantity values with measurement uncertainties provided by measurement standards and corresponding indications with associated measurement uncertainties and, in a second step, uses this information to establish a relation for obtaining a measurement result from an indication.

The calibration itself may be expressed in different formats: this can be a statement, calibration function, calibration diagram¹⁶, calibration curve¹⁷, or calibration table.

Often, the first step alone in the above definition is perceived and referred to as being “calibration.” However, this is not (always) sufficient.

Considering the calibration procedure of a thermal camera, the first step establishes the relation between emitted radiation (the quantity value) and the electrical output signal (the indication). This first step of the calibration procedure consists of obtaining a homogeneous (or uniform) response when the camera is placed in front of an extended source of radiation.

As we know the temperature of the reference source emitting the radiation, in the second step the obtained output signal (the indication) can be related to the reference source’s temperature (measurement result). The second step includes drift measurement and compensation.

To be correct, calibration of a thermal camera is, strictly, not expressed through temperature. Thermal cameras are sensitive to infrared radiation: therefore, at first you obtain a radiance correspondence, then a relationship between radiance and temperature. For bolometer cameras used by non-R&D customers, radiance is not expressed: only the temperature is provided.

31.3 Camera calibration at FLIR Systems

Without calibration, an infrared camera would not be able to measure either radiance or temperature. At FLIR Systems, the calibration of uncooled microbolometer cameras with a

14. <http://www.bipm.org/en/about-us/> [Retrieved 2017-01-31.]

15. <http://jcgim.bipm.org/vim/en/2.39.html> [Retrieved 2017-01-31.]

16. <http://jcgim.bipm.org/vim/en/4.30.html> [Retrieved 2017-01-31.]

17. <http://jcgim.bipm.org/vim/en/4.31.html> [Retrieved 2017-01-31.]

measurement capability is carried out during both production and service. Cooled cameras with photon detectors are often calibrated by the user with special software. With this type of software, in theory, common handheld uncooled thermal cameras could be calibrated by the user too. However, as this software is not suitable for reporting purposes, most users do not have it. Non-measuring devices that are used for imaging only do not need temperature calibration. Sometimes this is also reflected in camera terminology when talking about infrared or thermal imaging cameras compared with thermography cameras, where the latter are the measuring devices.

The calibration information, no matter if the calibration is done by FLIR Systems or the user, is stored in calibration curves, which are expressed by mathematical functions. As radiation intensity changes with both temperature and the distance between the object and the camera, different curves are generated for different temperature ranges and exchangeable lenses.

31.4 The differences between a calibration performed by a user and that performed directly at FLIR Systems

First, the reference sources that FLIR Systems uses are themselves calibrated and traceable. This means, at each FLIR Systems site performing calibration, that the sources are controlled by an independent national authority. The camera calibration certificate is confirmation of this. It is proof that not only has the calibration been performed by FLIR Systems but that it has also been carried out using calibrated references. Some users own or have access to accredited reference sources, but they are very few in number.

Second, there is a technical difference. When performing a user calibration, the result is often (but not always) not drift compensated. This means that the values do not take into account a possible change in the camera's output when the camera's internal temperature varies. This yields a larger uncertainty. Drift compensation uses data obtained in climate-controlled chambers. All FLIR Systems cameras are drift compensated when they are first delivered to the customer and when they are recalibrated by FLIR Systems service departments.

31.5 Calibration, verification and adjustment

A common misconception is to confuse *calibration* with *verification* or *adjustment*. Indeed, calibration is a prerequisite for *verification*, which provides confirmation that specified requirements are met. Verification provides objective evidence that a given item fulfills specified requirements. To obtain the verification, defined temperatures (emitted radiation) of calibrated and traceable reference sources are measured. The measurement results, including the deviation, are noted in a table. The verification certificate states that these measurement results meet specified requirements. Sometimes, companies or organizations offer and market this verification certificate as a "calibration certificate."

Proper verification—and by extension calibration and/or recalibration—can only be achieved when a validated protocol is respected. The process is more than placing the camera in front of blackbodies and checking if the camera output (as temperature, for instance) corresponds to the original calibration table. It is often forgotten that a camera is not sensitive to temperature but to radiation. Furthermore, a camera is an *imaging* system, not just a single sensor. Consequently, if the optical configuration allowing the camera to "collect" radiance is poor or misaligned, then the "verification" (or calibration or recalibration) is worthless.

For instance, one has to ensure that the distance between the blackbody and the camera as well as the diameter of the blackbody cavity are chosen so as to reduce stray radiation and the size-of-source effect.

To summarize: a validated protocol must comply with the physical laws for *radiance*, and not only those for temperature.

Calibration is also a prerequisite for *adjustment*, which is the set of operations carried out on a measuring system such that the system provides prescribed indications corresponding to given values of quantities to be measured, typically obtained from measurement standards. Simplified, adjustment is a manipulation that results in instruments that measure correctly within their specifications. In everyday language, the term “calibration” is widely used instead of “adjustment” for measuring devices.

31.6 Non-uniformity correction

When the thermal camera displays “Calibrating...” it is adjusting for the deviation in response of each individual detector element (pixel). In thermography, this is called a “non-uniformity correction” (NUC). It is an offset update, and the gain remains unchanged.

The European standard EN 16714-3, Non-destructive Testing—Thermographic Testing—Part 3: Terms and Definitions, defines an NUC as “Image correction carried out by the camera software to compensate for different sensitivities of detector elements and other optical and geometrical disturbances.”

During the NUC (the offset update), a shutter (internal flag) is placed in the optical path, and all the detector elements are exposed to the same amount of radiation originating from the shutter. Therefore, in an ideal situation, they should all give the same output signal. However, each individual element has its own response, so the output is not uniform. This deviation from the ideal result is calculated and used to mathematically perform an image correction, which is essentially a correction of the displayed radiation signal. Some cameras do not have an internal flag. In this case, the offset update must be performed manually using special software and an external uniform source of radiation.

An NUC is performed, for example, at start-up, when changing a measurement range, or when the environment temperature changes. Some cameras also allow the user to trigger it manually. This is useful when you have to perform a critical measurement with as little image disturbance as possible.

31.7 Thermal image adjustment (thermal tuning)

Some people use the term “image calibration” when adjusting the thermal contrast and brightness in the image to enhance specific details. During this operation, the temperature interval is set in such a way that all available colors are used to show only (or mainly) the temperatures in the region of interest. The correct term for this manipulation is “thermal image adjustment” or “thermal tuning”, or, in some languages, “thermal image optimization.” You must be in manual mode to undertake this, otherwise the camera will set the lower and upper limits of the displayed temperature interval automatically to the coldest and hottest temperatures in the scene.

32.1 Introduction

An infrared camera measures and images the emitted infrared radiation from an object. The fact that radiation is a function of object surface temperature makes it possible for the camera to calculate and display this temperature.

However, the radiation measured by the camera does not only depend on the temperature of the object but is also a function of the emissivity. Radiation also originates from the surroundings and is reflected in the object. The radiation from the object and the reflected radiation will also be influenced by the absorption of the atmosphere.

To measure temperature accurately, it is therefore necessary to compensate for the effects of a number of different radiation sources. This is done on-line automatically by the camera. The following object parameters must, however, be supplied for the camera:

- The emissivity of the object
- The reflected apparent temperature
- The distance between the object and the camera
- The relative humidity
- Temperature of the atmosphere

32.2 Emissivity

The most important object parameter to set correctly is the emissivity which, in short, is a measure of how much radiation is emitted from the object, compared to that from a perfect blackbody of the same temperature.

Normally, object materials and surface treatments exhibit emissivity ranging from approximately 0.1 to 0.95. A highly polished (mirror) surface falls below 0.1, while an oxidized or painted surface has a higher emissivity. Oil-based paint, regardless of color in the visible spectrum, has an emissivity over 0.9 in the infrared. Human skin exhibits an emissivity 0.97 to 0.98.

Non-oxidized metals represent an extreme case of perfect opacity and high reflexivity, which does not vary greatly with wavelength. Consequently, the emissivity of metals is low – only increasing with temperature. For non-metals, emissivity tends to be high, and decreases with temperature.

32.2.1 Finding the emissivity of a sample

32.2.1.1 Step 1: Determining reflected apparent temperature

Use one of the following two methods to determine reflected apparent temperature:

32.2.1.1.1 Method 1: Direct method

Follow this procedure:

1. Look for possible reflection sources, considering that the incident angle = reflection angle ($a = b$).

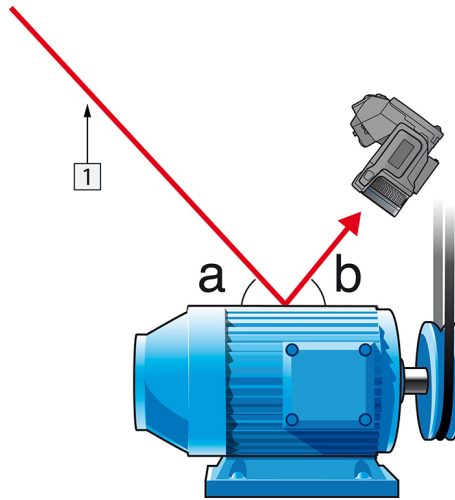

Figure 32.1 1 = Reflection source

2. If the reflection source is a spot source, modify the source by obstructing it using a piece of cardboard.

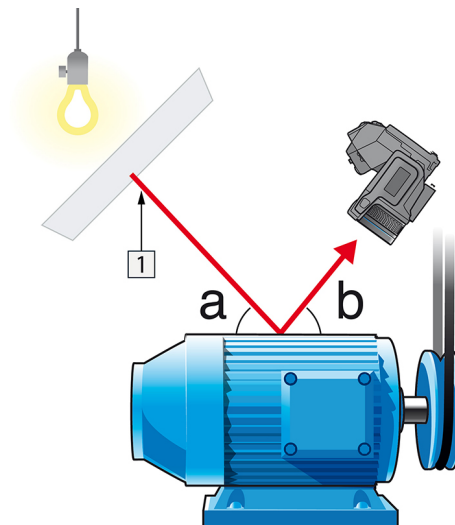

Figure 32.2 1 = Reflection source

3. Measure the radiation intensity (= apparent temperature) from the reflection source using the following settings:

- Emissivity: 1.0
- D_{obj} : 0

You can measure the radiation intensity using one of the following two methods:

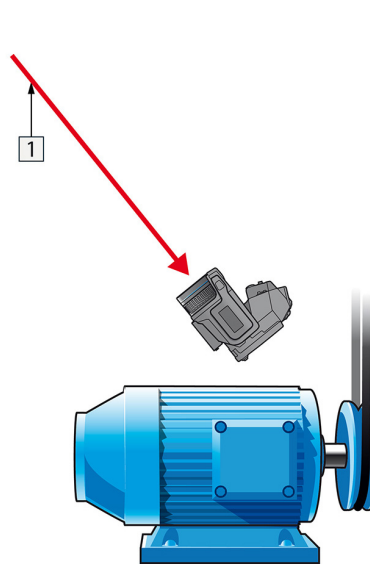

Figure 32.3 1 = Reflection source

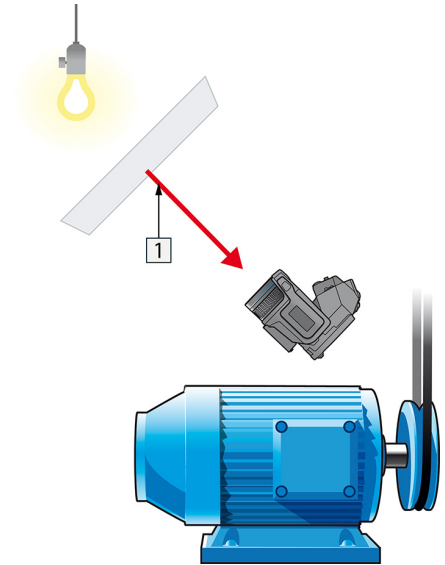

Figure 32.4 1 = Reflection source

You can not use a thermocouple to measure reflected apparent temperature, because a thermocouple measures *temperature*, but apparent temperature is *radiation intensity*.

32.2.1.1.2 Method 2: Reflector method

Follow this procedure:

1. Crumble up a large piece of aluminum foil.
2. Uncrumble the aluminum foil and attach it to a piece of cardboard of the same size.
3. Put the piece of cardboard in front of the object you want to measure. Make sure that the side with aluminum foil points to the camera.
4. Set the emissivity to 1.0.

5. Measure the apparent temperature of the aluminum foil and write it down. The foil is considered a perfect reflector, so its apparent temperature equals the reflected apparent temperature from the surroundings.

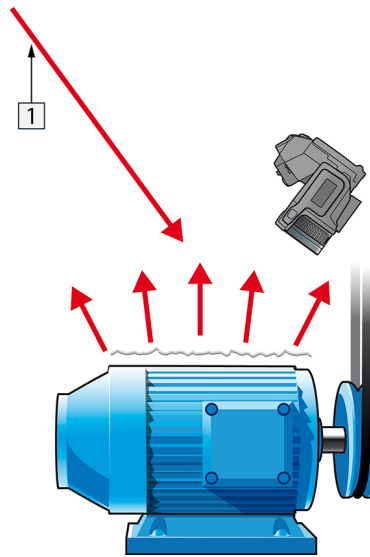

Figure 32.5 Measuring the apparent temperature of the aluminum foil.

32.2.1.2 Step 2: Determining the emissivity

Follow this procedure:

1. Select a place to put the sample.
2. Determine and set reflected apparent temperature according to the previous procedure.
3. Put a piece of electrical tape with known high emissivity on the sample.
4. Heat the sample at least 20 K above room temperature. Heating must be reasonably even.
5. Focus and auto-adjust the camera, and freeze the image.
6. Adjust *Level* and *Span* for best image brightness and contrast.
7. Set emissivity to that of the tape (usually 0.97).
8. Measure the temperature of the tape using one of the following measurement functions:
 - *Isotherm* (helps you to determine both the temperature and how evenly you have heated the sample)
 - *Spot* (simpler)
 - *Box Avg* (good for surfaces with varying emissivity).
9. Write down the temperature.
10. Move your measurement function to the sample surface.
11. Change the emissivity setting until you read the same temperature as your previous measurement.
12. Write down the emissivity.

Note

- Avoid forced convection
- Look for a thermally stable surrounding that will not generate spot reflections
- Use high quality tape that you know is not transparent, and has a high emissivity you are certain of
- This method assumes that the temperature of your tape and the sample surface are the same. If they are not, your emissivity measurement will be wrong.

32.3 Reflected apparent temperature

This parameter is used to compensate for the radiation reflected in the object. If the emissivity is low and the object temperature relatively far from that of the reflected it will be important to set and compensate for the reflected apparent temperature correctly.

32.4 Distance

The distance is the distance between the object and the front lens of the camera. This parameter is used to compensate for the following two facts:

- That radiation from the target is absorbed by the atmosphere between the object and the camera.
- That radiation from the atmosphere itself is detected by the camera.

32.5 Relative humidity

The camera can also compensate for the fact that the transmittance is also dependent on the relative humidity of the atmosphere. To do this set the relative humidity to the correct value. For short distances and normal humidity the relative humidity can normally be left at a default value of 50%.

32.6 Other parameters

In addition, some cameras and analysis programs from FLIR Systems allow you to compensate for the following parameters:

- Atmospheric temperature – *i.e.* the temperature of the atmosphere between the camera and the target
- External optics temperature – *i.e.* the temperature of any external lenses or windows used in front of the camera
- External optics transmittance – *i.e.* the transmission of any external lenses or windows used in front of the camera

Before the year 1800, the existence of the infrared portion of the electromagnetic spectrum wasn't even suspected. The original significance of the infrared spectrum, or simply 'the infrared' as it is often called, as a form of heat radiation is perhaps less obvious today than it was at the time of its discovery by Herschel in 1800.

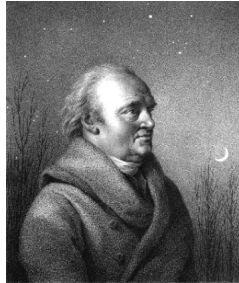

Figure 33.1 Sir William Herschel (1738–1822)

The discovery was made accidentally during the search for a new optical material. Sir William Herschel – Royal Astronomer to King George III of England, and already famous for his discovery of the planet Uranus – was searching for an optical filter material to reduce the brightness of the sun's image in telescopes during solar observations. While testing different samples of colored glass which gave similar reductions in brightness he was intrigued to find that some of the samples passed very little of the sun's heat, while others passed so much heat that he risked eye damage after only a few seconds' observation.

Herschel was soon convinced of the necessity of setting up a systematic experiment, with the objective of finding a single material that would give the desired reduction in brightness as well as the maximum reduction in heat. He began the experiment by actually repeating Newton's prism experiment, but looking for the heating effect rather than the visual distribution of intensity in the spectrum. He first blackened the bulb of a sensitive mercury-in-glass thermometer with ink, and with this as his radiation detector he proceeded to test the heating effect of the various colors of the spectrum formed on the top of a table by passing sunlight through a glass prism. Other thermometers, placed outside the sun's rays, served as controls.

As the blackened thermometer was moved slowly along the colors of the spectrum, the temperature readings showed a steady increase from the violet end to the red end. This was not entirely unexpected, since the Italian researcher, Landriani, in a similar experiment in 1777 had observed much the same effect. It was Herschel, however, who was the first to recognize that there must be a point where the heating effect reaches a maximum, and that measurements confined to the visible portion of the spectrum failed to locate this point.



Figure 33.2 Marsilio Landriani (1746–1815)

Moving the thermometer into the dark region beyond the red end of the spectrum, Herschel confirmed that the heating continued to increase. The maximum point, when he found it, lay well beyond the red end – in what is known today as the ‘infrared wavelengths’.

When Herschel revealed his discovery, he referred to this new portion of the electromagnetic spectrum as the ‘thermometrical spectrum’. The radiation itself he sometimes referred to as ‘dark heat’, or simply ‘the invisible rays’. Ironically, and contrary to popular opinion, it wasn't Herschel who originated the term ‘infrared’. The word only began to appear in print around 75 years later, and it is still unclear who should receive credit as the originator.

Herschel's use of glass in the prism of his original experiment led to some early controversies with his contemporaries about the actual existence of the infrared wavelengths. Different investigators, in attempting to confirm his work, used various types of glass indiscriminately, having different transparencies in the infrared. Through his later experiments, Herschel was aware of the limited transparency of glass to the newly-discovered thermal radiation, and he was forced to conclude that optics for the infrared would probably be doomed to the use of reflective elements exclusively (i.e. plane and curved mirrors). Fortunately, this proved to be true only until 1830, when the Italian investigator, Melloni, made his great discovery that naturally occurring rock salt (NaCl) – which was available in large enough natural crystals to be made into lenses and prisms – is remarkably transparent to the infrared. The result was that rock salt became the principal infrared optical material, and remained so for the next hundred years, until the art of synthetic crystal growing was mastered in the 1930's.



Figure 33.3 Macedonio Melloni (1798–1854)

Thermometers, as radiation detectors, remained unchallenged until 1829, the year Nobili invented the thermocouple. (Herschel's own thermometer could be read to $0.2\text{ }^{\circ}\text{C}$ ($0.036\text{ }^{\circ}\text{F}$), and later models were able to be read to $0.05\text{ }^{\circ}\text{C}$ ($0.09\text{ }^{\circ}\text{F}$)). Then a breakthrough occurred; Melloni connected a number of thermocouples in series to form the first thermopile. The new device was at least 40 times as sensitive as the best thermometer of the day for detecting heat radiation – capable of detecting the heat from a person standing three meters away.

The first so-called ‘heat-picture’ became possible in 1840, the result of work by Sir John Herschel, son of the discoverer of the infrared and a famous astronomer in his own right. Based upon the differential evaporation of a thin film of oil when exposed to a heat pattern focused upon it, the thermal image could be seen by reflected light where the interference effects of the oil film made the image visible to the eye. Sir John also managed to obtain a primitive record of the thermal image on paper, which he called a ‘thermograph’.



Figure 33.4 Samuel P. Langley (1834–1906)

The improvement of infrared-detector sensitivity progressed slowly. Another major breakthrough, made by Langley in 1880, was the invention of the bolometer. This consisted of a thin blackened strip of platinum connected in one arm of a Wheatstone bridge circuit upon which the infrared radiation was focused and to which a sensitive galvanometer responded. This instrument is said to have been able to detect the heat from a cow at a distance of 400 meters.

An English scientist, Sir James Dewar, first introduced the use of liquefied gases as cooling agents (such as liquid nitrogen with a temperature of -196°C (-320.8°F)) in low temperature research. In 1892 he invented a unique vacuum insulating container in which it is possible to store liquefied gases for entire days. The common 'thermos bottle', used for storing hot and cold drinks, is based upon his invention.

Between the years 1900 and 1920, the inventors of the world 'discovered' the infrared. Many patents were issued for devices to detect personnel, artillery, aircraft, ships – and even icebergs. The first operating systems, in the modern sense, began to be developed during the 1914–18 war, when both sides had research programs devoted to the military exploitation of the infrared. These programs included experimental systems for enemy intrusion/detection, remote temperature sensing, secure communications, and 'flying torpedo' guidance. An infrared search system tested during this period was able to detect an approaching airplane at a distance of 1.5 km (0.94 miles), or a person more than 300 meters (984 ft.) away.

The most sensitive systems up to this time were all based upon variations of the bolometer idea, but the period between the two wars saw the development of two revolutionary new infrared detectors: the image converter and the photon detector. At first, the image converter received the greatest attention by the military, because it enabled an observer for the first time in history to literally 'see in the dark'. However, the sensitivity of the image converter was limited to the near infrared wavelengths, and the most interesting military targets (i.e. enemy soldiers) had to be illuminated by infrared search beams. Since this involved the risk of giving away the observer's position to a similarly-equipped enemy observer, it is understandable that military interest in the image converter eventually faded.

The tactical military disadvantages of so-called 'active' (i.e. search beam-equipped) thermal imaging systems provided impetus following the 1939–45 war for extensive secret military infrared-research programs into the possibilities of developing 'passive' (no search beam) systems around the extremely sensitive photon detector. During this period, military secrecy regulations completely prevented disclosure of the status of infrared-imaging technology. This secrecy only began to be lifted in the middle of the 1950's, and from that time adequate thermal-imaging devices finally began to be available to civilian science and industry.

34.1 Introduction

The subjects of infrared radiation and the related technique of thermography are still new to many who will use an infrared camera. In this section the theory behind thermography will be given.

34.2 The electromagnetic spectrum

The electromagnetic spectrum is divided arbitrarily into a number of wavelength regions, called *bands*, distinguished by the methods used to produce and detect the radiation. There is no fundamental difference between radiation in the different bands of the electromagnetic spectrum. They are all governed by the same laws and the only differences are those due to differences in wavelength.

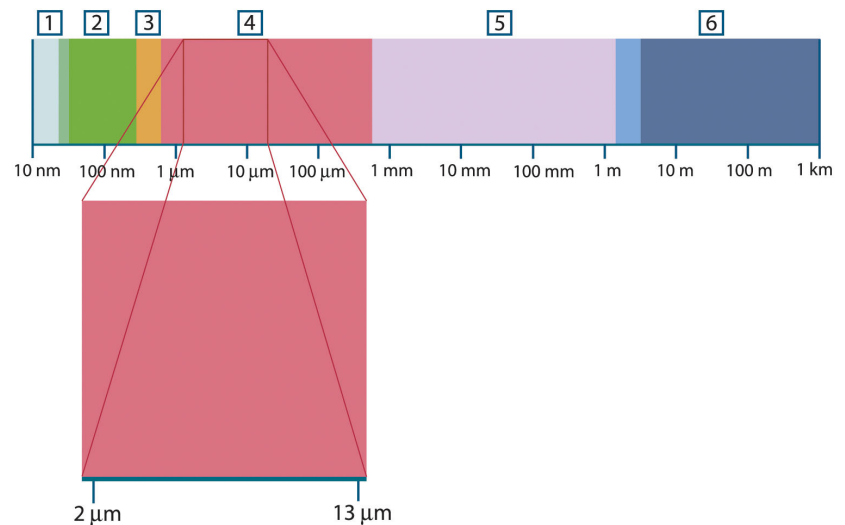

Figure 34.1 The electromagnetic spectrum. 1: X-ray; 2: UV; 3: Visible; 4: IR; 5: Microwaves; 6: Radiowaves.

Thermography makes use of the infrared spectral band. At the short-wavelength end the boundary lies at the limit of visual perception, in the deep red. At the long-wavelength end it merges with the microwave radio wavelengths, in the millimeter range.

The infrared band is often further subdivided into four smaller bands, the boundaries of which are also arbitrarily chosen. They include: the *near infrared* (0.75–3 μm), the *middle infrared* (3–6 μm), the *far infrared* (6–15 μm) and the *extreme infrared* (15–100 μm). Although the wavelengths are given in μm (micrometers), other units are often still used to measure wavelength in this spectral region, e.g. nanometer (nm) and Ångström (Å).

The relationships between the different wavelength measurements is:

$$10\,000\ \text{Å} = 1\,000\ \text{nm} = 1\ \mu = 1\ \mu\text{m}$$

34.3 Blackbody radiation

A blackbody is defined as an object which absorbs all radiation that impinges on it at any wavelength. The apparent misnomer *black* relating to an object emitting radiation is explained by Kirchhoff's Law (after *Gustav Robert Kirchhoff*, 1824–1887), which states that a body capable of absorbing all radiation at any wavelength is equally capable in the emission of radiation.

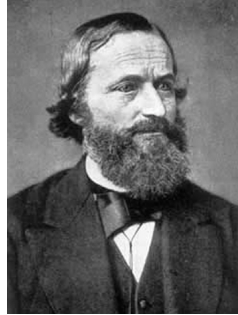

Figure 34.2 Gustav Robert Kirchhoff (1824–1887)

The construction of a blackbody source is, in principle, very simple. The radiation characteristics of an aperture in an isotherm cavity made of an opaque absorbing material represents almost exactly the properties of a blackbody. A practical application of the principle to the construction of a perfect absorber of radiation consists of a box that is light tight except for an aperture in one of the sides. Any radiation which then enters the hole is scattered and absorbed by repeated reflections so only an infinitesimal fraction can possibly escape. The blackness which is obtained at the aperture is nearly equal to a blackbody and almost perfect for all wavelengths.

By providing such an isothermal cavity with a suitable heater it becomes what is termed a *cavity radiator*. An isothermal cavity heated to a uniform temperature generates blackbody radiation, the characteristics of which are determined solely by the temperature of the cavity. Such cavity radiators are commonly used as sources of radiation in temperature reference standards in the laboratory for calibrating thermographic instruments, such as a FLIR Systems camera for example.

If the temperature of blackbody radiation increases to more than 525°C (977°F), the source begins to be visible so that it appears to the eye no longer black. This is the incipient red heat temperature of the radiator, which then becomes orange or yellow as the temperature increases further. In fact, the definition of the so-called *color temperature* of an object is the temperature to which a blackbody would have to be heated to have the same appearance.

Now consider three expressions that describe the radiation emitted from a blackbody.

34.3.1 Planck's law



Figure 34.3 Max Planck (1858–1947)

Max Planck (1858–1947) was able to describe the spectral distribution of the radiation from a blackbody by means of the following formula:

$$W_{\lambda b} = \frac{2\pi hc^2}{\lambda^5 \left(e^{\frac{hc}{\lambda kT}} - 1 \right)} \times 10^{-6} [\text{Watt} / \text{m}^2, \mu\text{m}]$$

where:

$W_{\lambda b}$	Blackbody spectral radiant emittance at wavelength λ .
c	Velocity of light = 3×10^8 m/s
h	Planck's constant = 6.6×10^{-34} Joule sec.
k	Boltzmann's constant = 1.4×10^{-23} Joule/K.
T	Absolute temperature (K) of a blackbody.
λ	Wavelength (μm).

Note The factor 10^{-6} is used since spectral emittance in the curves is expressed in Watt/ $\text{m}^2, \mu\text{m}$.

Planck's formula, when plotted graphically for various temperatures, produces a family of curves. Following any particular Planck curve, the spectral emittance is zero at $\lambda = 0$, then increases rapidly to a maximum at a wavelength λ_{max} and after passing it approaches zero again at very long wavelengths. The higher the temperature, the shorter the wavelength at which maximum occurs.

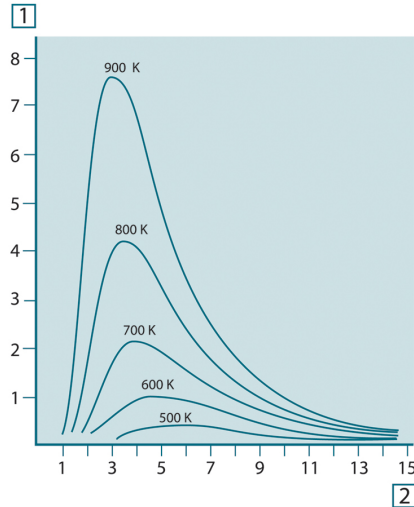

Figure 34.4 Blackbody spectral radiant emittance according to Planck's law, plotted for various absolute temperatures. 1: Spectral radiant emittance ($\text{W}/\text{cm}^2 \times 10^3(\mu\text{m})$); 2: Wavelength (μm)

34.3.2 Wien's displacement law

By differentiating Planck's formula with respect to λ , and finding the maximum, we have:

$$\lambda_{\text{max}} = \frac{2898}{T} [\mu\text{m}]$$

This is Wien's formula (after *Wilhelm Wien*, 1864–1928), which expresses mathematically the common observation that colors vary from red to orange or yellow as the temperature of a thermal radiator increases. The wavelength of the color is the same as the wavelength calculated for λ_{max} . A good approximation of the value of λ_{max} for a given blackbody temperature is obtained by applying the rule-of-thumb $3\,000/T \mu\text{m}$. Thus, a very hot star such as Sirius (11 000 K), emitting bluish-white light, radiates with the peak of spectral radiant emittance occurring within the invisible ultraviolet spectrum, at wavelength $0.27 \mu\text{m}$.

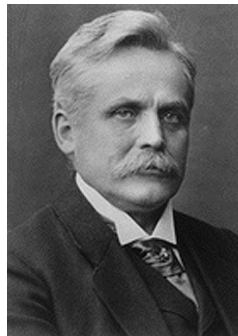

Figure 34.5 Wilhelm Wien (1864–1928)

The sun (approx. 6 000 K) emits yellow light, peaking at about $0.5 \mu\text{m}$ in the middle of the visible light spectrum.

At room temperature (300 K) the peak of radiant emittance lies at 9.7 μm , in the far infrared, while at the temperature of liquid nitrogen (77 K) the maximum of the almost insignificant amount of radiant emittance occurs at 38 μm , in the extreme infrared wavelengths.

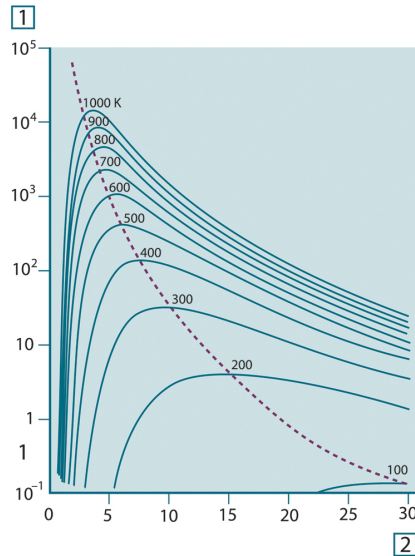

Figure 34.6 Planckian curves plotted on semi-log scales from 100 K to 1000 K. The dotted line represents the locus of maximum radiant emittance at each temperature as described by Wien's displacement law. 1: Spectral radiant emittance (W/cm^2 (μm)); 2: Wavelength (μm).

34.3.3 Stefan-Boltzmann's law

By integrating Planck's formula from $\lambda = 0$ to $\lambda = \infty$, we obtain the total radiant emittance (W_b) of a blackbody:

$$W_b = \sigma T^4 \text{ [Watt}/\text{m}^2]$$

This is the Stefan-Boltzmann formula (after *Josef Stefan*, 1835–1893, and *Ludwig Boltzmann*, 1844–1906), which states that the total emissive power of a blackbody is proportional to the fourth power of its absolute temperature. Graphically, W_b represents the area below the Planck curve for a particular temperature. It can be shown that the radiant emittance in the interval $\lambda = 0$ to λ_{max} is only 25% of the total, which represents about the amount of the sun's radiation which lies inside the visible light spectrum.



Figure 34.7 Josef Stefan (1835–1893), and Ludwig Boltzmann (1844–1906)

Using the Stefan-Boltzmann formula to calculate the power radiated by the human body, at a temperature of 300 K and an external surface area of approx. 2 m², we obtain 1 kW. This power loss could not be sustained if it were not for the compensating absorption of radiation from surrounding surfaces, at room temperatures which do not vary too drastically from the temperature of the body – or, of course, the addition of clothing.

34.3.4 Non-blackbody emitters

So far, only blackbody radiators and blackbody radiation have been discussed. However, real objects almost never comply with these laws over an extended wavelength region – although they may approach the blackbody behavior in certain spectral intervals. For example, a certain type of white paint may appear perfectly *white* in the visible light spectrum, but becomes distinctly *gray* at about 2 μm, and beyond 3 μm it is almost *black*.

There are three processes which can occur that prevent a real object from acting like a blackbody: a fraction of the incident radiation α may be absorbed, a fraction ρ may be reflected, and a fraction τ may be transmitted. Since all of these factors are more or less wavelength dependent, the subscript λ is used to imply the spectral dependence of their definitions. Thus:

- The spectral absorptance α_λ = the ratio of the spectral radiant power absorbed by an object to that incident upon it.
- The spectral reflectance ρ_λ = the ratio of the spectral radiant power reflected by an object to that incident upon it.
- The spectral transmittance τ_λ = the ratio of the spectral radiant power transmitted through an object to that incident upon it.

The sum of these three factors must always add up to the whole at any wavelength, so we have the relation:

$$\alpha_\lambda + \rho_\lambda + \tau_\lambda = 1$$

For opaque materials $\tau_\lambda = 0$ and the relation simplifies to:

$$\varepsilon_\lambda + \rho_\lambda = 1$$

Another factor, called the emissivity, is required to describe the fraction ε of the radiant emittance of a blackbody produced by an object at a specific temperature. Thus, we have the definition:

The spectral emissivity ε_λ = the ratio of the spectral radiant power from an object to that from a blackbody at the same temperature and wavelength.

Expressed mathematically, this can be written as the ratio of the spectral emittance of the object to that of a blackbody as follows:

$$\varepsilon_\lambda = \frac{W_{\lambda o}}{W_{\lambda b}}$$

Generally speaking, there are three types of radiation source, distinguished by the ways in which the spectral emittance of each varies with wavelength.

- A blackbody, for which $\varepsilon_\lambda = \varepsilon = 1$
- A graybody, for which $\varepsilon_\lambda = \varepsilon = \text{constant less than 1}$
- A selective radiator, for which ε varies with wavelength

According to Kirchoff's law, for any material the spectral emissivity and spectral absorptance of a body are equal at any specified temperature and wavelength. That is:

$$\varepsilon_\lambda = \alpha_\lambda$$

From this we obtain, for an opaque material (since $\alpha_\lambda + \rho_\lambda = 1$):

$$\varepsilon_\lambda + \rho_\lambda = 1$$

For highly polished materials ε_λ approaches zero, so that for a perfectly reflecting material (*i.e.* a perfect mirror) we have:

$$\rho_\lambda = 1$$

For a graybody radiator, the Stefan-Boltzmann formula becomes:

$$W = \varepsilon\sigma T^4 \text{ [Watt/m}^2\text{]}$$

This states that the total emissive power of a graybody is the same as a blackbody at the same temperature reduced in proportion to the value of ε from the graybody.

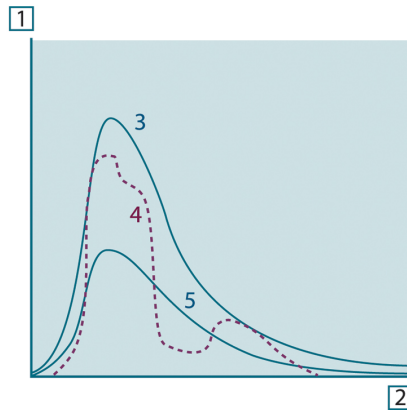

Figure 34.8 Spectral radiant emittance of three types of radiators. 1: Spectral radiant emittance; 2: Wavelength; 3: Blackbody; 4: Selective radiator; 5: Graybody.

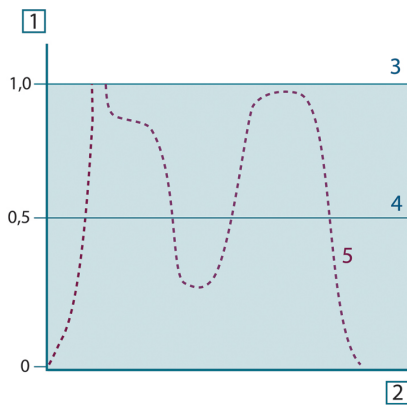

Figure 34.9 Spectral emissivity of three types of radiators. 1: Spectral emissivity; 2: Wavelength; 3: Blackbody; 4: Graybody; 5: Selective radiator.

34.4 Infrared semi-transparent materials

Consider now a non-metallic, semi-transparent body – let us say, in the form of a thick flat plate of plastic material. When the plate is heated, radiation generated within its volume must work its way toward the surfaces through the material in which it is partially absorbed. Moreover, when it arrives at the surface, some of it is reflected back into the interior. The back-reflected radiation is again partially absorbed, but some of it arrives at the other surface, through which most of it escapes; part of it is reflected back again. Although the progressive reflections become weaker and weaker they must all be added up when the total emittance of the plate is sought. When the resulting geometrical series is summed, the effective emissivity of a semi-transparent plate is obtained as:

$$\varepsilon_{\lambda} = \frac{(1 - \rho_{\lambda})(1 - \tau_{\lambda})}{1 - \rho_{\lambda}\tau_{\lambda}}$$

When the plate becomes opaque this formula is reduced to the single formula:

$$\varepsilon_{\lambda} = 1 - \rho_{\lambda}$$

This last relation is a particularly convenient one, because it is often easier to measure reflectance than to measure emissivity directly.

As already mentioned, when viewing an object, the camera receives radiation not only from the object itself. It also collects radiation from the surroundings reflected via the object surface. Both these radiation contributions become attenuated to some extent by the atmosphere in the measurement path. To this comes a third radiation contribution from the atmosphere itself.

This description of the measurement situation, as illustrated in the figure below, is so far a fairly true description of the real conditions. What has been neglected could for instance be sun light scattering in the atmosphere or stray radiation from intense radiation sources outside the field of view. Such disturbances are difficult to quantify, however, in most cases they are fortunately small enough to be neglected. In case they are not negligible, the measurement configuration is likely to be such that the risk for disturbance is obvious, at least to a trained operator. It is then his responsibility to modify the measurement situation to avoid the disturbance e.g. by changing the viewing direction, shielding off intense radiation sources etc.

Accepting the description above, we can use the figure below to derive a formula for the calculation of the object temperature from the calibrated camera output.

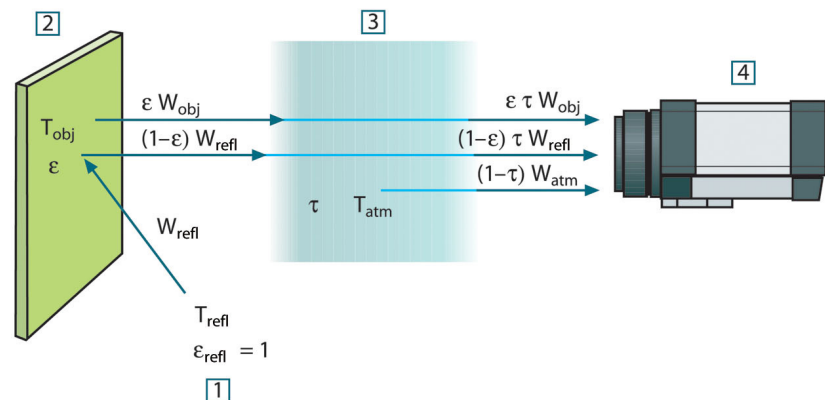

Figure 35.1 A schematic representation of the general thermographic measurement situation. 1: Surroundings; 2: Object; 3: Atmosphere; 4: Camera

Assume that the received radiation power W from a blackbody source of temperature T_{source} on short distance generates a camera output signal U_{source} that is proportional to the power input (power linear camera). We can then write (Equation 1):

$$U_{\text{source}} = CW(T_{\text{source}})$$

or, with simplified notation:

$$U_{\text{source}} = CW_{\text{source}}$$

where C is a constant.

Should the source be a graybody with emittance ϵ , the received radiation would consequently be $\epsilon W_{\text{source}}$.

We are now ready to write the three collected radiation power terms:

1. *Emission from the object* = $\epsilon \tau W_{\text{obj}}$, where ϵ is the emittance of the object and τ is the transmittance of the atmosphere. The object temperature is T_{obj} .

2. *Reflected emission from ambient sources* = $(1 - \varepsilon)\tau W_{\text{refl}}$, where $(1 - \varepsilon)$ is the reflectance of the object. The ambient sources have the temperature T_{refl} .
It has here been assumed that the temperature T_{refl} is the same for all emitting surfaces within the halfsphere seen from a point on the object surface. This is of course sometimes a simplification of the true situation. It is, however, a necessary simplification in order to derive a workable formula, and T_{refl} can – at least theoretically – be given a value that represents an efficient temperature of a complex surrounding.

Note also that we have assumed that the emittance for the surroundings = 1. This is correct in accordance with Kirchhoff's law: All radiation impinging on the surrounding surfaces will eventually be absorbed by the same surfaces. Thus the emittance = 1. (Note though that the latest discussion requires the complete sphere around the object to be considered.)

3. *Emission from the atmosphere* = $(1 - \tau)\tau W_{\text{atm}}$, where $(1 - \tau)$ is the emittance of the atmosphere. The temperature of the atmosphere is T_{atm} .

The total received radiation power can now be written (Equation 2):

$$W_{\text{tot}} = \varepsilon\tau W_{\text{obj}} + (1 - \varepsilon)\tau W_{\text{refl}} + (1 - \tau)W_{\text{atm}}$$

We multiply each term by the constant C of Equation 1 and replace the CW products by the corresponding U according to the same equation, and get (Equation 3):

$$U_{\text{tot}} = \varepsilon\tau U_{\text{obj}} + (1 - \varepsilon)\tau U_{\text{refl}} + (1 - \tau)U_{\text{atm}}$$

Solve Equation 3 for U_{obj} (Equation 4):

$$U_{\text{obj}} = \frac{1}{\varepsilon\tau} U_{\text{tot}} - \frac{1 - \varepsilon}{\varepsilon} U_{\text{refl}} - \frac{1 - \tau}{\varepsilon\tau} U_{\text{atm}}$$

This is the general measurement formula used in all the FLIR Systems thermographic equipment. The voltages of the formula are:

Table 35.1 Voltages

U_{obj}	Calculated camera output voltage for a blackbody of temperature T_{obj} i.e. a voltage that can be directly converted into true requested object temperature.
U_{tot}	Measured camera output voltage for the actual case.
U_{refl}	Theoretical camera output voltage for a blackbody of temperature T_{refl} according to the calibration.
U_{atm}	Theoretical camera output voltage for a blackbody of temperature T_{atm} according to the calibration.

The operator has to supply a number of parameter values for the calculation:

- the object emittance ε ,
- the relative humidity,
- T_{atm}
- object distance (D_{obj})
- the (effective) temperature of the object surroundings, or the reflected ambient temperature T_{refl} , and
- the temperature of the atmosphere T_{atm}

This task could sometimes be a heavy burden for the operator since there are normally no easy ways to find accurate values of emittance and atmospheric transmittance for the

actual case. The two temperatures are normally less of a problem provided the surroundings do not contain large and intense radiation sources.

A natural question in this connection is: How important is it to know the right values of these parameters? It could though be of interest to get a feeling for this problem already here by looking into some different measurement cases and compare the relative magnitudes of the three radiation terms. This will give indications about when it is important to use correct values of which parameters.

The figures below illustrates the relative magnitudes of the three radiation contributions for three different object temperatures, two emittances, and two spectral ranges: SW and LW. Remaining parameters have the following fixed values:

- $\tau = 0.88$
- $T_{refl} = +20^{\circ}\text{C} (+68^{\circ}\text{F})$
- $T_{atm} = +20^{\circ}\text{C} (+68^{\circ}\text{F})$

It is obvious that measurement of low object temperatures are more critical than measuring high temperatures since the 'disturbing' radiation sources are relatively much stronger in the first case. Should also the object emittance be low, the situation would be still more difficult.

We have finally to answer a question about the importance of being allowed to use the calibration curve above the highest calibration point, what we call extrapolation. Imagine that we in a certain case measure $U_{tot} = 4.5$ volts. The highest calibration point for the camera was in the order of 4.1 volts, a value unknown to the operator. Thus, even if the object happened to be a blackbody, i.e. $U_{obj} = U_{tot}$, we are actually performing extrapolation of the calibration curve when converting 4.5 volts into temperature.

Let us now assume that the object is not black, it has an emittance of 0.75, and the transmittance is 0.92. We also assume that the two second terms of Equation 4 amount to 0.5 volts together. Computation of U_{obj} by means of Equation 4 then results in $U_{obj} = 4.5 / 0.75 / 0.92 - 0.5 = 6.0$. This is a rather extreme extrapolation, particularly when considering that the video amplifier might limit the output to 5 volts! Note, though, that the application of the calibration curve is a theoretical procedure where no electronic or other limitations exist. We trust that if there had been no signal limitations in the camera, and if it had been calibrated far beyond 5 volts, the resulting curve would have been very much the same as our real curve extrapolated beyond 4.1 volts, provided the calibration algorithm is based on radiation physics, like the FLIR Systems algorithm. Of course there must be a limit to such extrapolations.

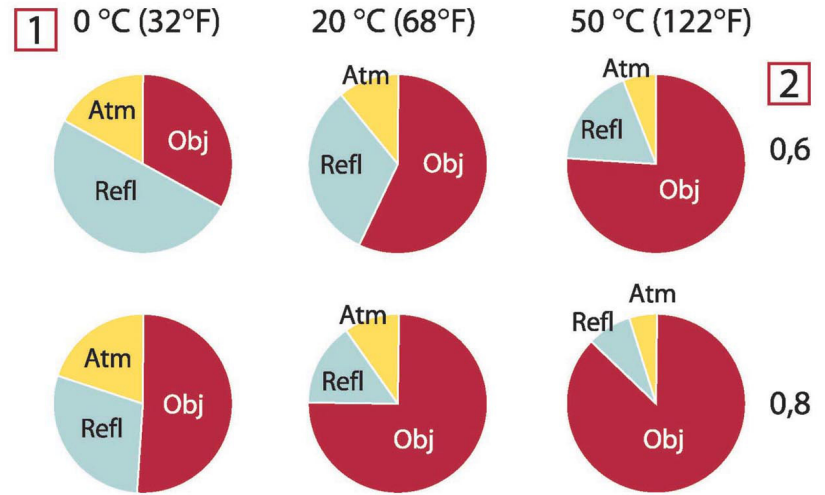

Figure 35.2 Relative magnitudes of radiation sources under varying measurement conditions (SW camera). 1: Object temperature; 2: Emittance; Obj: Object radiation; Refl: Reflected radiation; Atm: atmosphere radiation. Fixed parameters: $\tau = 0.88$; $T_{refl} = 20^{\circ}\text{C}$ (+68°F); $T_{atm} = 20^{\circ}\text{C}$ (+68°F).

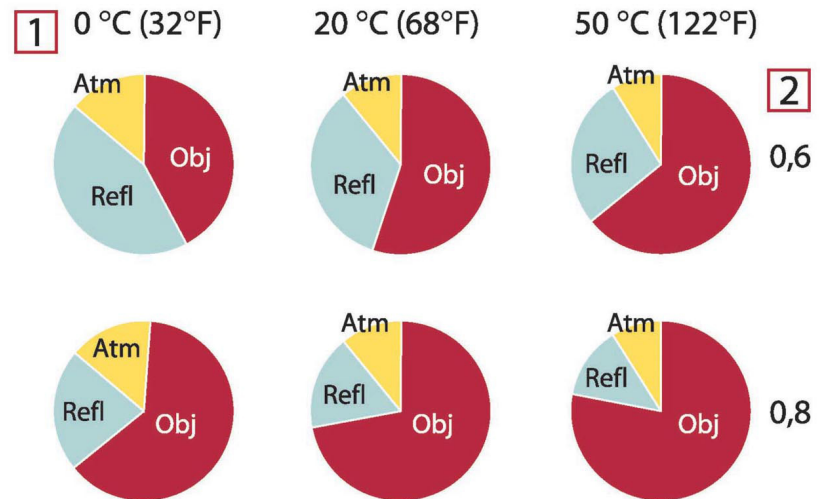

Figure 35.3 Relative magnitudes of radiation sources under varying measurement conditions (LW camera). 1: Object temperature; 2: Emittance; Obj: Object radiation; Refl: Reflected radiation; Atm: atmosphere radiation. Fixed parameters: $\tau = 0.88$; $T_{refl} = 20^{\circ}\text{C}$ (+68°F); $T_{atm} = 20^{\circ}\text{C}$ (+68°F).

This section presents a compilation of emissivity data from the infrared literature and measurements made by FLIR Systems.

36.1 References

1. Mikaél A. Bramson: *Infrared Radiation, A Handbook for Applications*, Plenum press, N. Y.
2. William L. Wolfe, George J. Zissis: *The Infrared Handbook*, Office of Naval Research, Department of Navy, Washington, D.C.
3. Madding, R. P.: *Thermographic Instruments and systems*. Madison, Wisconsin: University of Wisconsin – Extension, Department of Engineering and Applied Science.
4. William L. Wolfe: *Handbook of Military Infrared Technology*, Office of Naval Research, Department of Navy, Washington, D.C.
5. Jones, Smith, Probert: *External thermography of buildings...*, Proc. of the Society of Photo-Optical Instrumentation Engineers, vol.110, Industrial and Civil Applications of Infrared Technology, June 1977 London.
6. Paljak, Pettersson: *Thermography of Buildings*, Swedish Building Research Institute, Stockholm 1972.
7. Vlcek, J.: *Determination of emissivity with imaging radiometers and some emissivities at $\lambda = 5 \mu\text{m}$* . Photogrammetric Engineering and Remote Sensing.
8. Kern: *Evaluation of infrared emission of clouds and ground as measured by weather satellites*, Defence Documentation Center, AD 617 417.
9. Öhman, Claes: *Emittansmätningar med AGEMA E-Box*. Teknisk rapport, AGEMA 1999. (Emittance measurements using AGEMA E-Box. Technical report, AGEMA 1999.)
10. Matteï, S., Tang-Kwor, E: *Emissivity measurements for Nextel Velvet coating 811-21 between -36°C AND 82°C* .
11. Lohrengel & Todtenhaupt (1996)
12. ITC Technical publication 32.
13. ITC Technical publication 29.
14. Schuster, Norbert and Kolobrodov, Valentin G. *Infrarotthermographie*. Berlin: Wiley-VCH, 2000.

Note The emissivity values in the table below are recorded using a shortwave (SW) camera. The values should be regarded as recommendations only and used with caution.

36.2 Tables

Table 36.1 T: Total spectrum; SW: 2–5 μm ; LW: 8–14 μm , LLW: 6.5–20 μm ; 1: Material; 2: Specification; 3: Temperature in $^{\circ}\text{C}$; 4: Spectrum; 5: Emissivity; 6: Reference

1	2	3	4	5	6
3M type 35	Vinyl electrical tape (several colors)	< 80	LW	≈ 0.96	13
3M type 88	Black vinyl electrical tape	< 105	LW	≈ 0.96	13
3M type 88	Black vinyl electrical tape	< 105	MW	< 0.96	13
3M type Super 33+	Black vinyl electrical tape	< 80	LW	≈ 0.96	13
Aluminum	anodized sheet	100	T	0.55	2

Table 36.1 T: Total spectrum; SW: 2–5 μm ; LW: 8–14 μm , LLW: 6.5–20 μm ; 1: Material; 2: Specification; 3: Temperature in $^{\circ}\text{C}$; 4: Spectrum; 5: Emissivity; 6: Reference (continued)

1	2	3	4	5	6
Aluminum	anodized, black, dull	70	SW	0.67	9
Aluminum	anodized, black, dull	70	LW	0.95	9
Aluminum	anodized, light gray, dull	70	SW	0.61	9
Aluminum	anodized, light gray, dull	70	LW	0.97	9
Aluminum	as received, plate	100	T	0.09	4
Aluminum	as received, sheet	100	T	0.09	2
Aluminum	cast, blast cleaned	70	SW	0.47	9
Aluminum	cast, blast cleaned	70	LW	0.46	9
Aluminum	dipped in HNO_3 , plate	100	T	0.05	4
Aluminum	foil	27	10 μm	0.04	3
Aluminum	foil	27	3 μm	0.09	3
Aluminum	oxidized, strongly	50–500	T	0.2–0.3	1
Aluminum	polished	50–100	T	0.04–0.06	1
Aluminum	polished plate	100	T	0.05	4
Aluminum	polished, sheet	100	T	0.05	2
Aluminum	rough surface	20–50	T	0.06–0.07	1
Aluminum	roughened	27	10 μm	0.18	3
Aluminum	roughened	27	3 μm	0.28	3
Aluminum	sheet, 4 samples differently scratched	70	SW	0.05–0.08	9
Aluminum	sheet, 4 samples differently scratched	70	LW	0.03–0.06	9
Aluminum	vacuum deposited	20	T	0.04	2
Aluminum	weathered, heavily	17	SW	0.83–0.94	5
Aluminum bronze		20	T	0.60	1
Aluminum hydroxide	powder		T	0.28	1
Aluminum oxide	activated, powder		T	0.46	1
Aluminum oxide	pure, powder (alumina)		T	0.16	1
Asbestos	board	20	T	0.96	1
Asbestos	fabric		T	0.78	1
Asbestos	floor tile	35	SW	0.94	7
Asbestos	paper	40–400	T	0.93–0.95	1

Table 36.1 T: Total spectrum; SW: 2–5 μm ; LW: 8–14 μm , LLW: 6.5–20 μm ; 1: Material; 2: Specification; 3: Temperature in $^{\circ}\text{C}$; 4: Spectrum; 5: Emissivity; 6: Reference (continued)

1	2	3	4	5	6
Asbestos	powder		T	0.40–0.60	1
Asbestos	slate	20	T	0.96	1
Asphalt paving		4	LLW	0.967	8
Brass	dull, tarnished	20–350	T	0.22	1
Brass	oxidized	100	T	0.61	2
Brass	oxidized	70	SW	0.04–0.09	9
Brass	oxidized	70	LW	0.03–0.07	9
Brass	oxidized at 600 $^{\circ}\text{C}$	200–600	T	0.59–0.61	1
Brass	polished	200	T	0.03	1
Brass	polished, highly	100	T	0.03	2
Brass	rubbed with 80-grit emery	20	T	0.20	2
Brass	sheet, rolled	20	T	0.06	1
Brass	sheet, worked with emery	20	T	0.2	1
Brick	alumina	17	SW	0.68	5
Brick	common	17	SW	0.86–0.81	5
Brick	Dinas silica, glazed, rough	1100	T	0.85	1
Brick	Dinas silica, refractory	1000	T	0.66	1
Brick	Dinas silica, unglazed, rough	1000	T	0.80	1
Brick	firebrick	17	SW	0.68	5
Brick	fireclay	1000	T	0.75	1
Brick	fireclay	1200	T	0.59	1
Brick	fireclay	20	T	0.85	1
Brick	masonry	35	SW	0.94	7
Brick	masonry, plastered	20	T	0.94	1
Brick	red, common	20	T	0.93	2
Brick	red, rough	20	T	0.88–0.93	1
Brick	refractory, corundum	1000	T	0.46	1
Brick	refractory, magnesite	1000–1300	T	0.38	1
Brick	refractory, strongly radiating	500–1000	T	0.8–0.9	1
Brick	refractory, weakly radiating	500–1000	T	0.65–0.75	1
Brick	silica, 95% SiO_2	1230	T	0.66	1
Brick	sillimanite, 33% SiO_2 , 64% Al_2O_3	1500	T	0.29	1

Table 36.1 T: Total spectrum; SW: 2–5 μm ; LW: 8–14 μm , LLW: 6.5–20 μm ; 1: Material; 2: Specification; 3: Temperature in $^{\circ}\text{C}$; 4: Spectrum; 5: Emissivity; 6: Reference (continued)

1	2	3	4	5	6
Brick	waterproof	17	SW	0.87	5
Bronze	phosphor bronze	70	SW	0.08	9
Bronze	phosphor bronze	70	LW	0.06	9
Bronze	polished	50	T	0.1	1
Bronze	porous, rough	50–150	T	0.55	1
Bronze	powder		T	0.76–0.80	1
Carbon	candle soot	20	T	0.95	2
Carbon	charcoal powder		T	0.96	1
Carbon	graphite powder		T	0.97	1
Carbon	graphite, filed surface	20	T	0.98	2
Carbon	lampblack	20–400	T	0.95–0.97	1
Chipboard	untreated	20	SW	0.90	6
Chromium	polished	50	T	0.10	1
Chromium	polished	500–1000	T	0.28–0.38	1
Clay	fired	70	T	0.91	1
Cloth	black	20	T	0.98	1
Concrete		20	T	0.92	2
Concrete	dry	36	SW	0.95	7
Concrete	rough	17	SW	0.97	5
Concrete	walkway	5	LLW	0.974	8
Copper	commercial, burnished	20	T	0.07	1
Copper	electrolytic, carefully polished	80	T	0.018	1
Copper	electrolytic, polished	–34	T	0.006	4
Copper	molten	1100–1300	T	0.13–0.15	1
Copper	oxidized	50	T	0.6–0.7	1
Copper	oxidized to blackness		T	0.88	1
Copper	oxidized, black	27	T	0.78	4
Copper	oxidized, heavily	20	T	0.78	2
Copper	polished	50–100	T	0.02	1
Copper	polished	100	T	0.03	2
Copper	polished, commercial	27	T	0.03	4
Copper	polished, mechanical	22	T	0.015	4
Copper	pure, carefully prepared surface	22	T	0.008	4
Copper	scraped	27	T	0.07	4

Table 36.1 T: Total spectrum; SW: 2–5 μm ; LW: 8–14 μm , LLW: 6.5–20 μm ; 1: Material; 2: Specification; 3: Temperature in $^{\circ}\text{C}$; 4: Spectrum; 5: Emissivity; 6: Reference (continued)

1	2	3	4	5	6
Copper dioxide	powder		T	0.84	1
Copper oxide	red, powder		T	0.70	1
Ebonite			T	0.89	1
Emery	coarse	80	T	0.85	1
Enamel		20	T	0.9	1
Enamel	lacquer	20	T	0.85–0.95	1
Fiber board	hard, untreated	20	SW	0.85	6
Fiber board	masonite	70	SW	0.75	9
Fiber board	masonite	70	LW	0.88	9
Fiber board	particle board	70	SW	0.77	9
Fiber board	particle board	70	LW	0.89	9
Fiber board	porous, untreated	20	SW	0.85	6
Glass pane (float glass)	non-coated	20	LW	0.97	14
Gold	polished	130	T	0.018	1
Gold	polished, carefully	200–600	T	0.02–0.03	1
Gold	polished, highly	100	T	0.02	2
Granite	polished	20	LLW	0.849	8
Granite	rough	21	LLW	0.879	8
Granite	rough, 4 different samples	70	SW	0.95–0.97	9
Granite	rough, 4 different samples	70	LW	0.77–0.87	9
Gypsum		20	T	0.8–0.9	1
Ice: See Water					
Iron and steel	cold rolled	70	SW	0.20	9
Iron and steel	cold rolled	70	LW	0.09	9
Iron and steel	covered with red rust	20	T	0.61–0.85	1
Iron and steel	electrolytic	100	T	0.05	4
Iron and steel	electrolytic	22	T	0.05	4
Iron and steel	electrolytic	260	T	0.07	4
Iron and steel	electrolytic, carefully polished	175–225	T	0.05–0.06	1
Iron and steel	freshly worked with emery	20	T	0.24	1
Iron and steel	ground sheet	950–1100	T	0.55–0.61	1
Iron and steel	heavily rusted sheet	20	T	0.69	2
Iron and steel	hot rolled	130	T	0.60	1
Iron and steel	hot rolled	20	T	0.77	1
Iron and steel	oxidized	100	T	0.74	4

Table 36.1 T: Total spectrum; SW: 2–5 μm ; LW: 8–14 μm , LLW: 6.5–20 μm ; 1: Material; 2: Specification; 3: Temperature in $^{\circ}\text{C}$; 4: Spectrum; 5: Emissivity; 6: Reference (continued)

1	2	3	4	5	6
Iron and steel	oxidized	100	T	0.74	1
Iron and steel	oxidized	1227	T	0.89	4
Iron and steel	oxidized	125–525	T	0.78–0.82	1
Iron and steel	oxidized	200	T	0.79	2
Iron and steel	oxidized	200–600	T	0.80	1
Iron and steel	oxidized strongly	50	T	0.88	1
Iron and steel	oxidized strongly	500	T	0.98	1
Iron and steel	polished	100	T	0.07	2
Iron and steel	polished	400–1000	T	0.14–0.38	1
Iron and steel	polished sheet	750–1050	T	0.52–0.56	1
Iron and steel	rolled sheet	50	T	0.56	1
Iron and steel	rolled, freshly	20	T	0.24	1
Iron and steel	rough, plane surface	50	T	0.95–0.98	1
Iron and steel	rusted red, sheet	22	T	0.69	4
Iron and steel	rusted, heavily	17	SW	0.96	5
Iron and steel	rusty, red	20	T	0.69	1
Iron and steel	shiny oxide layer, sheet,	20	T	0.82	1
Iron and steel	shiny, etched	150	T	0.16	1
Iron and steel	wrought, carefully polished	40–250	T	0.28	1
Iron galvanized	heavily oxidized	70	SW	0.64	9
Iron galvanized	heavily oxidized	70	LW	0.85	9
Iron galvanized	sheet	92	T	0.07	4
Iron galvanized	sheet, burnished	30	T	0.23	1
Iron galvanized	sheet, oxidized	20	T	0.28	1
Iron tinned	sheet	24	T	0.064	4
Iron, cast	casting	50	T	0.81	1
Iron, cast	ingots	1000	T	0.95	1
Iron, cast	liquid	1300	T	0.28	1
Iron, cast	machined	800–1000	T	0.60–0.70	1
Iron, cast	oxidized	100	T	0.64	2
Iron, cast	oxidized	260	T	0.66	4
Iron, cast	oxidized	38	T	0.63	4
Iron, cast	oxidized	538	T	0.76	4
Iron, cast	oxidized at 600 $^{\circ}\text{C}$	200–600	T	0.64–0.78	1
Iron, cast	polished	200	T	0.21	1
Iron, cast	polished	38	T	0.21	4
Iron, cast	polished	40	T	0.21	2

Table 36.1 T: Total spectrum; SW: 2–5 μm ; LW: 8–14 μm , LLW: 6.5–20 μm ; 1: Material; 2: Specification; 3: Temperature in $^{\circ}\text{C}$; 4: Spectrum; 5: Emissivity; 6: Reference (continued)

1	2	3	4	5	6
Iron, cast	unworked	900–1100	T	0.87–0.95	1
Krylon Ultra-flat black 1602	Flat black	Room temperature up to 175	LW	≈ 0.96	12
Krylon Ultra-flat black 1602	Flat black	Room temperature up to 175	MW	≈ 0.97	12
Lacquer	3 colors sprayed on Aluminum	70	SW	0.50–0.53	9
Lacquer	3 colors sprayed on Aluminum	70	LW	0.92–0.94	9
Lacquer	Aluminum on rough surface	20	T	0.4	1
Lacquer	bakelite	80	T	0.83	1
Lacquer	black, dull	40–100	T	0.96–0.98	1
Lacquer	black, matte	100	T	0.97	2
Lacquer	black, shiny, sprayed on iron	20	T	0.87	1
Lacquer	heat-resistant	100	T	0.92	1
Lacquer	white	100	T	0.92	2
Lacquer	white	40–100	T	0.8–0.95	1
Lead	oxidized at 200 $^{\circ}\text{C}$	200	T	0.63	1
Lead	oxidized, gray	20	T	0.28	1
Lead	oxidized, gray	22	T	0.28	4
Lead	shiny	250	T	0.08	1
Lead	unoxidized, polished	100	T	0.05	4
Lead red		100	T	0.93	4
Lead red, powder		100	T	0.93	1
Leather	tanned		T	0.75–0.80	1
Lime			T	0.3–0.4	1
Magnesium		22	T	0.07	4
Magnesium		260	T	0.13	4
Magnesium		538	T	0.18	4
Magnesium	polished	20	T	0.07	2
Magnesium powder			T	0.86	1
Molybdenum		1500–2200	T	0.19–0.26	1
Molybdenum		600–1000	T	0.08–0.13	1
Molybdenum	filament	700–2500	T	0.1–0.3	1
Mortar		17	SW	0.87	5
Mortar	dry	36	SW	0.94	7
Nextel Velvet 811-21 Black	Flat black	–60–150	LW	> 0.97	10 and 11

Table 36.1 T: Total spectrum; SW: 2–5 μm ; LW: 8–14 μm , LLW: 6.5–20 μm ; 1: Material; 2: Specification; 3: Temperature in $^{\circ}\text{C}$; 4: Spectrum; 5: Emissivity; 6: Reference (continued)

1	2	3	4	5	6
Nichrome	rolled	700	T	0.25	1
Nichrome	sandblasted	700	T	0.70	1
Nichrome	wire, clean	50	T	0.65	1
Nichrome	wire, clean	500–1000	T	0.71–0.79	1
Nichrome	wire, oxidized	50–500	T	0.95–0.98	1
Nickel	bright matte	122	T	0.041	4
Nickel	commercially pure, polished	100	T	0.045	1
Nickel	commercially pure, polished	200–400	T	0.07–0.09	1
Nickel	electrolytic	22	T	0.04	4
Nickel	electrolytic	260	T	0.07	4
Nickel	electrolytic	38	T	0.06	4
Nickel	electrolytic	538	T	0.10	4
Nickel	electroplated on iron, polished	22	T	0.045	4
Nickel	electroplated on iron, unpolished	20	T	0.11–0.40	1
Nickel	electroplated on iron, unpolished	22	T	0.11	4
Nickel	electroplated, polished	20	T	0.05	2
Nickel	oxidized	1227	T	0.85	4
Nickel	oxidized	200	T	0.37	2
Nickel	oxidized	227	T	0.37	4
Nickel	oxidized at 600 $^{\circ}\text{C}$	200–600	T	0.37–0.48	1
Nickel	polished	122	T	0.045	4
Nickel	wire	200–1000	T	0.1–0.2	1
Nickel oxide		1000–1250	T	0.75–0.86	1
Nickel oxide		500–650	T	0.52–0.59	1
Oil, lubricating	0.025 mm film	20	T	0.27	2
Oil, lubricating	0.050 mm film	20	T	0.46	2
Oil, lubricating	0.125 mm film	20	T	0.72	2
Oil, lubricating	film on Ni base: Ni base only	20	T	0.05	2
Oil, lubricating	thick coating	20	T	0.82	2
Paint	8 different colors and qualities	70	SW	0.88–0.96	9
Paint	8 different colors and qualities	70	LW	0.92–0.94	9
Paint	Aluminum, various ages	50–100	T	0.27–0.67	1
Paint	cadmium yellow		T	0.28–0.33	1

Table 36.1 T: Total spectrum; SW: 2–5 µm; LW: 8–14 µm, LLW: 6.5–20 µm; 1: Material; 2: Specification; 3: Temperature in °C; 4: Spectrum; 5: Emissivity; 6: Reference (continued)

1	2	3	4	5	6
Paint	chrome green		T	0.65–0.70	1
Paint	cobalt blue		T	0.7–0.8	1
Paint	oil	17	SW	0.87	5
Paint	oil based, average of 16 colors	100	T	0.94	2
Paint	oil, black flat	20	SW	0.94	6
Paint	oil, black gloss	20	SW	0.92	6
Paint	oil, gray flat	20	SW	0.97	6
Paint	oil, gray gloss	20	SW	0.96	6
Paint	oil, various colors	100	T	0.92–0.96	1
Paint	plastic, black	20	SW	0.95	6
Paint	plastic, white	20	SW	0.84	6
Paper	4 different colors	70	SW	0.68–0.74	9
Paper	4 different colors	70	LW	0.92–0.94	9
Paper	black		T	0.90	1
Paper	black, dull		T	0.94	1
Paper	black, dull	70	SW	0.86	9
Paper	black, dull	70	LW	0.89	9
Paper	blue, dark		T	0.84	1
Paper	coated with black lacquer		T	0.93	1
Paper	green		T	0.85	1
Paper	red		T	0.76	1
Paper	white	20	T	0.7–0.9	1
Paper	white bond	20	T	0.93	2
Paper	white, 3 different glosses	70	SW	0.76–0.78	9
Paper	white, 3 different glosses	70	LW	0.88–0.90	9
Paper	yellow		T	0.72	1
Plaster		17	SW	0.86	5
Plaster	plasterboard, untreated	20	SW	0.90	6
Plaster	rough coat	20	T	0.91	2
Plastic	glass fibre laminate (printed circ. board)	70	SW	0.94	9
Plastic	glass fibre laminate (printed circ. board)	70	LW	0.91	9
Plastic	polyurethane isolation board	70	LW	0.55	9

Table 36.1 T: Total spectrum; SW: 2–5 μm ; LW: 8–14 μm , LLW: 6.5–20 μm ; 1: Material; 2: Specification; 3: Temperature in $^{\circ}\text{C}$; 4: Spectrum; 5: Emissivity; 6: Reference (continued)

1	2	3	4	5	6
Plastic	polyurethane isolation board	70	SW	0.29	9
Plastic	PVC, plastic floor, dull, structured	70	SW	0.94	9
Plastic	PVC, plastic floor, dull, structured	70	LW	0.93	9
Platinum		100	T	0.05	4
Platinum		1000–1500	T	0.14–0.18	1
Platinum		1094	T	0.18	4
Platinum		17	T	0.016	4
Platinum		22	T	0.03	4
Platinum		260	T	0.06	4
Platinum		538	T	0.10	4
Platinum	pure, polished	200–600	T	0.05–0.10	1
Platinum	ribbon	900–1100	T	0.12–0.17	1
Platinum	wire	1400	T	0.18	1
Platinum	wire	500–1000	T	0.10–0.16	1
Platinum	wire	50–200	T	0.06–0.07	1
Porcelain	glazed	20	T	0.92	1
Porcelain	white, shiny		T	0.70–0.75	1
Rubber	hard	20	T	0.95	1
Rubber	soft, gray, rough	20	T	0.95	1
Sand			T	0.60	1
Sand		20	T	0.90	2
Sandstone	polished	19	LLW	0.909	8
Sandstone	rough	19	LLW	0.935	8
Silver	polished	100	T	0.03	2
Silver	pure, polished	200–600	T	0.02–0.03	1
Skin	human	32	T	0.98	2
Slag	boiler	0–100	T	0.97–0.93	1
Slag	boiler	1400–1800	T	0.69–0.67	1
Slag	boiler	200–500	T	0.89–0.78	1
Slag	boiler	600–1200	T	0.76–0.70	1
Snow: See Water					
Soil	dry	20	T	0.92	2
Soil	saturated with water	20	T	0.95	2
Stainless steel	alloy, 8% Ni, 18% Cr	500	T	0.35	1
Stainless steel	rolled	700	T	0.45	1
Stainless steel	sandblasted	700	T	0.70	1
Stainless steel	sheet, polished	70	SW	0.18	9

Table 36.1 T: Total spectrum; SW: 2–5 µm; LW: 8–14 µm, LLW: 6.5–20 µm; 1: Material; 2: Specification; 3: Temperature in °C; 4: Spectrum; 5: Emissivity; 6: Reference (continued)

1	2	3	4	5	6
Stainless steel	sheet, polished	70	LW	0.14	9
Stainless steel	sheet, untreated, somewhat scratched	70	SW	0.30	9
Stainless steel	sheet, untreated, somewhat scratched	70	LW	0.28	9
Stainless steel	type 18-8, buffed	20	T	0.16	2
Stainless steel	type 18-8, oxidized at 800°C	60	T	0.85	2
Stucco	rough, lime	10–90	T	0.91	1
Styrofoam	insulation	37	SW	0.60	7
Tar			T	0.79–0.84	1
Tar	paper	20	T	0.91–0.93	1
Tile	glazed	17	SW	0.94	5
Tin	burnished	20–50	T	0.04–0.06	1
Tin	tin-plated sheet iron	100	T	0.07	2
Titanium	oxidized at 540°C	1000	T	0.60	1
Titanium	oxidized at 540°C	200	T	0.40	1
Titanium	oxidized at 540°C	500	T	0.50	1
Titanium	polished	1000	T	0.36	1
Titanium	polished	200	T	0.15	1
Titanium	polished	500	T	0.20	1
Tungsten		1500–2200	T	0.24–0.31	1
Tungsten		200	T	0.05	1
Tungsten		600–1000	T	0.1–0.16	1
Tungsten	filament	3300	T	0.39	1
Varnish	flat	20	SW	0.93	6
Varnish	on oak parquet floor	70	SW	0.90	9
Varnish	on oak parquet floor	70	LW	0.90–0.93	9
Wallpaper	slight pattern, light gray	20	SW	0.85	6
Wallpaper	slight pattern, red	20	SW	0.90	6
Water	distilled	20	T	0.96	2
Water	frost crystals	–10	T	0.98	2
Water	ice, covered with heavy frost	0	T	0.98	1
Water	ice, smooth	0	T	0.97	1
Water	ice, smooth	–10	T	0.96	2
Water	layer >0.1 mm thick	0–100	T	0.95–0.98	1

Table 36.1 T: Total spectrum; SW: 2–5 μm ; LW: 8–14 μm , LLW: 6.5–20 μm ; 1: Material; 2: Specification; 3: Temperature in $^{\circ}\text{C}$; 4: Spectrum; 5: Emissivity; 6: Reference (continued)

1	2	3	4	5	6
Water	snow		T	0.8	1
Water	snow	-10	T	0.85	2
Wood		17	SW	0.98	5
Wood		19	LLW	0.962	8
Wood	ground		T	0.5–0.7	1
Wood	pine, 4 different samples	70	SW	0.67–0.75	9
Wood	pine, 4 different samples	70	LW	0.81–0.89	9
Wood	planed	20	T	0.8–0.9	1
Wood	planed oak	20	T	0.90	2
Wood	planed oak	70	SW	0.77	9
Wood	planed oak	70	LW	0.88	9
Wood	plywood, smooth, dry	36	SW	0.82	7
Wood	plywood, untreated	20	SW	0.83	6
Wood	white, damp	20	T	0.7–0.8	1
Zinc	oxidized at 400 $^{\circ}\text{C}$	400	T	0.11	1
Zinc	oxidized surface	1000–1200	T	0.50–0.60	1
Zinc	polished	200–300	T	0.04–0.05	1
Zinc	sheet	50	T	0.20	1

A note on the technical production of this publication

This publication was produced using XML — the eXtensible Markup Language. For more information about XML, please visit <http://www.w3.org/XML/>

A note on the typeface used in this publication

This publication was typeset using Linotype Helvetica™ World. Helvetica™ was designed by Max Miedinger (1910–1980)

LOEF (List Of Effective Files)

T501012.xml; en-US; AH; 45951; 2017-10-23
T505777.xml; en-US; 17617; 2014-09-24
T505778.xml; en-US; 39860; 2017-01-31
T505776.xml; en-US; 39513; 2017-01-18
T505013.xml; en-US; 39689; 2017-01-25
T505251.xml; en-US; 39513; 2017-01-18
T505252.xml; en-US; 39860; 2017-01-31
T505236.xml; en-US; 39860; 2017-01-31
T505307.xml; en-US; 39860; 2017-01-31
T505237.xml; en-US; 39860; 2017-01-31
T505401.xml; en-US; 39860; 2017-01-31
T505249.xml; en-US; 39860; 2017-01-31
T505402.xml; en-US; 39860; 2017-01-31
T505238.xml; en-US; 39860; 2017-01-31
T505240.xml; en-US; 39860; 2017-01-31
T505241.xml; en-US; 39860; 2017-01-31
T505310.xml; en-US; 39513; 2017-01-18
T505403.xml; en-US; 39513; 2017-01-18
T505404.xml; en-US; 39860; 2017-01-31
T505243.xml; en-US; 39859; 2017-01-31
T505470.xml; en-US; 39513; 2017-01-18
T505485.xml; en-US; 39513; 2017-01-18
T505427.xml; en-US; 39860; 2017-01-31
T505432.xml; en-US; 39513; 2017-01-18
T505007.xml; en-US; 42810; 2017-05-23
T506125.xml; en-US; 40753; 2017-03-02
T506051.xml; en-US; 40460; 2017-02-20
T505000.xml; en-US; 39687; 2017-01-25
T505005.xml; en-US; 43349; 2017-06-14
T505001.xml; en-US; 41563; 2017-03-23
T505006.xml; en-US; 41563; 2017-03-23
T505002.xml; en-US; 39512; 2017-01-18



Website

<http://www.flir.com>

Customer support

<http://support.flir.com>

Copyright

© 2017, FLIR Systems, Inc. All rights reserved worldwide.

Disclaimer

Specifications subject to change without further notice. Models and accessories subject to regional market considerations. License procedures may apply. Products described herein may be subject to US Export Regulations. Please refer to exportquestions@flir.com with any questions.

Publ. No.: T559157
Release: AH
Commit: 45951
Head: 45951
Language: en-US
Modified: 2017-10-23
Formatted: 2017-10-23