

**User's
Manual**

DL950 ScopeCorder Getting Started Guide



Product Registration

Thank you for purchasing YOKOGAWA products.

YOKOGAWA provides registered users with a variety of information and services. Please allow us to serve you best by completing the product registration form accessible from our website.

<https://tmi.yokogawa.com/>

Thank you for purchasing the DL950 ScopeCorder.

The DL950 is a plug-in modular measuring instrument that allows monitoring of changes in electric signals in the form of waveforms.

Up to eight plug-in modules can be installed according to the electric signals you want to measure. This allows simultaneous measurement of various types of data. In addition, you can use the measured data to perform various computations and analysis and save it to storage devices.

This getting started guide primarily explains the handling precautions and basic operations of this instrument. To ensure correct use, please read this manual thoroughly before operation. Keep this manual in a safe place for quick reference in the event that a question arises. The manuals for this instrument are listed on the page iii. Please read all manuals.

Contact information of Yokogawa offices worldwide is provided on the following sheet.

Document No.	Description
PIM 113-01Z2	List of worldwide contacts

Notes

- The contents of this manual are subject to change without prior notice as a result of continuing improvements to the instrument's performance and functionality. The figures given in this manual may differ from those that actually appear on your screen.
- Every effort has been made in the preparation of this manual to ensure the accuracy of its contents. However, should you have any questions or find any errors, please contact your nearest YOKOGAWA dealer.
- Copying or reproducing all or any part of the contents of this manual without the permission of YOKOGAWA is strictly prohibited.
- The TCP/IP software of this product and the documents concerning it have been developed/created by YOKOGAWA based on the BSD Networking Software, Release 1 that has been licensed from the Regents of the University of California.

Trademarks

- Microsoft, Internet Explorer, Windows, Windows 8.1, and Windows 10 are registered trademarks or trademarks of Microsoft Corporation in the United States and/or other countries.
- Adobe and Acrobat are either registered trademarks or trademarks of Adobe Systems Incorporated.
- PIEZOTRON is a registered Trademark of Kistler Instrumente AG.
- ICP is a registered trademark of PCB Piezotronics Incorporated.
- Isotron is a registered trademark of Meggitt Group, PLC.
- VJE is a registered trademark of Yahoo Japan Corporation.
- MATLAB is a registered trademark of The MathWorks, Inc. in the United States.
- GIGAZOOM ENGINE is a registered trademark of YOKOGAWA Electric Corporation.
- In this manual, the TM and ® symbols do not accompany their respective registered trademark or trademark names.
- Other company and product names are trademarks or registered trademarks of their respective holders.

Revisions

- 1st Edition: February 2021
- 2nd Edition: April 2021

Manuals

The following manuals, including this one, are provided as manuals for this instrument. Please read all manuals.

Manual Title	Manual No.	Description
DL950 ScopeCorder Features Guide	IM DL950-01EN	The supplied CD contains the PDF file of this manual. This manual explains all the instrument's features other than the communication interface features.
DL950 ScopeCorder User's Manual	IM DL950-02EN	The supplied CD contains the PDF file of this manual. The manual explains how to operate this instrument.
DL950 ScopeCorder Getting Started Guide	IM DL950-03EN	This document. Provided as a printed manual. This guide explains the handling precautions, common operations, troubleshooting measures, and specifications of this instrument.
DL950 ScopeCorder Communication Interface User's Manual	IM DL950-17EN	The supplied CD contains the PDF file of this manual. Explains the functions of the this instrument's communication interface, how to configure it, and the commands used to control this instrument from a PC through the interface.
Precautions Concerning the Modules	IM 701250-04	The manual explains the precautions concerning the modules. This manual is included if you ordered modules.
DL950 ScopeCorder	IM DL950-92Z1	Document for China

The "EN", "E", and "Z1" in the manual numbers are the language codes.

Refer to the "Optional Accessories (Sold Separately)" about the accessory's manual number.

Manuals in the CD

The included CD (manual CD) contains the following English and Japanese manuals.

File Name	Manual No.	Description
Features Guide & Users Manual.pdf	IM DL950-01EN IM DL950-02EN	Features Guide and User's Manual
Communication Interface.pdf	IM DL950-17EN	Communication Interface User's Manual

Online Help

The content similar to the Features Guide, IM DL950-01EN, is included in this instrument as a help file (some the content may be omitted). For instructions on how to use the help file, see section 4.11.

Checking the Contents of the Package

Unpack the box, and check the following before operating the instrument. If the wrong items have been delivered, if items are missing, or if there is a problem with the appearance of the items, contact your nearest YOKOGAWA dealer.

DL950

Check that the product that you received is what you ordered by referring to the model name and suffix code given on the name plate on the left side panel.

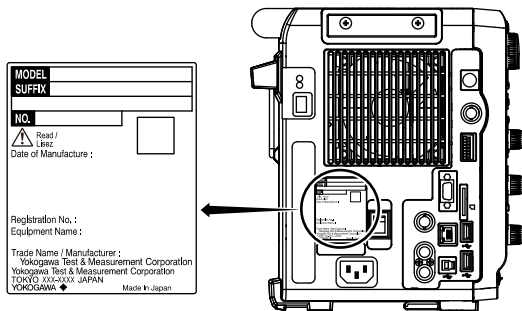

MODEL	Suffix Code ¹	Specifications
DL950		Main unit, 8-slot, 1 G Points memory
Power cord ²	-D	UL/CSA Standard and PSE compliant, Rated voltage: 125 V
	-F	VDE/Korean standard, Rated voltage: 250 V
	-R	Australian standard, Rated voltage: 250 V
	-Q	British standard, Rated voltage: 250 V
	-H	Chinese standard, Rated voltage: 250 V
	-N	Brazilian standard, Rated voltage: 250 V
	-T	Taiwanese standard, Rated voltage: 125 V
	-B	Indian standard, Rated voltage: 250 V
	-U	IEC Plug Type B, Rated voltage: 250 V
	-Y	No power cord included. ³
Language	-HJ	Japanese (menu, panel)
	-HE	English (menu, panel)
	-HC	Chinese (menu, panel)
	-HK	Korean (menu, panel)
	-HG	German (menu, panel)
	-HF	French (menu, panel)
	-HL	Italian (menu, panel)
	-HS	Spanish (menu, panel)
-HR	Russian (menu, panel)	
Options	/M1	Memory expansion to 4 G Points ⁴
	/M2	Memory expansion to 8 G Points ⁴
	/ST1	Internal storage (512 GB)
	/C35	IRIG and GPS interface
	/C40	IEEE 1588 Master function
	/C50	Multi-unit synchronization interface
	/C60	10 Gbps Ethernet interface
	/G02	User-defined math function
	/G03	Real time math function ⁵
	/G05	Power math function (including Real time math function) ⁵
	/P4	Four probe power outputs ⁶
/P8	Eight probe power outputs ⁶	
/VCE	Vehicle edition	

- 1 For products whose suffix code contains "Z," an exclusive manual may be included. Please read it along with the standard manual.
- 2 Make sure that the attached power cord meets the designated standards of the country and area that you are using it in.
- 3 Prepare a power cord that complies with the standard specified by the country or region that the instrument will be used in.
- 4 The /M1 and /M2 options cannot be installed on the same instrument.
- 5 The /G03 and /G05 options cannot be installed on the same instrument.
- 6 The /P4 and /P8 options cannot be installed on the same instrument.

No. (Instrument number)

When contacting the dealer from which you purchased the instrument, please give them the instrument number.

Standard Accessories

The standard accessories below are supplied with the instrument. Check that all contents are present and undamaged.

Item	Model or Part No.	Quantity	Specifications and Notes
Power cord ¹	A1006WD	1	UL/CSA standard and PSE compliant
	A1009WD		VDE/Korean standard
	A1024WD		Australian standard
	A1054WD		British standard
	A1064WD		Chinese standard
	A1103WD		Brazilian standard
	A1100WD		Taiwanese standard
	A1101WD		Indian standard
	A1102WD		IEC Plug Type B
Front panel protection cover	B8217CB	1	—
Soft case	B8059GG	1	—
Panel sheet	See the figure on the next page.	1	Japanese, Chinese, Korean, German, French, Italian, Spanish, or Russian
Cover panel	B8073CY	8	—
Rubber stoppers ²	B9989EX	1 set	4 stoppers in a set (2 of which are spares)
Rubber stoppers ²	B8080FR	4	—
Manuals			
Printed manuals	IM DL950-03EN	1	Getting Started Guide (this guide)
	IM 701250-04E	1	Module Handling Precautions (This manual is included if you ordered modules.)
	IM DL950-92Z1	1	Document for China
	PIM 113-01Z2	1	List of worldwide contacts
Manual CD	A1034US	1	Contains pdf data of the user's manuals. (For the types of manuals that CD contains, see the next page.)

Standard accessories are not covered by warranty.

Checking the Contents of the Package

Power cord (one cord that matches the suffix code is included) ¹

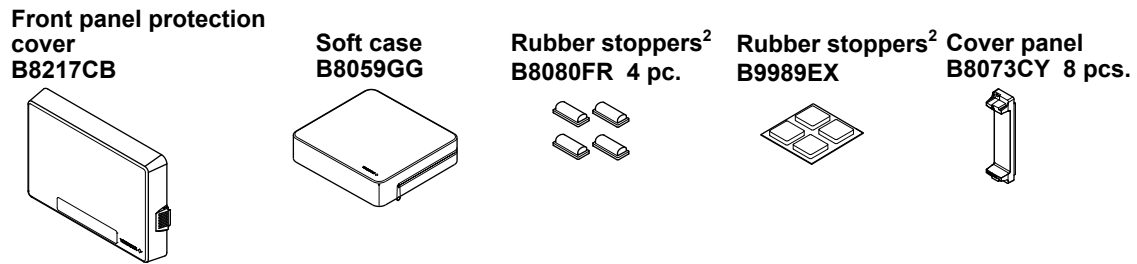
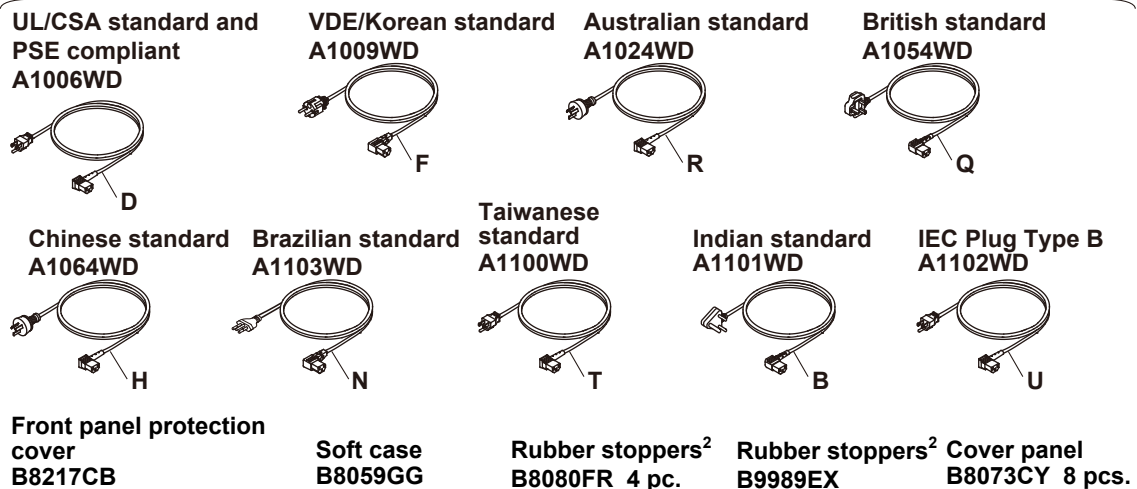

Panel sheet

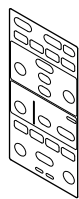

One of the following:

- B8217KD (Japanese -HJ)
- B8217KE (Chinese -HC)
- B8217KF (Korean -HK)
- B8217KG (German -HG)
- B8217KH (French -HF)
- B8217KJ (Italian -HL)
- B8217KK (Spanish -HS)
- B8217KL (Russian -HR)

Manuals

• Printed manuals

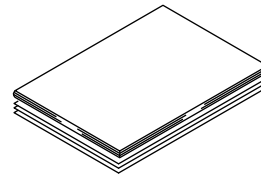

• Manual CD

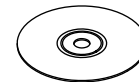

- 1 Make sure that the attached power cord meets the designated standards of the country and area that you are using it in. If the suffix code is -Y, a power cord is not included.
- 2 For instructions on how to attach the rubber stoppers, see section 3.2.

Manual CD

The English folder in the manual CD contains the PDF files shown below. The CD also contains Japanese manuals.

File Name	Manual Title	Manual No.
Features Guide & Users Manual.pdf	DL950 ScopeCorder Features Guide	IM DL950-01EN
	DL950 ScopeCorder User's Manual	IM DL950-02EN
Communication Interface.pdf	DL950 ScopeCorder Communication Interface User's Manual	IM DL950-17EN

To view the PDF data, you need Adobe Acrobat Reader or a software application that can open PDF data.

WARNING

Never play this manual CD, which contains the user's manuals, in an audio CD player. Doing so may cause loss of hearing or speaker damage due to the large sounds that may be produced.

French

AVERTISSEMENT

Ce CD contient les manuels d'utilisation. Ne jamais insérer ce CD dans un lecteur de CD audio. Cela pourrait entraîner une perte d'audition ou l'endommagement des enceintes en raison du volume potentiellement élevé des sons produits.

Input Modules (Sold Separately)

To make sure that an input module is the module that you ordered, check the module name written on it.

Model	Name	Abbreviation
720256	4CH 10MS/s, 16bit Isolation Module	4CH 10M16
701250	High-Speed 10 MS/s, 12-Bit Isolation Module	HS10M12
720250	High-Speed 10 MS/s, 12-Bit Isolation Module	HS10M12
701251	High-Speed High-Resolution 1 MS/s, 16-Bit Isolation Module	HS1M16
701255	High-Speed 10 MS/s, 12-Bit Non-Isolation Module	NONISO_10M12
720268	High-Voltage 1 MS/s 16-Bit Isolation Module (with AAF and RMS)	HV (AAF, RMS)
701261	Universal (Voltage/Temp.) Module	UNIVERSAL
701262	Universal (Voltage/Temp.) Module (with AAF)	UNIVERSAL (AAF)
701265	Temperature, High Precision Voltage Isolation Module	TEMP/HPV
720266	Temperature, High Precision Voltage Isolation Module (low noise)	TEMP/HPV
701270	Strain Module (NDIS)	STRAIN_NDIS
701271	Strain Module (DSUB, Shunt-Cal)	STRAIN_DSUB
701275	Acceleration/Voltage Module (with AAF)	ACCL/VOLT
701281	Frequency Module	FREQ
720281	Frequency Module	FREQ
720212	High-Speed 200MS/s, 14bit Isolation Module	HS200M14
720211	High-Speed 100 MS/s, 12-Bit Isolation Module	HS100M12
720221	16-CH Temperature/Voltage Input Module	16CH TEMP/VOLT
720230	Logic Input Module	LOGIC
720240	CAN Bus Monitor Module*	CAN MONITOR
720241	CAN & LIN Bus Monitor Module*	CAN & LIN
720242	CAN/CAN FD Monitor Module*	CAN/CAN FD
720243	SENT Monitor Module*	SENT
720254	4-CH 1 MS/s, 16-Bit Isolation Module	4CH 1M16

* The CAN bus monitor, CAN&LIN bus monitor, CAN/CAN FD monitor, and SENT monitor modules can be used on models with the /VCE option.

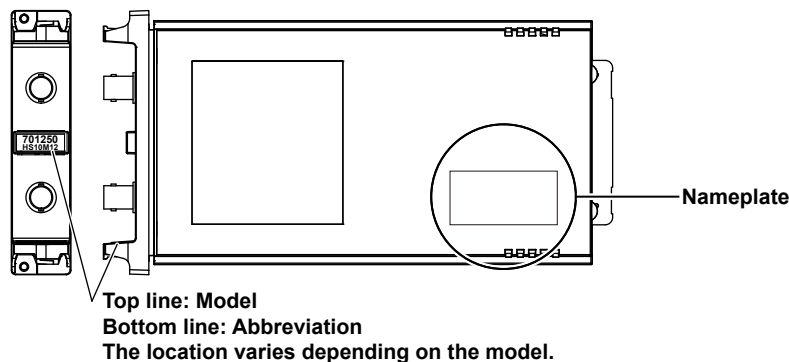

In this manual, input modules are referred to by their model names and abbreviations. For example, the High-Speed 10 MS/s, 12-Bit Isolation Module is referred to as the 701250 (HS10M12). However, if a module has already been referred to previously, it may be referred to only by its model name (for example, 701250).

Note

If you want to use input module 701250 or 701255 shipped between August 2006 and July 2007 with this instrument, the input module firmware must be updated. If error code 916 appears when you turn the instrument on, the firmware of the input module indicated above may need to be updated. Contact your nearest YOKOGAWA dealer, and indicate the module serial number. The module firmware will be updated for a fee.

Optional Accessories (Sold separately)

The optional accessories below are available for purchase separately. For information about ordering accessories, contact your nearest YOKOGAWA dealer.

- Use the following accessories within the ranges indicated in the Notes column of each accessory. When using several accessories together, use them within the specification range of the accessory with the lowest rating.
- If you use accessories other than those below, YOKOGAWA assumes no responsibility or liability for the specifications of this instrument or any damage caused by the use of this instrument.
- Accessories (sold separately) are not covered by this instrument's warranty.

Group 1

Compliance with EN standards is achieved by using the following in combination with the instrument.

Item	Model	Safety Standards	Notes	Manual No.
1:1 BNC safety adapter lead	701901	1000 Vrms CAT II	For the 720256, 701250, 720250, 701251, 720212, 720211, and 720254. Used with the following items (which are sold separately): 701954, 758928, 758922, 758929, or 758921	—
1:1 safety adapter lead	701904	1000 Vrms CAT II 600 Vrms CAT III	For the 720268. Used with the following items (which are sold separately): 701954, 758928, 758922, 758929, or 758921.	—
Measurement lead	758933	1000 Vrms CAT III	1 m in length; for the 720268. Used with the following items (which are sold separately): 701954, 758928, 758922, 758929, or 758921.	—
Alligator clip (dolphin type)	701954	1000 Vrms CAT III	Two pieces in one set (red/black)	—
Safety miniclip (hook type)	758928	1000 Vrms CATIII	Two pieces in one set (red/black)	IM 758928-01EN
Alligator clip adapter	758922	300 Vrms CAT II	Two pieces in one set	—
	758929	1000 Vrms CAT II	Two pieces in one set	—
Fork terminal adapter	758921	1000 Vrms CAT II	Two pieces in one set (red/black). For 4 mm screws.	—
BNC alligator clip*	366926	—	For measuring low voltage of less than or equal to 42 V	—
Banana-alligator clip cable	366961	—	For measuring low voltage of less than or equal to 42 V for the 701261, 701262, 701265, or 720266	—
High-speed logic probe	700986	—	42 V or less, 8 bits, non-isolated, response speed of 1 μ s	—
Isolated logic probe	700987	250 Vrms CAT II	8 bits, each channel isolated, response speed of 20 ms (for AC)	IM 700987-01E
1 m logic probe	702911	—	8 bits, non-isolated	—
3 m logic probe	702912	—	8 bits, non-isolated	—

Checking the Contents of the Package

Item	Model	Safety Standards	Notes	Manual No.
Isolated logic measurement lead	758917	1000 Vrms CAT II	Two leads in one set. Used with the 758922 or 758929 adapter (sold separately).	—
1 m safety BNC cable	701902	1000 Vrms CAT II	—	—
2 m safety BNC cable	701903	1000 Vrms CAT II	—	—
1 m BNC cable	366924	—	42 V or less	—
2 m BNC cable	366925	—	42 V or less	—
Safety BNC-to-banana adapter	758924	500 Vrms CAT II	For the 701250, 720250, 701251, 701255, 720212, 720211	—
Shunt resistor	438920	—	250 Ω \pm 0.1 %	—
	438921	—	100 Ω \pm 0.1 %	—
	438922	—	10 Ω \pm 0.1 %	—
16-CH scanner box	701953-L1	—	For the 720221; cable length: 1 m	—
	701953-L3	—	For the 720221; cable length: 3 m	—
	Accessories: Protection cover 1, Protection cover screw 1, Attaching plate 1, Binding screw 2			—
Connection cable	705926	—	1 m in length; for connecting the 720221 and 701953	—
	705927	—	3 m in length; for connecting the 720221 and 701953	—
Bridgehead	701955	—	NDIS, bridge resistance: 120 Ω	IM 701955-01E
	701956	—	NDIS, bridge resistance: 350 Ω	
	701957	—	DSUB, bridge resistance: 120 Ω , shunt-cal support	IM 701957-01E
	701958	—	DSUB, bridge resistance: 350 Ω , shunt-cal support	
Plug-on clip	701948	1000 Vrms CAT II	For the 700929/701947	IM 701948-01E
Long test clip	701906	1000 Vrms CAT II	Two pieces in one set (red/black)	IM 701906-01E
Soft carrying case	701972	—	—	—
Optical transceiver module	720941	—	1000BASE-SX SFP Module 850 nm	IM 720941-01EN
Optical fiber cord	720942	—	Multi mode optical fiber (LC-LC/3 m)	IM 720942-01EN
The minimum purchase quantity is 1 piece.				

* Use BNC alligator clips (366926) that YOKOGAWA has been shipping since February 4, 1998. BNC alligator clips (366926) shipped before this date cannot be used in combination with this instrument's input modules.

Checking the Contents of the Package

Group 2

The following accessories by themselves comply with EN standards.

Item	Model	Safety Standards	Notes	Manual No.
10:1 safety probe	700929	1000 Vrms CAT II	For isolated BNCs. For the 720256, 701250, 720250, 701251, 701281, 720281, 720212, 720211, 720254	IM 700929-01E
100:1 safety probe	701947	1000 Vrms CAT II	For isolated BNCs. For the 720256, 701250, 720250, 701251, 720212, 720211, 720254	IM 701947-01E
Current probe	701930 ¹	—	150 Arms, DC to 10 MHz	IM 701930-01E
	701931 ¹	—	500 Arms, DC to 2 MHz	IM 701931-01E
	701932 ¹	—	30 Arms, DC to 100 MHz	IM 701932-01E
	701933 ¹	—	30 Arms, DC to 50 MHz	IM 701933-01E
	701917 ¹	—	5 Arms, DC to 50 MHz	IM 701917-01EN
	701918 ¹	—	5 Arms, DC to 120 MHz	IM 701917-01EN
	702915 ¹	—	0.5, 5, 30 Arms, DC to 50 MHz	IM 702915-01EN
	702916 ¹	—	0.5, 5, 30 Arms, DC to 120 MHz	IM 702915-01EN
Clamp-on probe	720930	300 Vrms CAT III	0 to 50 Arms AC (10 mV/A)	IM 720930-01EN
	720931	600 Vrms CAT III	0 to 200 Arms AC (2.5 mV/A)	IM 720930-01EN
10:1 passive probe	701940	—	Non-isolated input on the 701255: 600 V or less, isolated input other than the above: 42 V or less	IM 701940-01E
10:1 safety probe (wide temperature range type)	702902	1000 V (DC+ACpeak) CAT II	For isolated BNCs. For the 720256, 701250, 720250, 701251, 720212, 720211, 720254	IM 702902-01EN
Differential probe	701977 ^{1, 2}	1000 Vrms CAT III 5000 Vrms and 7000 Vpeak (Measurement Category Other (O))	100:1: 700 Vpeak (500 Vrms) 1000:1:7000 Vpeak (5000 Vrms)	IM 701977-01EN
	701978 ^{1, 2}	1000 Vrms CAT III	50:1: ±150 V (DC+ACpeak) 500:1: ±1500 V (DC+ACpeak)	IM 701978-01EN
Probe power supply	701934	—	High current output power supply for external probes (four outputs)	IM 701934-01E
GPS unit	720940	—	Not sold in some countries.	IM 720940-01EN

The minimum purchase quantity is 1 piece.

1 Used by connecting to a probe power terminal (/P4 or /P8 option) or a probe power supply (701934; sold separately).

2 Can only be used on the 701255 Non-Isolation Module.

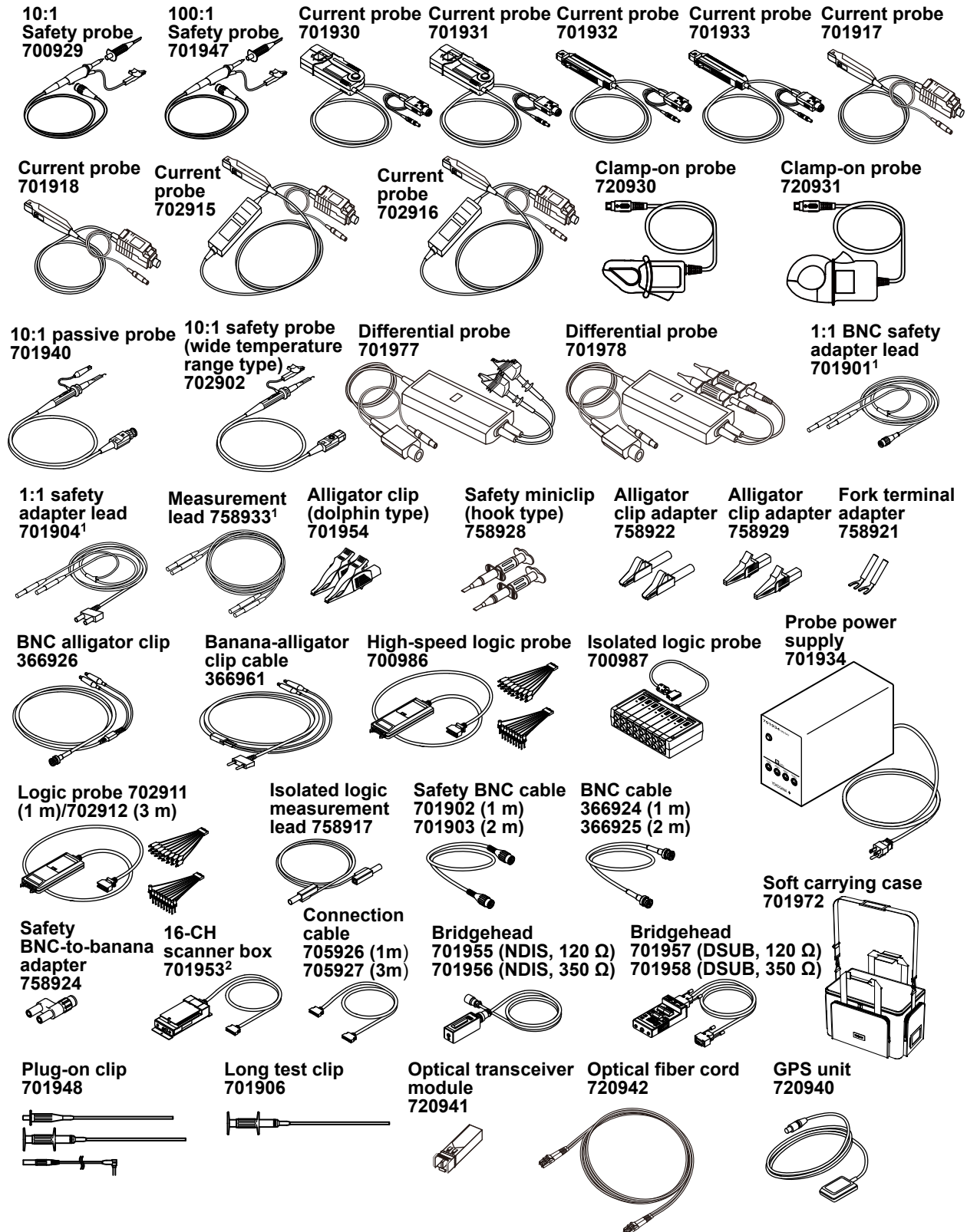

- 1 The 1:1 BNC safety adapter lead (701901), 1:1 safety adapter lead (701904) and the measurement lead (758933) must be used with one of the following accessories (which are sold separately): alligator clip (dolphin type: 701954), safety miniclip (hook type: 758928), alligator adapter (758922 or 758929), or fork terminal adapter (758921).
- 2 The length of the 16-CH scanner box (701953) cable varies depending on the 16-CH scanner box suffix code.

Conventions Used in This Manual

Prefixes k and K

Prefixes k and K used before units are distinguished as follows:

k: Denotes 1000. Example: 100 kS/s (sample rate)

K: Denotes 1024. Example: 720 KB (file size)

Displayed Characters

Bold characters in procedural explanations are used to indicate panel keys and soft keys that are used in the procedure and menu items that appear on the screen.

Notes and Cautions

The notes and cautions in this manual are categorized using the following symbols.



Improper handling or use can lead to injury to the user or damage to the instrument. This symbol appears on the instrument to indicate that the user must refer to the user's manual for special instructions. The same symbol appears in the corresponding place in the user's manual to identify those instructions. In the manual, the symbol is used in conjunction with the word "WARNING" or "CAUTION."

WARNING

Calls attention to actions or conditions that could cause serious or fatal injury to the user, and precautions that can be taken to prevent such occurrences.

CAUTION

Calls attention to actions or conditions that could cause light injury to the user or damage to the instrument or user's data, and precautions that can be taken to prevent such occurrences.

French

AVERTISSEMENT

Attire l'attention sur des gestes ou des conditions susceptibles de provoquer des blessures graves (voire mortelles), et sur les précautions de sécurité pouvant prévenir de tels accidents.

ATTENTION

Attire l'attention sur des gestes ou des conditions susceptibles de provoquer des blessures légères ou d'endommager l'instrument ou les données de l'utilisateur, et sur les précautions de sécurité susceptibles de prévenir de tels accidents.

Note

Calls attention to information that is important for the proper operation of the instrument.

Safety Precautions

This product is designed to be used by a person with specialized knowledge.

This instrument is an IEC safety class I instrument (provided with a terminal for protective earth grounding).

The general safety precautions described herein must be observed during all phases of operation. If the instrument is used in a manner not specified in this manual, the protection provided by the instrument may be impaired. YOKOGAWA assumes no liability for the customer's failure to comply with these requirements.

This manual is part of the product and contains important information. Store this manual in a safe place close to the instrument so that you can refer to it immediately. Keep this manual until you dispose of the instrument.

The following symbols are used on this instrument.



Warning: handle with care. Refer to the user's manual or service manual.

This symbol appears on dangerous locations on the instrument which require special instructions for proper handling or use. The same symbol appears in the corresponding place in the manual to identify those instructions.



Risk of electric shock



Protective earth ground or protective earth ground terminal



Ground or the functional ground terminal (do not use as the protective earth ground terminal)



Alternating current



ON (power)



OFF (power)

French



Avertissement: À manipuler délicatement. Toujours se reporter aux manuels d'utilisation et d'entretien. Ce symbole a été apposé aux endroits dangereux de l'instrument pour lesquels des consignes spéciales d'utilisation ou de manipulation ont été émises. Le même symbole apparaît à l'endroit correspondant du manuel pour identifier les consignes qui s'y rapportent.



Risque de choc électrique



Mise à la terre de protection ou borne de mise à la terre de protection



Borne de terre ou borne de terre fonctionnelle (ne pas utiliser cette borne comme prise de terre.)



Courant alternatif



Marche (alimentation)



Arrêt (alimentation)

Failure to comply with the precautions below could lead to injury or death or damage to the instrument.

WARNING

Use the Instrument Only for Its Intended Purpose

This instrument is a waveform measuring device that monitors and measures electrical signals. Do not use this instrument for anything other than as a waveform measuring device.

Check the Physical Appearance

Do not use the instrument if there is a problem with its physical appearance.

Use the Correct Power supply

First, ensure that the source voltage matches the rated supply voltage of the instrument and that it is within the maximum rated voltage of the power cord you will use. Then connect the power cord.

Use the Correct Power Cord and Plug

To prevent electric shock and fire, be sure use a power cord for this instrument. The main power plug must be plugged into an outlet with a protective earth terminal. Do not invalidate this protection by using an extension cord without protective earth grounding. Further, do not use this power cord with other instruments.

Connect the Protective Ground Terminal

Make sure to connect the protective earth to prevent electric shock before turning on the power. The power cord that you can use for the instrument is a three-prong cord. Connect the power cord to a properly grounded three-prong outlet.

Do Not Impair the Protective Grounding

Never cut off the internal or external protective earth wire or disconnect the wiring of the protective earth terminal. Doing so may result in electric shock or damage to the instrument.

Do Not Use When the Protection Functions Are Defective

Before using this instrument, check that the protection functions, such as the protective grounding and fuse, are working properly. If you suspect a defect, do not use the instrument.

Do Not Operate in an Explosive Atmosphere

Do not operate the instrument in the presence of flammable gases or vapors. Doing so is extremely dangerous.

Do Not Remove the Covers or Disassemble or Alter the Instrument

Only qualified YOKOGAWA personnel may remove the covers and disassemble or alter the instrument. The inside of the instrument is dangerous because parts of it have high voltages.

Ground the Instrument before Making External Connections

Securely connect the protective grounding before connecting to the item under measurement or to an external control circuit. Before touching a circuit, turn off its power and check that it has no voltage.

Precautions to Be Taken When Using the Modules

- Do not apply voltage exceeding the maximum input voltage or maximum rated voltage to ground.
- To avoid electric shock, be sure to ground the instrument.
- To prevent the possibility of electric shock, be sure to fasten the module screws. Otherwise, the electrical and mechanical protection functions will not be activated.
- Avoid continuous connection in an environment where a surge voltage may occur.

Precautions to Be Taken When Using the Probes

- To measure high voltage with the 720256 (4CH 10M16), 701250 (HS10M12), 720250 (HS10M12), 701251 (HS1M16), 720212 (HS200M14), 720211 (HS100M12), or 720254 (4CH 1M16), use the isolated probes (700929, 701947), passive probes 702902, 1:1 safety cables (combination of 701901 and +701954), or differential probes (700924, 700925, 701926).
- Be sure to connect the ground lead of the differential probe (700924, 700925, 701926) to the functional grounding terminal of the instrument before connecting to the measurement target. Not doing so may cause high voltage to appear in the BNC connector of the differential probe.
- The 701977 and 701978 differential probes can only be used on the 701255 (NONISO_10M12) Non-Isolation Module. Using them on an isolation module may cause high voltage to appear in the BNC connector of the differential probe.
- When using the 701255 (NONISO_10M12), be sure to fasten the module screws firmly. The protection functions and non-isolation functions are enabled when the module screws are tightened. It is extremely dangerous if you do not fasten the screws. If you want to measure high voltages at 42 V or higher, be sure to use the 701940 passive probe or the 701977 or 701978 differential probe.

Safety Precautions

- The 701940 passive probe has metal BNC parts. If you want to use it for isolated input (e.g., 701250 (HS10M12), 701251 (HS1M16), 720212 (HS200M14)), use it under 42 V for safety reasons. (Do not connect either the high or low side to an electric potential at 42 V or higher.)
For non-isolated input (e.g., 701255 (NONISO_10M12)), fasten the module screws.
- When measuring high voltages using the 720268 (HV (AFF, RMS)), use a measurement lead 758933 or a 1:1 safety adapter lead 701904 and alligator clip 701954.

Measurement Category

The measurement category of this instrument's signal input terminals varies depending on the modules that are installed. Use the instrument within the scope of the measurement category that corresponds to the module specifications. Do not use the instrument outside the scope of the measurement category that corresponds to the module specifications.

Install or Use the Instrument in Appropriate Locations

- Do not install or use the instrument outdoors or in locations subject to rain or water.
- Install the instrument so that you can immediately remove the power cord if an abnormal or dangerous condition occurs.

CAUTION

Operating Environment Limitations

This product is classified as Class A (for use in industrial environments). Operation of this product in a residential area may cause radio interference, in which case the user will be required to correct the interference.

French

AVERTISSEMENT

Utiliser l'instrument aux seules fins pour lesquelles il est prévu

Cet instrument est un appareil de mesure de forme d'onde pour le contrôle et la mesure des signaux électriques. Ne pas utiliser cet instrument à d'autres fins que celles de mesure de forme d'onde.

Inspecter l'apparence physique

Ne pas utiliser l'instrument si son intégrité physique semble être compromise.

Vérifier l'alimentation

Assurez-vous que la tension d'alimentation correspond à la tension d'alimentation nominale de l'appareil et qu'elle ne dépasse pas la plage de tension maximale du cordon d'alimentation à utiliser.

Utiliser le cordon d'alimentation et la fiche adaptés

Pour éviter tout risque de choc électrique, utiliser exclusivement le cordon d'alimentation prévu pour cet instrument. La fiche doit être branchée sur une prise secteur raccordée à la terre. En cas d'utilisation d'une rallonge, celle-ci doit être impérativement reliée à la terre. Par ailleurs, ne pas utiliser ce cordon d'alimentation avec d'autres instruments.

Brancher la prise de terre

Avant de mettre l'instrument sous tension, penser à brancher la prise de terre pour éviter tout choc électrique. Le cordon d'alimentation que vous utilisez pour l'instrument est un cordon à trois broches. Brancher le cordon d'alimentation sur une prise de courant à trois plots et mise à la terre.

Ne pas entraver la mise à la terre de protection

Ne jamais neutraliser le fil de terre interne ou externe, ni débrancher la borne de mise à la terre. Cela pourrait entraîner un choc électrique ou endommager l'instrument.

Ne pas utiliser lorsque les fonctions de protection sont défectueuses

Avant d'utiliser l'instrument, vérifier que les fonctions de protection, telles que le raccordement à la terre et le fusible, fonctionnent correctement. En cas de dysfonctionnement possible, ne pas utiliser l'instrument.

Ne pas utiliser dans un environnement explosif

Ne pas utiliser l'instrument en présence de gaz et de vapeur inflammables. Cela pourrait être extrêmement dangereux.

Ne pas retirer le capot, ni démonter ou modifier l'instrument

Seul le personnel YOKOGAWA qualifié est habilité à retirer le capot et à démonter ou modifier l'instrument. Certains composants à l'intérieur de l'instrument sont à haute tension et par conséquent, représentent un danger.

Relier l'instrument à la terre avant de le brancher sur des connexions externes

Toujours relier l'instrument à la terre avant de le brancher aux appareils à un circuit de commande externe. Avant de toucher un circuit, mettre l'instrument hors tension et vérifier l'absence de tension.

Précautions à prendre lors de l'utilisation des modules

- Ne pas appliquer une tension dépassant la tension d'entrée maximum ou la tension nominale à la terre maximum.
- Pour éviter tout risque de choc électrique, l'instrument doit impérativement être relié à la terre.
- Pour éviter tout risque de choc électrique, toujours serrer les vis des modules, à défaut de quoi les fonctions de protection électrique et de protection mécanique ne seront pas activées.
- Évitez un branchement continu dans un environnement pouvant être soumis à une surtension.

Précautions à prendre lors de l'utilisation de sondes

- Lors de la mesure de tensions élevées à l'aide du 720256 (4CH 10M16), 701250 (HS10M12), 720250 (HS10M12), 701251 (HS1M16), 720212 (HS200M14), 720211 (HS100M12), ou 720254 (4CH 1M16), utiliser une sonde isolée (700929 ou 701947), un câble de sécurité 1:1 (701901 et +701954 conjointement) ou une sonde différentielle (700924, 700925 ou 701926).
- Veiller à connecter le fil de terre de la sonde différentielle (700924, 700925, 701926) à la borne de mise à la terre fonctionnelle de l'instrument avant de le connecter à la cible de mesure. Sinon, une haute tension pourrait causer dans le connecteur BNC de la sonde différentielle. Le fait de ne pas respecter cette consigne risque d'entraîner l'apparition d'une tension élevée au niveau du connecteur BNC de la sonde différentielle.

Safety Precautions

- Les sondes différentielles 701977 et 701978 ne peuvent être utilisées que sur le module non-isolation 701255 (NONISO_10M12). Leur utilisation sur un module d'isolation pourrait causer l'apparition d'une haute tension dans le connecteur BNC de la sonde différentielle.
- Lors de l'utilisation du 701255 (NONISO_10M12), veiller à bien serrer les vis du module. Les fonctions de protection et les fonctions de non-isolation sont activées lorsque les vis du module sont serrées. Il est extrêmement dangereux si vous ne serrez pas les vis. Si vous souhaitez mesurer des tensions élevées à 42 V ou plus, veillez à utiliser la sonde passive 701940 ou la sonde différentielle 701977 ou 701978 pour cet instrument.
- La sonde passive 701940 comporte des pièces BNC métalliques. Si vous souhaitez l'utiliser pour une entrée isolée (par exemple, 701250 (HS10M12), 701251 (HS1M16), 720212 (HS200M14)), utilisez-la sous 42 V pour la sécurité. (Ne connectez ni le côté haut ni le côté bas à un potentiel électrique de 42 V ou plus.)
Pour une entrée non-isolée (par exemple, 701255 (NONISO_10M12)), serrez les vis du module.
- Lors de la mesure de hautes tensions avec le 720268 (HV (AFF, RMS)), utiliser un cordon de mesure 758933 ou un cordon adaptateur de sécurité 1: 1 701904 et une pince crocodile 701954.

Catégorie de mesure

La catégorie de mesure de ces bornes d'entrée de signal de l'instrument varie en fonction des modules installés. Utilisez l'instrument dans les limites de la catégorie de mesure qui correspondent aux spécifications du module. N'utilisez pas l'instrument en dehors des limites de la catégorie de mesure qui correspondent aux spécifications du module.

Installer et utiliser l'instrument aux emplacements appropriés

- Ne pas installer, ni utiliser l'instrument à l'extérieur ou dans des lieux exposés à la pluie ou à l'eau.
- Installer l'instrument de manière à pouvoir immédiatement le débrancher du secteur en cas de fonctionnement anormal ou dangereux.

ATTENTION

Limitations relatives à l'environnement opérationnel

Ce produit est un produit de classe A (pour environnements industriels). L'utilisation de ce produit dans un zone résidentielle peut entraîner une interférence radio que l'utilisateur sera tenu de rectifier.

Regulations and Sales in Various Countries and Regions

Waste Electrical and Electronic Equipment



Waste Electrical and Electronic Equipment

(This directive is valid only in the EU.)

This product complies with the WEEE directive marking requirement. This marking indicates that you must not discard this electrical/electronic product in domestic household waste.

Product Category

With reference to the equipment types in the WEEE directive, this product is classified as a “Monitoring and control instruments” product.

When disposing of products in the EU, contact your local Yokogawa office in Europe. Do not dispose in domestic household waste.

EU Battery Directive



EU Battery Directive

(This directive is valid only in the EU.)

Batteries are included in this product. This marking indicates they shall be sorted out and collected as ordained in the EU battery directive.

Battery type: Lithium battery

You cannot replace batteries by yourself. When you need to replace batteries, contact your local Yokogawa office in Europe.

Authorized Representative in the EEA

Yokogawa Europe B.V. is the authorized representative of Yokogawa Test & Measurement Corporation for this product in the EEA. To contact Yokogawa Europe B. V., see the separate list of worldwide contacts, PIM 113-01Z2.

關於在台灣銷售

This section is valid only in Taiwan.

關於在台灣所販賣的符合其相關規定的電源線 A1100WD 的限用物質含量信息，請至下麵的網址進行查詢

<https://tmi.yokogawa.com/support/service-warranty-quality/product-compliance/>

Disposal

When disposing of this instrument, follow the laws and ordinances of the country or region where the product will be disposed of.

Contents

Manuals	iii
Checking the Contents of the Package.....	iv
Conventions Used in This Manual	xii
Safety Precautions.....	xiii
Regulations and Sales in Various Countries and Regions.....	xix















Chapter 1 Component Names and Functions

1.1 DL950 Main Unit and Input Modules.....	1-1
1.2 Keys and Knobs.....	1-6
1.3 Screens.....	1-11
1.4 System Configuration.....	1-19

Chapter 2 Main Features

2.1 Operation Mode	2-1
2.2 Application Menu.....	2-1
2.3 Channel Setup	2-2
 2.4 Waveform Acquisition.....	2-4
2.5 Triggering	2-8
2.6 Waveform Display	2-11
2.7 Waveform Computation and Analysis	2-12
2.8 Digital Filter and Real Time Math Function (/G03, /G05 option)	2-14

Chapter 3 Measurement Preparation

3.1 Handling Precautions.....	3-1
3.2 Installing the Instrument.....	3-3
 3.3 Installing Input Modules	3-7
 3.4 Connecting the Power Supply.....	3-14
3.5 Turning the Power Switch On and Off.....	3-16
 3.6 Connecting Probes.....	3-19
 3.7 Correcting the Probe Phase.....	3-33
 3.8 Connecting Measurement Leads	3-36
 3.9 Connecting Thermocouples	3-40
 3.10 Connecting Bridgeheads.....	3-43
 3.11 Connecting a Logic Probe to the Logic Input Module	3-46
 3.12 Connecting an Acceleration Sensor	3-50
 3.13 Connecting Sensors to the Frequency Module	3-53
 3.14 Connecting Wires to the 16-CH Temperature/ Voltage Input Module	3-56
 3.15 Connecting a Cable to the CAN Bus Monitor or CAN/CAN FD Bus Monitor Module...	3-61
 3.16 Connecting a Cable to the CAN & LIN Bus Monitor Module	3-63
3.17 Affixing the Panel Sheet.....	3-65
3.18 Connecting the GPS Unit (/35 option).....	3-66
 3.19 Installing an Optical Transceiver Module and Connecting an Optical Fiber Cord (/C50, /C60 option).....	3-67

Chapter 4 Common Operations

4.1 Key and Jog Dial Operations 4-1

4.2 Touch Panel Operations 4-4

4.3 Entering Values and Strings 4-6

4.4 Using USB Keyboards and Mouse Devices 4-8

4.5 Synchronizing the Clock 4-10

4.6 Initializing Settings 4-12

4.7 Switching the Operation Mode 4-13

4.8 Performing Auto Setup 4-14

4.9 Calibrating the Instrument 4-16

4.10 Starting and Stopping Waveform Acquisition 4-17

4.11 Displaying Help 4-18

Chapter 5 External Signal I/O

▲ 5.1 External Trigger Input (TRIGGER IN) 5-1

▲ 5.2 Trigger Output (TRIGGER OUT) 5-2

▲ 5.3 External Clock Input (EXT CLK IN) 5-4

▲ 5.4 Sample Clock Output (CLKO) 5-5

▲ 5.5 GO/NO-GO Determination Output (GO/NOGO) 5-7

▲ 5.6 External Start/Stop/Event Input (START/EVENT) 5-9

▲ 5.7 Video Signal Output (VIDEO OUT (XGA)) 5-11

▲ 5.8 IRIG Signal Input (IRIG)/(C35 option) 5-13

5.9 GPS Signal Input (GPS)/(C35 option) 5-14

Chapter 6 Troubleshooting, Maintenance, and Inspection

6.1 If a Problem Occurs 6-1

6.2 Messages and Corrective Actions 6-3

6.3 Carrying Out Self-Tests 6-15

6.4 Viewing System Information (Overview) 6-17

6.5 Recommended Part Replacement 6-18

6.6 Disposal 6-18

Chapter 7 Specifications

7.1 Signal Input Section 7-1

7.2 Scope Mode Features 7-1

7.3 Recorder Mode Features 7-5

7.4 Real time math (/G03, /G05) 7-7

7.5 Time Axis 7-12

7.6 Display 7-12

7.7 Saving Data 7-13

7.8 PC Data Streaming 7-13

7.9 Multi-Unit Synchronization (/C50) 7-13

7.10 Storage 7-14

7.11 USB Ports for Peripherals 7-14

7.12 Auxiliary I/O Section 7-15

7.13 Computer Interface 7-17

7.14 General Specifications 7-18

1

2

3

4

5

6

7

App

Index

Contents

7.15	Module Specifications	7-20
	4CH 10MS/s, 16bit Isolation Module (720256)	7-20
	High-Speed 10 MS/s, 12-Bit Isolation Module (701250)	7-22
	High-Speed 10 MS/s, 12-Bit Isolation Module (720250)	7-24
	High-Speed High-Resolution 1 MS/s, 16-Bit Isolation Module (701251)	7-26
	High-Speed 10 MS/s, 12-Bit Non-Isolation Module (701255)	7-28
	High-Voltage 1 MS/s 16-Bit Isolation Module (with AAF and RMS) (720268)	7-29
	Universal (Voltage/Temp.) Module (701261), Universal (Voltage/Temp.) Module (with AAF) (701262)	7-31
	Temperature, High Precision Voltage Isolation Module (701265)	7-33
	Temperature, High Precision Voltage Isolation Module (low noise) (720266)	7-35
	Strain Module (NDIS) (701270)	7-37
	Strain Module (DSUB, Shunt-Cal) (701271)	7-39
	Acceleration/Voltage Module (with AAF) (701275)	7-41
	Frequency Module (701281)	7-43
	Frequency Module (720281)	7-47
	High-Speed 200MS/s, 14bit Isolation Module (720212)	7-51
	High-Speed 100 MS/s, 12-Bit Isolation Module (720211)	7-53
	16-CH Temperature/Voltage Input Module (720221)	7-55
	Logic Input Module (720230)	7-57
	CAN Bus Monitor Module (720240)	7-57
	CAN & LIN Bus Monitor Module (720241)	7-58
	CAN/CAN FD Monitor Module (720242)	7-59
	SENT Monitor Module (720243)	7-60
	4-CH 1 MS/s, 16-Bit Isolation Module (720254)	7-61
7.16	Logic Probe Specifications	7-63
7.17	16-CH Scanner Box Specifications	7-65
7.18	External Dimensions	7-66

Appendix

Appendix 1	Using the Appendix	App-1
Appendix 2	Relationship between the Time Scale, Sample Rate, and Record Length (Scope mode only)	App-7
Appendix 3	Relationship between the Main Channel Sample Rate, Sub Channel Data Update Rate, and Acquisition Memory Writing Rate	App-42
Appendix 4	Record Length and Maximum Number of Channels	App-44
Appendix 5	Maximum Number of History Waveform Acquisitions (Scope mode only)	App-46
Appendix 6	Maximum Sample Rate for SSD Recording	App-48
Appendix 7	Dual Capture (High-Speed Sampling) Acquisition Count (Scope mode only)	App-49
Appendix 8	Acquisition/Record Time and Sample Interval (Recorder mode only)	App-51
Appendix 9	Default Settings	App-58
Appendix 10	USB Keyboard Key Assignments	App-63
Appendix 11	Block Diagram	App-64
Appendix 12	Modules' Maximum Input Voltages	App-68

Index

1.1 DL950 Main Unit and Input Modules

DL950

Top Panel

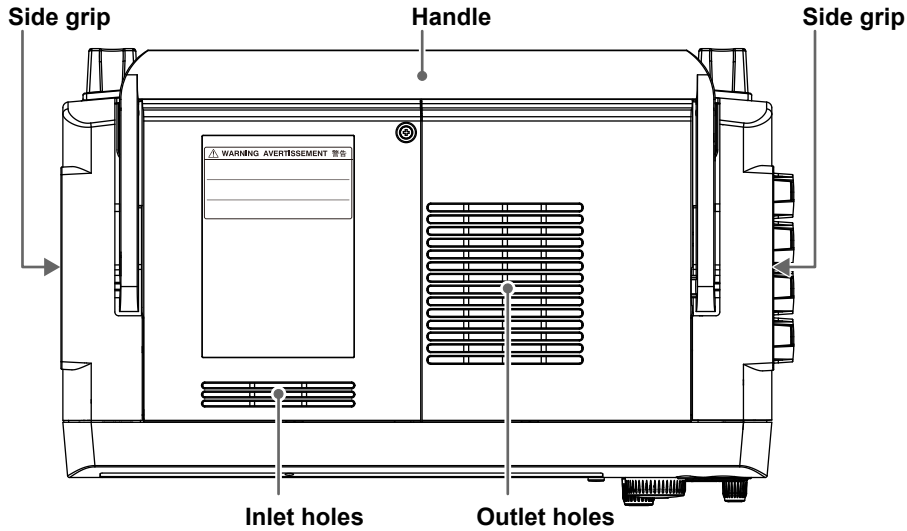

Front Panel

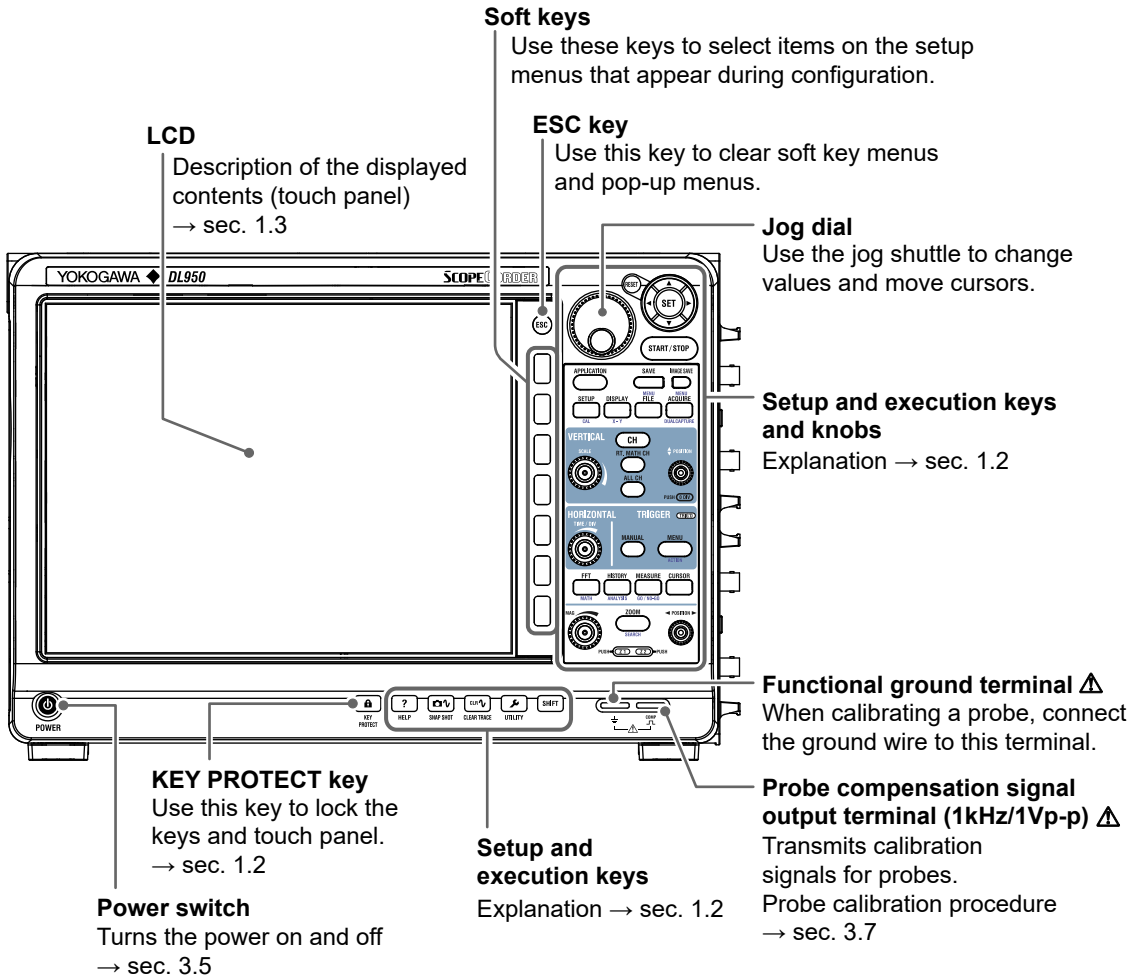

Right Side Panel

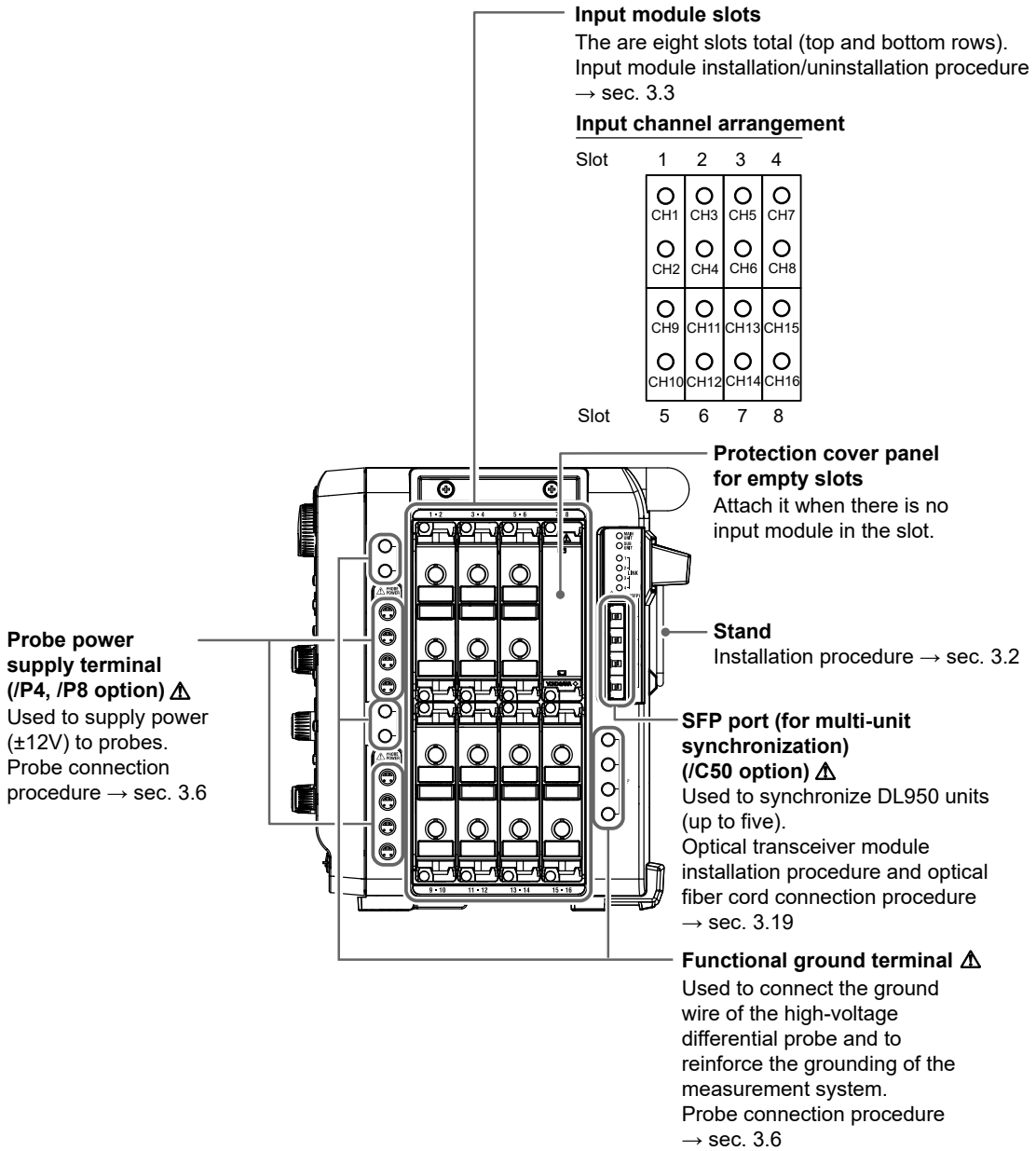

Left Side Panel

GPS input terminal (/C35 option)

Used to receive external GPS signals.
Usage explanation → sec. 3.18

IRIG input terminal (/C35 option) ⚠

Used to receive sync signals (IRIG signals) from an external source.
Usage explanation → sec. 5.8

**SFP+ port ⚠
(10GBASE-R)
(/C60 option)**

Used for 10 Gbps Ethernet communication.
Optical transceiver module installation procedure and optical fiber cord connection procedure → sec. 3.19

Video signal output terminal

Outputs displayed images in XGA format using RGB signals.
Usage explanation → sec. 5.7

Name plate

Main power switch

Turns the power on and off → sec. 3.5

Power inlet ⚠

Power connection → sec. 3.4

External clock input terminal ⚠

Used to receive external clock signals.
Usage explanation → sec. 5.3

Trigger input terminal ⚠

Used to receive external trigger signals.
Usage explanation → sec. 5.1

Trigger output terminal ⚠

Used to output trigger signals.
Usage explanation → sec. 5.2

EVNT
STRT
GND
GO
NOGO
GND
CLKO
GND

Outlet holes

Manual event input terminal ⚠
Used to receive manual event signals. → sec. 5.6

External start/stop input terminal ⚠
Used to start and stop the instrument using external signals. → sec. 5.6

GO/NO-GO output terminal ⚠
Transmits GO/NO-GO determination output signals. → sec. 5.5

Sample clock output terminal ⚠
Used to output clock signal from the instrument. → sec. 5.4

SD memory card slot ⚠

Used to connect a SD memory card.
Usage explanation → User's Manual

**Ethernet port
(1000BASE-T/100BASE-TX/10BASE-T)**

Used to connect to a LAN.
Usage explanation → User's Manual and Communication Interface User's Manual

USB ports for peripherals

Used to connect a USB keyboard, mouse, printer, or storage device.
Usage explanation → sec. 4.4 and User's Manual

USB port for PCs

Used to connect to a PC with a USB port.
Usage explanation → communication interface user's manual

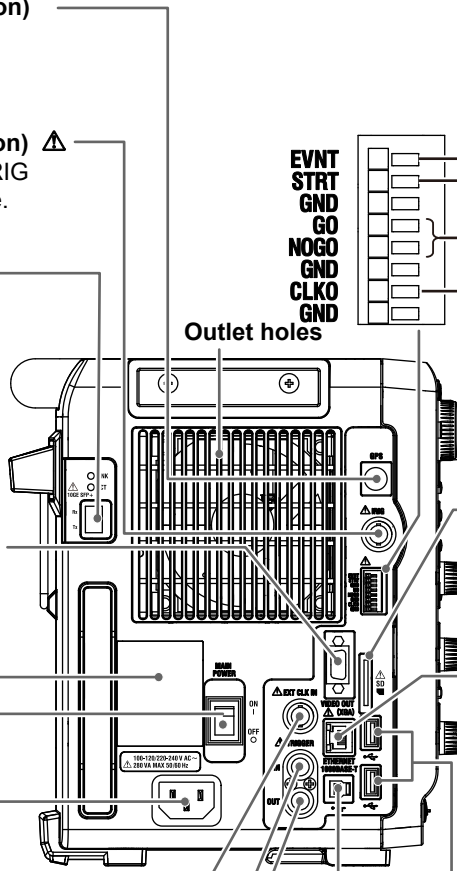

Input Modules

The following input modules are available.

High-Speed 10 MS/s, 12-Bit
Isolation Module
HS10M12 (701250)

High-Speed High-Resolution 1 MS/s,
16-Bit Isolation Module
HS1M16 (701251)

High-Speed 10 MS/s, 12-Bit
Non-Isolation Module
NONISO_10M12 (701255)

Acceleration/Voltage Module
(with AAF)
ACCL/VOLT (701275)

High-Speed 100 MS/s, 12-Bit
Isolation Module
HS100M12 (720211)

Frequency Module
FREQ (701281)

Universal (Voltage/Temp.)
Module
UNIVERSAL (701261)

Universal (Voltage/Temp.)
Module (with AAF)
UNIVERSAL (AAF) (701262)

Temperature, High Precision
Voltage Isolation Module
TEMP/HPV (701265, 720266)

4CH 10MS/s, 16bit
Isolation Module
4CH 10M16 (720256)

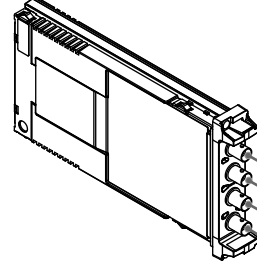

Signal input terminal
(4ch)

High-Speed 10 MS/s, 12-Bit
Isolation Module
HS10M12 (720250)

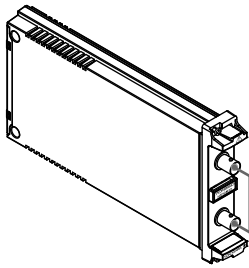

Signal input terminal
(2ch)

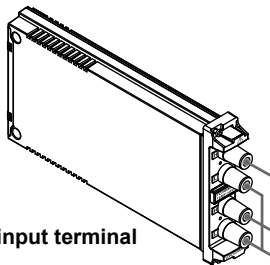

H input terminal
L input terminal
(2ch)

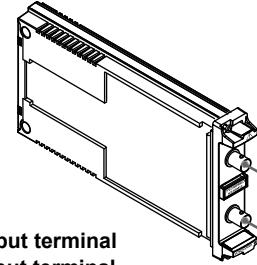

Signal input terminal
(2ch)

High-Voltage 1 MS/s 16-Bit
Isolation Module
(with AAF and RMS)
HV (AAF, RMS) (720268)

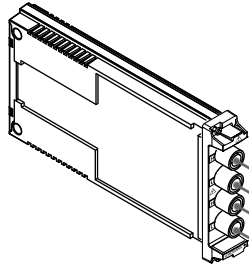

H input terminal
L input terminal
(2ch)

Strain Module
(NDIS)
STRAIN_NDIS (701270)

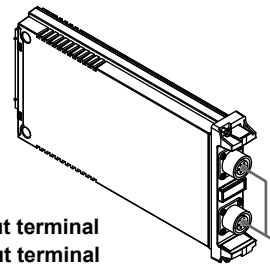

Signal input terminal
(2ch)

Strain Module
(DSUB, shunt-cal support)
STRAIN_DSUB (701271)

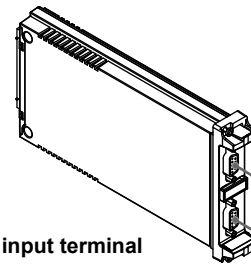

Signal input terminal
(2ch)

Frequency Module
FREQ (720281)

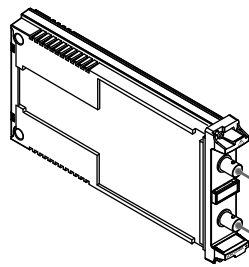

Signal input terminal
(2ch)

16-CH Temperature/Voltage
Input Module
16CH TEMP/VOLT (720221)

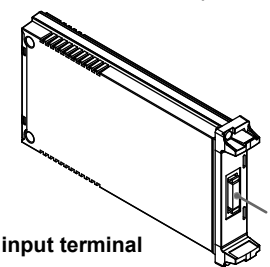

Signal input terminal
(16ch)

High-Speed 200MS/s, 14bit
Isolation Module
HS200M14 (720212)

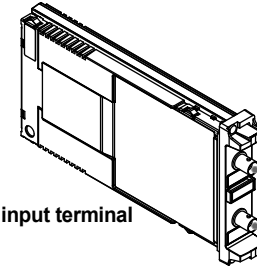

Signal input terminal
(2ch)

**Logic Input Module
LOGIC (720230)**

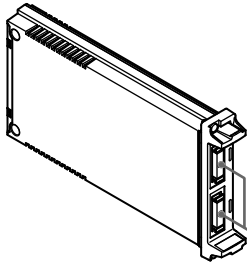

Logic probe terminal

**CAN Bus Monitor Module
CAN MONITOR (720240)**

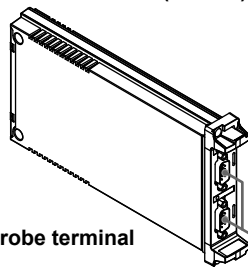

CAN bus signal
input terminal

**CAN & LIN Bus Monitor Module
CAN & LIN (720241)**

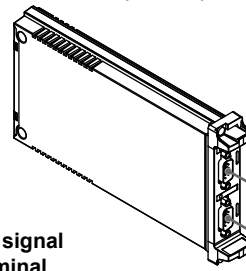

CAN bus signal
input terminal
LIN bus signal
input terminal

**CAN/CAN FD Monitor Module
CAN/CAN FD (720242)**

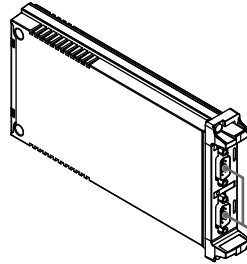

CAN bus/CAN FD bus
signal input terminal

**SENT Monitor Module
SENT (720243)**

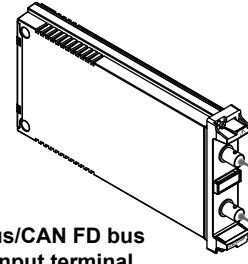

SENT signal
input terminal

**4-CH, 1 MS/s, 16-Bit
Isolation Module
4CH 1M16 (720254)**

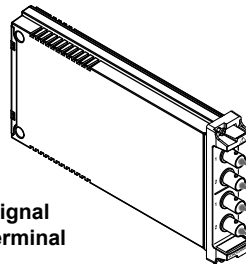

Signal input
terminal
(4ch)

1.2 Keys and Knobs

Vertical Scale

CH Key

Pressing this key displays an input channel setup menu. A channel selection area appears in the left side of the menu. The channel selected in the channel selection area is what you are configuring.

On this menu, you can turn on or off the channel input, set the display label, input coupling, probe attenuation/current-to-voltage conversion ratio, bandwidth limit, vertical zoom/wide, offset, linear scaling, and so on.

To change the channel that you are configuring, tap the desired channel in the channel selection area. You can also change the channel that you are configuring by turning the jog dial or pressing the ▲ and ▼ keys.

RT.MATH CH Key (/G03, /G05 option)

Pressing this key displays a real time math channel setup menu. A channel selection area appears in the left side of the menu. The channel selected in the channel selection area is what you are configuring. On this menu, you can turn or off the channel input, configure the real time math function, and so on.

ALL CH Key

Pressing this key displays a menu showing a list of all channel settings. You can collectively change the settings that are shown in the menu that appears by pressing the CH or RT.MATH CH key.

SCALE Knob

Use this knob to set the vertical scale. Before turning this knob, press the CH or RT.MATH CH key to select the target channel in the channel selection area. If you change the settings while waveform acquisition is stopped, the settings are applied when waveform acquisition is restarted.

◆ POSITION Knob (vertical position knob)

Use the POSITION knob to move the display position (vertical position) of the input waveform along the vertical axis. Before turning this knob, press the CH or RT.MATH CH key to select the target channel in the channel selection area. This knob has a push switch. You can press the knob to reset the position to the default value (0.00 div).

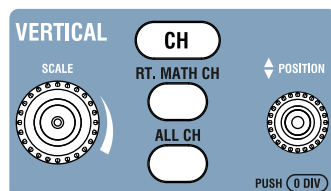

Horizontal Scale, Triggering

TIME/DIV Knob

Use this knob to set the time scale in Scope mode. When dual capture is enabled, the TIME/DIV knob controls the time scale of the high-speed waveform. If you change the settings while waveform acquisition is stopped, the settings are applied when acquisition is restarted.

MANUAL Key

Press this key to make this instrument trigger regardless of the trigger settings.

MENU (ACTION) Key

Press this key to display a menu for setting the trigger conditions, trigger position, and other trigger parameters. Press SHIFT and then MENU (ACTION) to display an action menu.

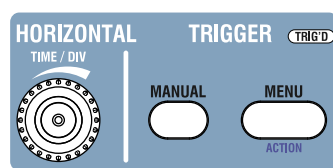

Waveform Acquisition

ACQUIRE (DUAL CAPTURE) Key

Press this key to display a menu for setting the waveform acquisition mode. Press SHIFT and then ACQUIRE (DUAL CAPTURE) to display a dual capture menu.



Waveform Measurement and Analysis

FFT (MATH) Key

Press this key to display an FFT computation menu. Press SHIFT and then FFT (MATH) to display a menu for waveform computation.

HISTORY (ANALYSIS) Key

Press this key to display a history feature menu used to recall data. Press SHIFT and then HISTORY (ANALYSIS) to display a menu for power analysis (/G05 option) or harmonic analysis (/G05 option).

MEASURE (GO/NO-GO) Key

Press this key to display a menu for automatic measurement of waveform parameters. Press SHIFT and then MEASURE (GO/NO-GO) to display a menu for GO/NO-GO determination.

CURSOR Key

Press this key to display a menu for making cursor measurements.



Waveform Zoom and Search

ZOOM (SEARCH) Key

Press this key to display a waveform zoom display menu. Press SHIFT and then press ZOOM (SEARCH) to display a data search (search & zoom feature) menu.

MAG Knob

In Scope mode, use this knob to set the zoom factor. In Recorder mode, use this knob to set the zoom factor and the duration of the waveform display section. This knob has a push switch.

When you press the MAG knob in Scope mode, the target zoom box for setting the zoom factor changes.

If you press the MAG knob when the zoom window is displayed in Recorder mode, the item you are setting switches between the duration of the waveform display section (for Z1) and zoom factor (for Z2).

◀POSITION▶ Knob (zoom POSITION knob)

In Scope mode, use this knob to set the zoom position. In Recorder mode, use this knob to set the zoom position and the position of the waveform display section. This knob has a push switch. When you press the POSITION knob in Scope mode, the target zoom box for setting the zoom position changes.

If you press the POSITION knob when the zoom window is displayed in Recorder mode, the item you are setting switches between the position of the waveform display section (for Z1) and zoom position (for Z2).

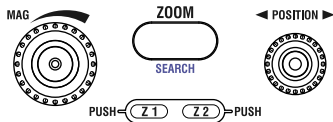

Notes about the Operation of Knobs with Push Switches

The following knobs have push switches: vertical scale POSITION knob, ZOOM MAG knob, and ZOOM POSITION knob. Push the knobs straight. If you push a knob at an angle, it may not operate properly. If this happens, push the knob straight one more time.

CAUTION

Do not push a knob sideways with strong force. If you do, the knob may break.

French

ATTENTION

Ne pas pousser violemment un bouton sur le côté. Cela pourrait les endommager, voire les casser.

Menu Operation and Waveform Acquisition Start/Stop

ESC Key

Use this key to close setup menus and dialog boxes and to return to the menu level above the current one.

Soft Keys

Use the soft keys to select items in the setup menu shown on the screen.

Jog Dial

When configuring various settings, use the jog shuttle to set values, move cursors, and select items.

SET Key

Press this key to confirm the menu item selected with the jog dial. Press this key also to start entering numbers and characters.

Arrow Keys (▲▼▶◀ keys)

Press the ◀ and ▶ keys to move the cursor between digits when entering a number. Press the ▲ and ▼ keys to increase and decrease the number you are entering. Press the ▲, ▼, ▶, and ◀ keys to select settings.

RESET Key

Press this key to reset an entered value to its default value.

START/STOP Key

Press this key to start and stop waveform acquisition according to the trigger mode. The key is illuminated while the instrument is acquiring waveforms.

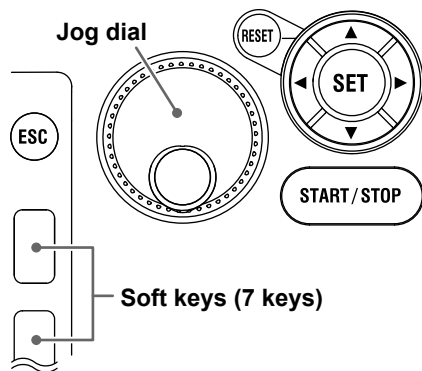

Other Operations

APPLICATION Key

By selecting an application from the available applications, you can set the necessary items in order according to the instructions on the screen.

SAVE (MENU) Key

Press this key to save waveform or screen capture data to a storage device. Press SHIFT and then SAVE (MENU) to display a menu for saving data.

IMAGE SAVE (MENU) Key

Press this key to print or save screen capture data. Press SHIFT and then IMAGE SAVE (MENU) to display a menu for printing screen capture data on a network or USB printer or saving the data to a storage device.

SETUP (CAL) Key

Press this key to display a menu for initializing various settings to their factory default values, perform auto setup (which automatically configures the settings according to the input signal), change the operation mode, store and recall setup data, and so on. Press SHIFT and then SETUP (CAL) to display a calibration menu.

DISPLAY (X-Y) Key

Press this key to display a menu for configuring the display. Press SHIFT and then DISPLAY (X-Y) to display a menu for the X-Y display.

FILE Key

Press this key to display a menu for saving and loading various types of data. On the Utility Menu, you can perform file operations such as copying and moving files in storage devices.

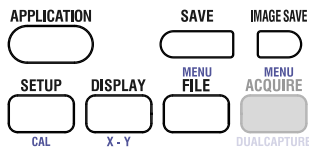

KEY PROTECT Key

Press this key to lock the front panel keys and the touch panel. Pressing this key causes the key to illuminate. Press the key again to clear that state.

HELP Key

Press this key to display and hide the help window, which explains various features.

SNAPSHOT Key

Press this key to retain the currently displayed waveforms on the screen in white (snapshot waveforms). Snapshot waveforms can be saved and loaded.

CLEAR TRACE Key

Press this key to clear all the waveforms that are displayed on the screen.

UTILITY Key

Press this key to display a menu for system configuration, communication configuration, network configuration, environment configuration, self-tests, and system information (input module information, available options, firmware version).

SHIFT key

Press this key once to illuminate it and access the features that are written in purple below each key. Press the key again to clear that state.



Note

Pressing SHIFT and then CLEAR TRACE clears the communication remote mode. For details, see the Communication Interface User's Manual, IM DL950-17EN.

1.3 Screens

Note

The instrument's LCD may include a few defective pixels. For details, see section 7.6, "Display."

Scope Mode Screen

Top menu¹

Measurement conditions²

Instrument status

Channel information⁵

- **Numeric monitor (DMM)**
Displays the measured value of the level indicator
- **Channel information (CH INFO)**
When dual capture is off
 - Vertical scale
 - Probe attenuation and current-to-voltage conversion ratio
 - Bandwidth limit
 - Sample rate
 - Input coupling
- When dual capture is on
 - Low-speed sampling sample rate
 - High-speed sampling sample rate

Set the channel information.

Set the width.

Turns the display on or off

Switches between numeric monitor and channel information

Measurement status²

Display group⁴

Level indicator

Trigger conditions²

Waveform display area³

- 1 Tap to display the top menu.
- 2 Tap to display a related setup menu.
- 3 Hold down to display a pop-up menu or drag waveforms and cursors.
- 4 Tap to switch the display group.
- 5 The channel being configured is enclosed in a blue frame. Tap the channel being configured to display the channel screen. Tap another channel to select the channel.
Drag to channel information display area vertically to scroll when the channels do not fit in the display area.

Pop-up Menu

When you perform the following operations in the waveform display area, a menu for that operation appears.

- **Hold down in the normal waveform display area.**

Zoom ON	Displays the zoom window
XY Window ON	Displays the X-Y window*
FFT ON	Displays the FFT window*

- **Hold down in the FFT window.**

FFT OFF	Clears the FFT window
FFT Menu	Displays the FFT menu

- **Hold down in the X-Y window.**

XY OFF	Clears the X-Y window
XY Menu	Displays the X-Y menu

- **Hold down in the zoom window.**

Zoom OFF	Clears the zoom window
↕	Increases the zoom factor.
↔	Moves the zoom position to the right edge of the main screen
↔	Moves the zoom position to the left edge of the main screen
↕	Decreases the zoom factor

* Only for high-speed sampling when dual capture is enabled

- **Tap the zoom box frame or drag horizontally in the zoom window**

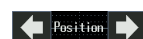

Moves the zoom position horizontally

- **Drag vertically in the waveform display area**



Moves the vertical position of the target waveform vertically

Measurement Conditions, Instrument Status (top of the screen)

When Dual Capture Is Off

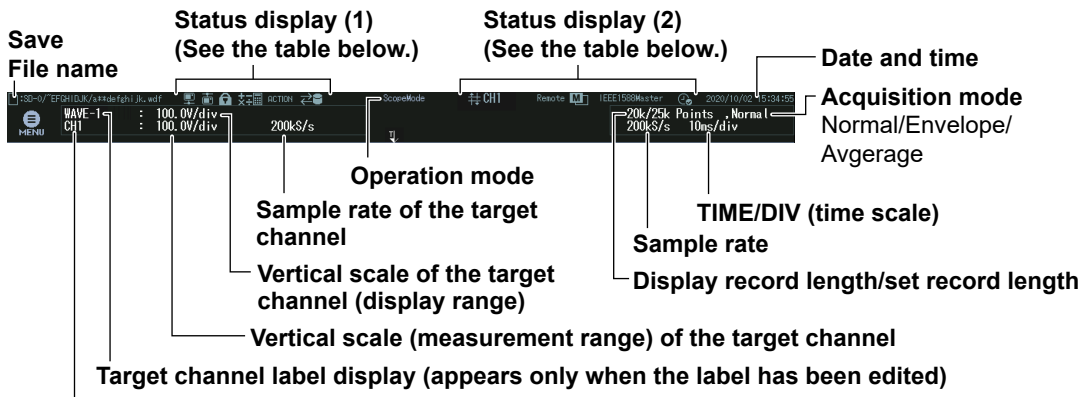

Channel being configured

Displayed as follows when the target channel input is off

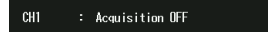

When Dual Capture Is On

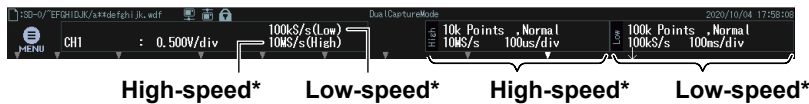

* The content of each item is the same as when dual capture is off. However, acquisition mode's high-speed sampling is fixed to Normal and low-speed sampling to Normal/Envelope.

• Status Display (1)

Icon Display	Description
	Illuminates when the instrument is connected to a network drive.
	Illuminates when the instrument is connected to an FTP client.
	Illuminates when the touch panel operation is disabled (off).
	Blinks while automated measurement of waveform parameters or waveform search is in progress.
	Blinks when files are being accessed.
	Blinks when printing is in progress.
	Blinks when SSD recording is in progress (/ST1 option).
	Blinks when an action is in progress.
	Blinks when math and FFT waveforms are being computed.

• Status Display (2)

Icon Display	Description
	Illuminates when the input signal is over-range. Over-range channels can be identified by the channel number shown to the right of the icon.
Remote	Illuminates in remote mode.
	Displays the time synchronization state. Each of the icons illuminates respectively when a sync signal is being received (Lock), when time synchronization is established (Stable), and when time synchronization is not established (UnLock).
	Displays the instrument status multi-unit synchronization operation (/C50 option). Each of the icons illuminates respectably when the instrument is running as a main or sub unit.
IEEE1588Master	Illuminates when the instrument is a IEEE1588 master (/C40 option).

Measurement Conditions and Trigger Conditions (bottom of the screen)

When Dual Capture Is Off

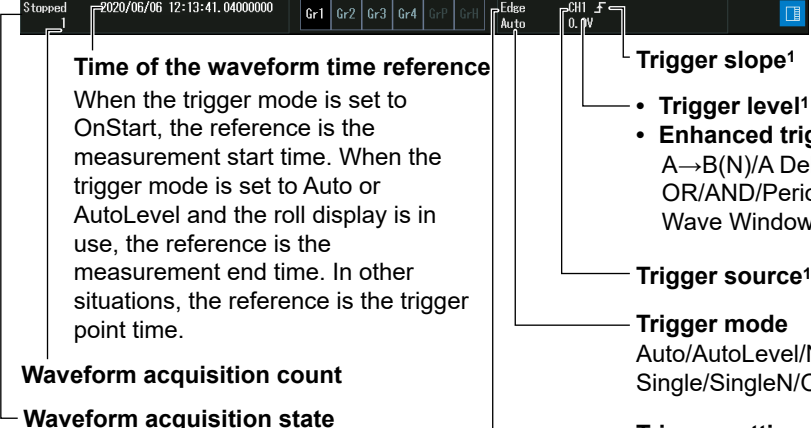

The screenshot shows the oscilloscope's measurement and trigger settings. The status bar at the top indicates 'Stopped' and '2020/06/06 12:13:41.04000000'. The trigger mode is set to 'Edge Auto' and the trigger level is '0.0V'. The trigger source is 'CH1'. The trigger settings are 'Auto/AutoLevel/Normal/Single/SingleN/OnStart'.

Time of the waveform time reference
When the trigger mode is set to OnStart, the reference is the measurement start time. When the trigger mode is set to Auto or AutoLevel and the roll display is in use, the reference is the measurement end time. In other situations, the reference is the trigger point time.

Waveform acquisition count

Waveform acquisition state
Stopped
Running
Waiting for trigger
Pre-Trigger: Acquiring pre-data
Post-Trigger: Acquiring post-data

Trigger slope¹

- Trigger level¹
- Enhanced trigger type²
A→B(N)/A Delay B/Edge On A/
OR/AND/Period/Pulse Width/
Wave Window

Trigger source¹

Trigger mode
Auto/AutoLevel/Normal/
Single/SingleN/OnStart

Trigger settings
Displayed as Edge only
for simple triggers.

- 1 Appears only for simple triggers (excluding OnStart)
- 2 Appears only for enhanced triggers (excluding OnStart)

When Dual Capture Is On

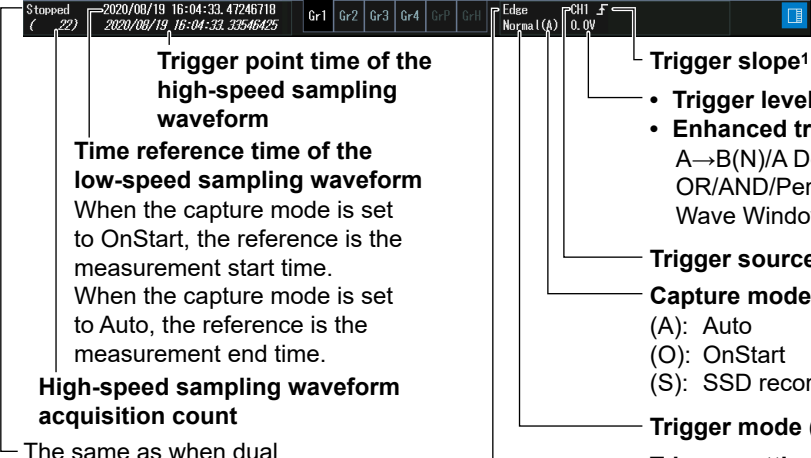

The screenshot shows the oscilloscope's measurement and trigger settings. The status bar at the top indicates 'Stopped (222)' and '2020/08/19 16:04:33.47246718'. The trigger mode is set to 'Edge Normal (A)' and the trigger level is '0.0V'. The trigger source is 'CH1'. The trigger settings are 'Auto/AutoLevel/Normal/Single/SingleN/OnStart'.

Trigger point time of the high-speed sampling waveform

Time reference time of the low-speed sampling waveform
When the capture mode is set to OnStart, the reference is the measurement start time.
When the capture mode is set to Auto, the reference is the measurement end time.

High-speed sampling waveform acquisition count

The same as when dual capture is off.

Trigger slope¹

- Trigger level¹
- Enhanced trigger type²
A→B(N)/A Delay B/Edge On A/
OR/AND/Period/Pulse Width/
Wave Window

Trigger source¹

Capture mode
(A): Auto
(O): OnStart
(S): SSD recording (fixed to OnStart)

Trigger mode (fixed to Normal)

Trigger settings
Displayed as Edge only
for simple triggers.

- 1 Appears only for simple triggers.
- 2 Appears only for enhanced triggers.

Waveform Display Area (center of the screen)

When Dual Capture Is Off

- Normal Waveform Display

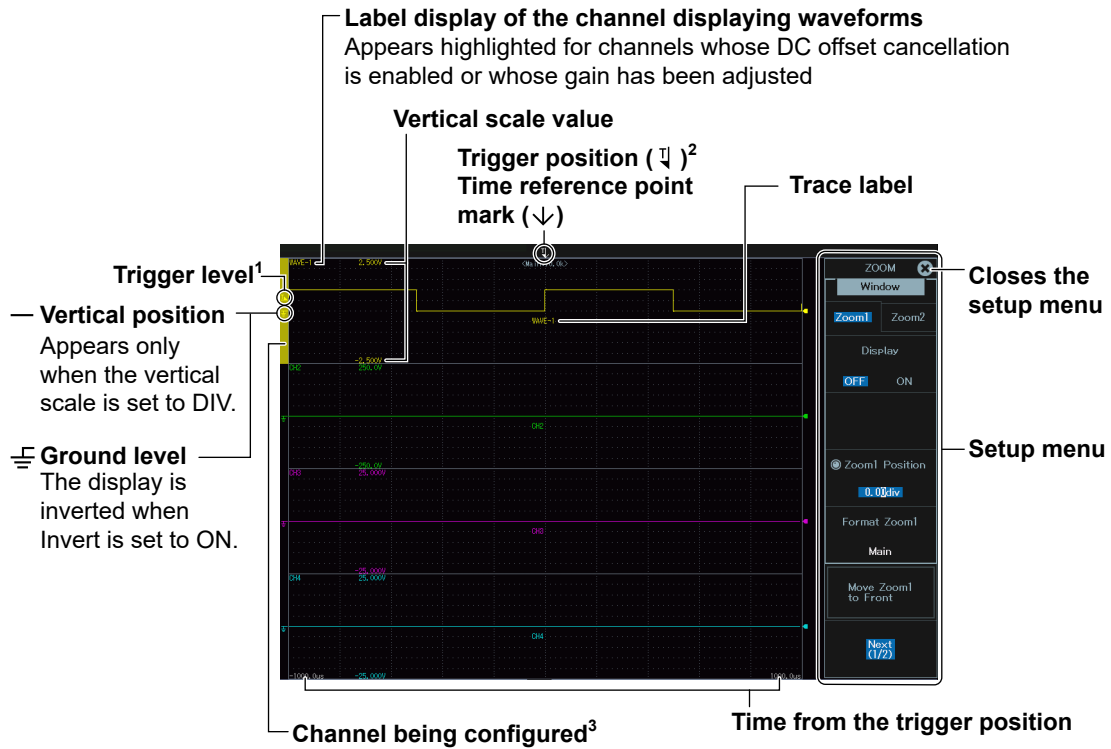

- Zoom Waveform Display

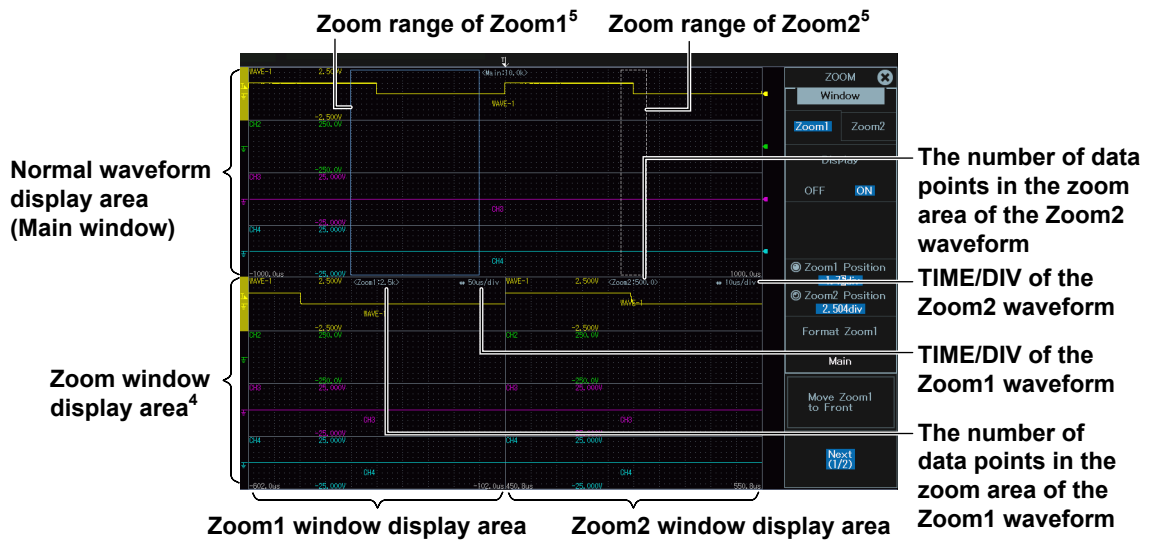

- 1 When you tap the trigger level, a horizontal line appears. You can drag the horizontal line vertically to change the level.
- 2 You can drag the trigger position horizontally to move it.
- 3 Displayed in the color of the channel being configured. When multiple waveforms are assigned, tapping causes the channel to be configured to be switched in order.
- 4 You can change the zoom window display layout. You can display a combination of up to two windows simultaneously. The available windows are the zoom window, X-Y window, and FFT window.
- 5 You can drag the zoom area (zoom box) frame horizontally to move the zoom position.

When Dual Capture Is On

• Normal Waveform Display

The same as when dual capture is off. ¹

Time from the reference point (0 ms)
When the capture mode is Auto, the right edge becomes the reference point (0 ms). When the capture mode is (On Start), the left edge becomes the reference point.

Time reference point mark (▼)

Low-speed sampling waveform display area

High-speed sampling waveform display area

Time from the trigger position

High-speed sampling trigger position¹

Time from the trigger position

Event mark (▼)
Displayed at the position where the high-speed sampling waveform was acquired when measurement is complete

Closes the setup menu

Setup menu

• Zoom Waveform Display

Low-speed sampling normal waveform display area

Low-speed sampling zoom window display area²

Low-speed sampling zoom area³

Low-speed sampling waveform display area

High-speed sampling normal waveform display area

High-speed sampling zoom window display area²

High-speed sampling zoom area³

High-speed sampling waveform display area

TIME/DIV of the low-speed sampling zoom waveform

The number of data points in the low-speed sampling zoom area

Time from the normal waveform reference point (0 ms)

TIME/DIV of the high-speed sampling zoom waveform

The number of data points in the high-speed sampling zoom area

- 1 You can change settings and other items by tapping. For details, see the screen when the dual capture is off.
- 2 You can change the zoom window display layout. For high-speed sampling, you can display a combination of two windows simultaneously. The available windows are the zoom window, X-Y window, and FFT window.
- 3 You can drag the zoom area (zoom box) frame horizontally to move the zoom position.

Recorder Mode Screen

The screenshot shows the Recorder Mode interface. At the top, there's a 'Top menu' and 'Instrument status' bar. Below is a large 'Waveform display area' showing a grid with waveforms. On the right, there's a 'Measurement conditions' section and a 'Channel information (CH INFO)' panel. At the bottom, there's a 'Measurement status' and 'Display group' section. A 'Level indicator' and 'Trigger conditions' are also visible.

Top menu¹

Instrument status

Measurement conditions²

Channel information⁵

- Numeric monitor (DMM)**
Displays the measured value of the level indicator
- Channel information (CH INFO)**
Vertical scale
Probe attenuation and current-to-voltage conversion ratio
Bandwidth limit
Sample rate
Input coupling

Set the channel information.

Set the width.

Turns the display on or off

Switches between numeric monitor and channel information

Measurement status²

Display group⁴

Level indicator

Trigger conditions²

Waveform display area³

- 1 Tap to display the top menu.
- 2 Tap to display a related setup menu.
- 3 Hold down to display a pop-up menu or drag waveforms and cursors.
- 4 Tap to switch the display group.
- 5 The channel being configured is enclosed in a blue frame. Tap the channel being configured to display the channel screen. Tap another channel to select the channel. Drag to channel information display area vertically to scroll when the channels do not fit in the display area.

Pop-up Menu

When you perform the following operations in the waveform display area, a menu for that operation appears.

- **Hold down in the normal waveform display area.**

Shrinks the waveform display section

Moves the waveform display section to the measurement end position

Moves the waveform display section to the measurement start position

Expands the waveform display section

- **Hold down in the zoom window.**

Zoom OFF — Clears the zoom window

Increases the zoom factor.

Moves the zoom position to the right edge of the main screen

Moves the zoom position to the left edge of the main screen

Decreases the zoom factor

- **Tap the zoom box frame or drag horizontally in the zoom window**

Position

Moves the zoom position horizontally

- **Drag vertically in the waveform display area**

Position

Moves the vertical position of the target waveform vertically

- **Tap the acquisition/record time bar.**

Position

Moves the waveform display section horizontally

- **Hold down in the FFT window.**

FFT OFF — Clears the FFT window

FFT Menu — Displays the FFT menu

- **Hold down in the X-Y window.**

XY OFF — Clears the X-Y window

XY Menu — Displays the X-Y menu

Measurement Conditions, Instrument Status (top of the screen)

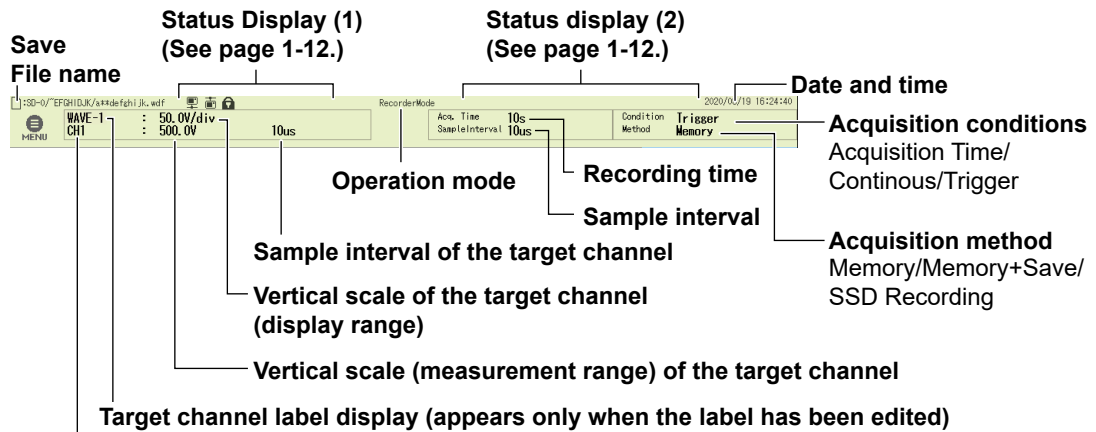

Channel being configured

Displayed as follows when the target channel input is off

CH1 : Acquisition OFF

Measurement Conditions and Trigger Conditions (bottom of the screen)

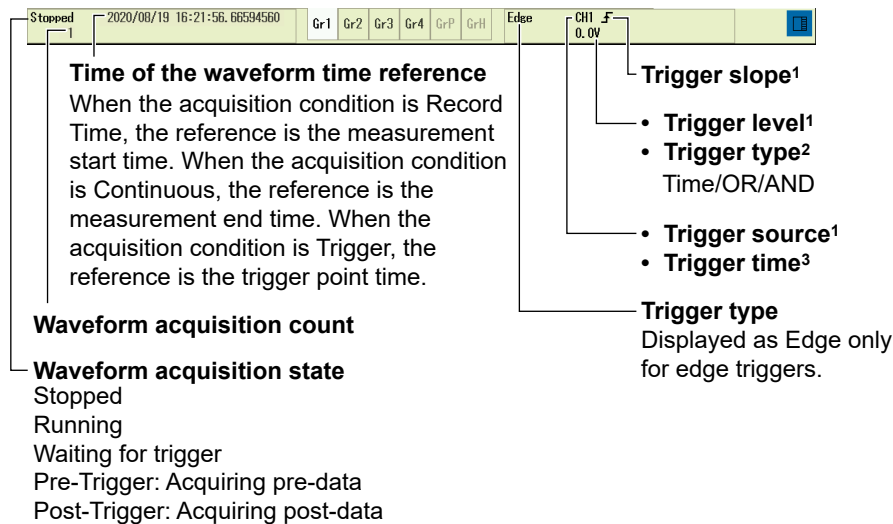

- 1 Appears only for edge triggers.
- 2 Appears for triggers other than edge.
- 3 The trigger time is displayed only for time triggers.

Waveform Display Area (center of the screen)

- **Normal Waveform Display**

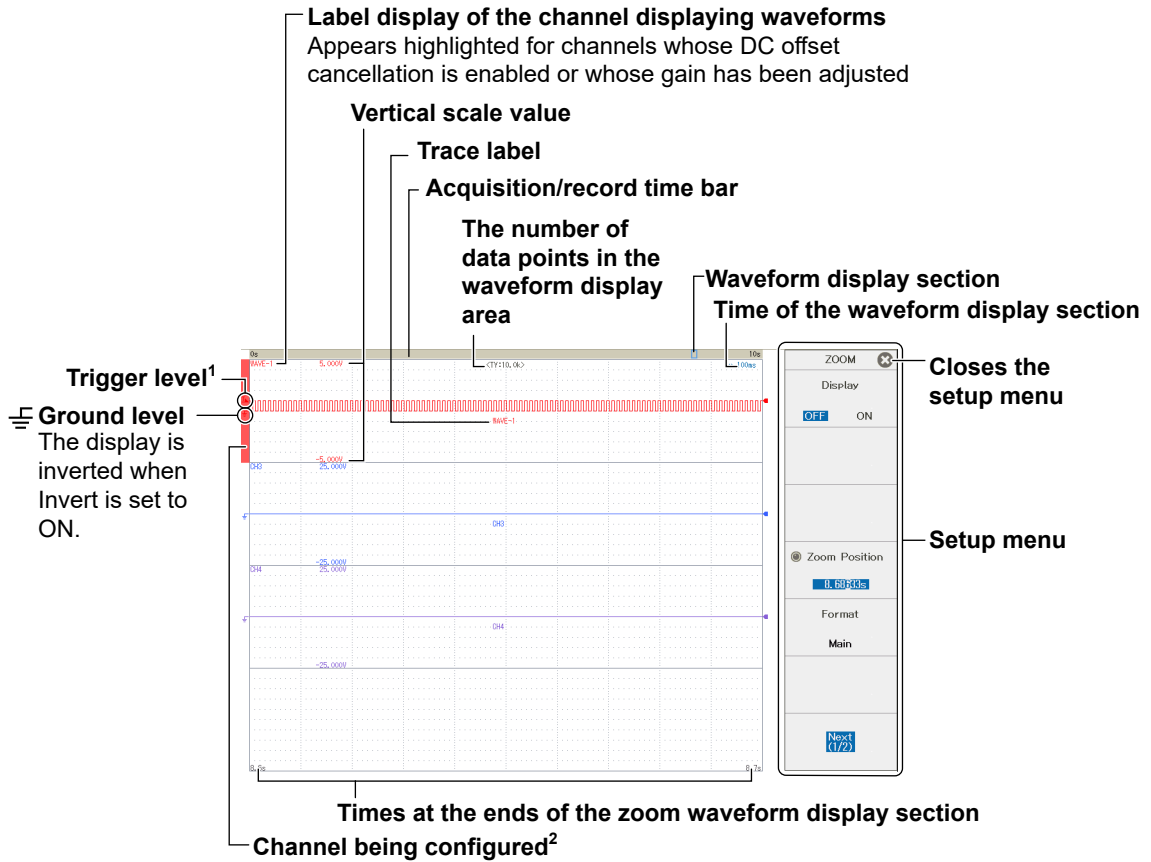

- **Zoom Waveform Display**

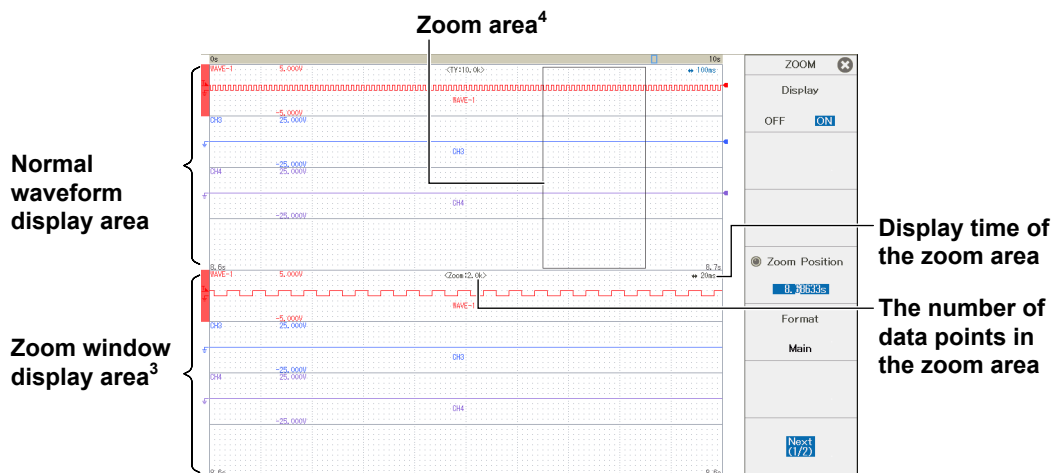

- 1 When you tap the trigger level, a horizontal line appears. You can drag the horizontal line vertically to change the level.
- 2 Displayed in the color of the channel being configured. When multiple waveforms are assigned, tapping causes the channel to be configured to be switched in order.
- 3 You can change the zoom window display layout. You can display a combination of up to two windows simultaneously. The available windows are the zoom window, X-Y window, and FFT window.
- 4 You can drag the zoom area (zoom box) frame horizontally to move the zoom position.

1.4 System Configuration

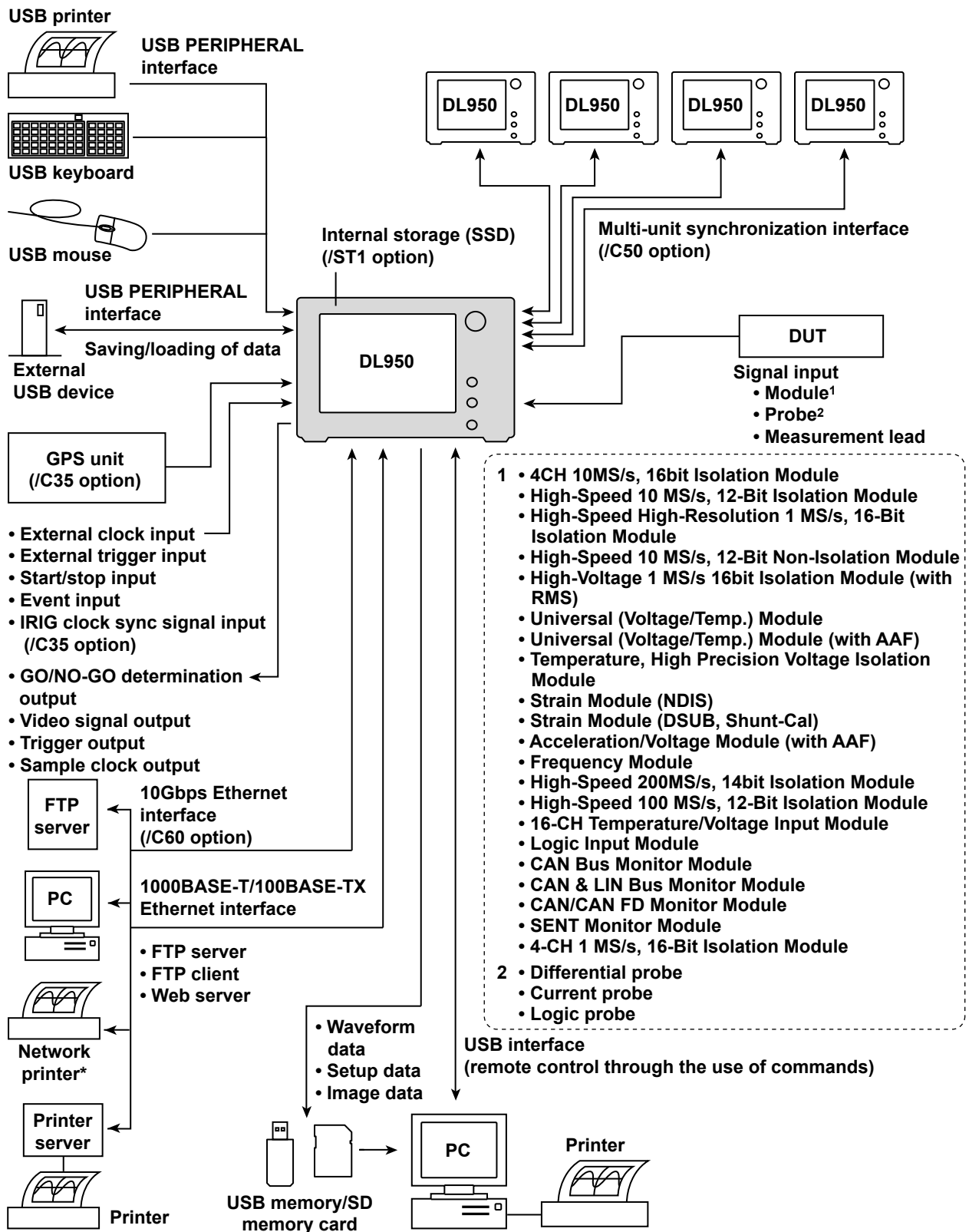

* 10Gbps Ethernet is not supported.

2.1 Operation Mode

This instrument can be used in the following two operation modes.

Scope Mode (Scope Mode)

Scope mode is used to set the time axis using Time/Div and record length. This is the typical time scale setting method for oscilloscopes.

Measurement is possible also in Dual Capture mode.

Recorder Mode (Recorder Mode)

Recorder mode is used to set the time axis using the measurement time and sampling interval. This is the typical time scale setting method for recorders.

2.2 Application Menu

The application menu is a feature that supports instrument configuration such as measurement conditions.

Even for measurements with numerous settings, settings can be appropriately configured without omissions as they can be set in order in a tutorial format. Various applications are available such as power analysis configuration and easy recording configuration. In addition, you can register applications that you frequently use from the available applications in favorites as well as load setup data that you stored through the SETUP menu.

Application menu

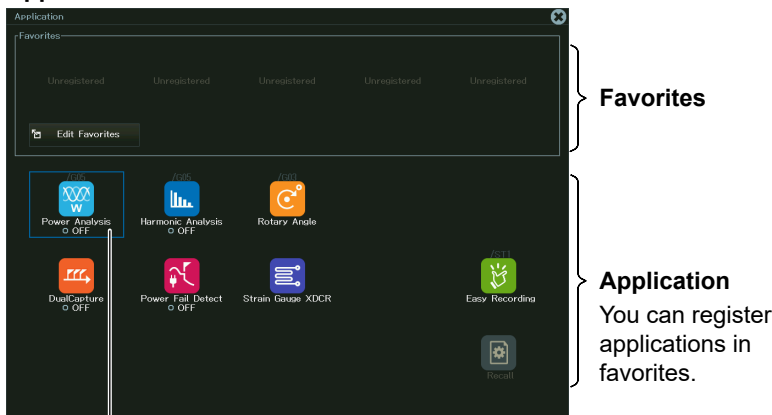

Power Analysis Setup Screen (Example)

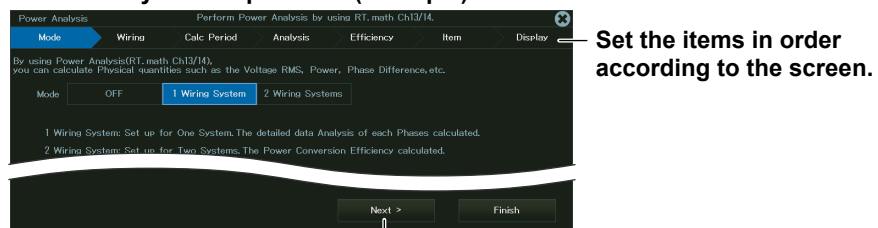

Displays the next setting

2.3 Channel Setup

Vertical Scale

This section explains how to configure the signal input settings and the amplitude-direction display settings. The items that can be set vary depending on the installed modules. A menu for the channel that you select (CH1 to CH16) appears. You can set the various vertical control settings for each channel. With the ALL CH menu, you can configure the settings of all channels while viewing the settings in a list.

Measurement Items

The following items can be measured depending on the modules installed in the instrument.

Measurement Items	Installed Module
Voltage	720256 (4CH 10M16), 701250 (HS10M12), 720250 (HS10M12), 701251 (HS1M16), 701255 (NONISO_10M12), 720268 (HV (AAF RMS)), 720212 (HS200M14), 720211 (HS100M12), 701261 (UNIVERSAL), 701262 (UNIVERSAL (AAF)), 701265 (TEMP/HPV), 720266 (TEMP/HPV), 701275 (ACCL/VOLT), 720221 (16CH TEMP/VOLT), 720254 (4CH 1M16)
Temperature	701261 (UNIVERSAL), 701262 (UNIVERSAL (AAF)), 701265 (TEMP/HPV), 720266 (TEMP/HPV)
Temperature (for the 16-CH Temperature/Voltage Input Module)	720221 (16CH TEMP/VOLT)
Strain	701270 (STRAIN_NDIS), 701271 (STRAIN_DSUB)
Acceleration	701275 (ACCL/VOLT)
Frequency	701281 (FREQ), 720281 (FREQ)
Logic	720230 (LOGIC)
CAN Bus signal monitoring*	720240 (CAN MONITOR), 720241 (CAN & LIN), 720242 (CAN/ CAN FD)
LIN Bus signal monitoring*	720241 (CAN & LIN)
CAN FD bus signal monitoring*	720242 (CAN/CAN FD)
SENT signal monitoring*	720243 (SENT)

* These modules can be used only with models with the /VCE option.

Vertical Scale

The vertical scale is used to adjust the displayed waveform amplitude so that you can easily view signals. Set the vertical scale for each channel.

- In Scope mode, set the time per grid division (1 div) displayed on the screen.
- In Recorder mode, set values from the top edge to the bottom edge of the waveform screen.

Vertical Position

Because the instrument can display many waveforms, the waveforms may overlap and be difficult to view. If this happens, you can adjust the vertical display position to make waveforms easier to view (vertical position). Set the vertical position for each channel.

Input Coupling

You can change the input coupling setting to match the signal that you are measuring. By changing the setting, you can choose how the vertical (voltage) control circuit is coupled to the input signal. The following types of input coupling are available: DC, AC, GND, TC, DC-RMS, AC-RMS, ACCEL, and OFF.* Set the appropriate input coupling for each input module.

* You can only select OFF for sub channels on the 16-CH Temperature/Voltage Input Module. Sub channels set to OFF are not measured.

Vertical Zoom

You can zoom the waveform vertically. You can zoom the waveform by setting the vertical magnification (Scope mode only) or by setting upper and lower display limits.

Linear Scaling

Linear scaling is a function that converts measured values into physical values and reads them directly. There two types of linear scaling:

AX+B

Using scaling coefficient A and offset B, the instrument scales values according to the equation below.

$Y = AX + B$ (where X is the measured value and Y is the physical value)

P1-P2

The instrument determines the scale conversion equation ($y = ax + b$) using four values that you specify: two measured values (P1[X], P2[X]) and the value that each one should be converted to (P1[Y], P2[Y]).

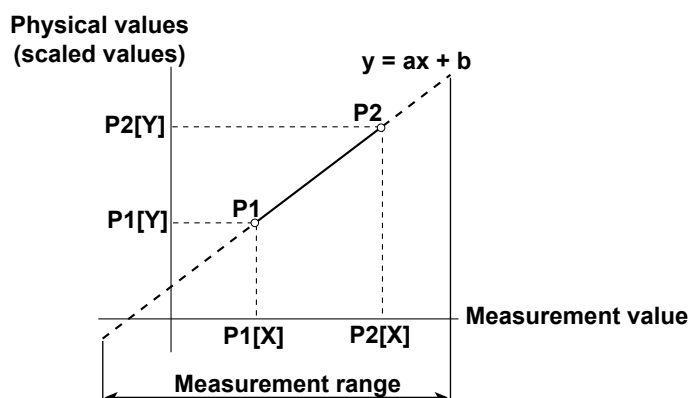

Sample Rate and Sample Interval

You can change the sample rate (Scope mode) or sample interval (Recorder mode) for each channel. Because waveform data are sampled and saved without changing the sample rate (determined by the record length and time scale) or sample interval set on the ACQUIRE menu, you can set these when you want to decrease the number of waveform data points that is saved.

For details, see page App-6.

2.4 Waveform Acquisition

Based on the data that has been stored in the acquisition memory, the instrument performs various operations, such as displaying waveforms on the screen, computing, measuring cursors, and automatically measuring waveform parameters.

You can set the number of data points to store in the acquisition memory (the record length), enable or disable the sample data averaging feature, and so on.

Horizontal Axis (Time Axis)

Scope Mode

Set the time axis using Time/Div and record length.

Time Scale (Time/Div)

Normally, with the default settings, the time scale is set as a length of time per grid division (1 div). Because the horizontal display range is 10 div, the amount of time on the waveform that is displayed is equal to the time scale \times 10.

Record length (Record Length)

Set the number of data points per waveform (record length) to acquire when acquiring data. The record length set on the ACQUIRE menu is referred to as the *set record length*. The acquisition memory is divided into compartments by the set record length, and waveforms are acquired in those compartments.

Display record length refers to the number of waveform data points that are actually stored to the acquisition memory.

The set record length and display record length are basically the same, but the display record length may be shorter depending on the time scale. The combination of the set record length and time scale determines the sample rate and display record length.

Recorder Mode

Set the time axis using the measurement time and sample interval.

Acquisition Time (Acquisition Time)/Record Time (Record Time)*

Record time is the length of time data is recorded. The time range to display waveforms (waveform display section) can be set separately from the record time.

* Acquisition time is a setting for memory recording. Record time is a setting for SSD recording.

Sample Interval (Sample Interval)

Sample interval is the interval at which data is acquired to the acquisition memory. The sample interval setting range varies depending on the record time.

Note

Sample Rate and Sample Interval

You can change the sample rate or sample interval of each channel in channel settings (see section 2.3).

Using the Appendix

- Appendixes 2 to 8 of this manual provide reference materials for that you can use when considering the measurement conditions for acquiring waveforms. For details, see appendix 1.
- For details on the relationship between the Scope mode's time scale, set record length, sample rate, and display record length, see appendix 2.
- For details on the relationship between the Recorder mode's acquisition time, record time, and sample interval, see appendix 8.

Internal and External Clocks (Time base selection)

With the initial settings, the instrument samples signals using the clock signal produced by its internal time-base circuit (internal clock).

You can also apply an external clock signal to control sampling. The external clock signal is applied through the external clock input terminal. This external clock input is useful for synchronizing to the clock signal of the waveform that is being measured.

Trigger Mode (Scope mode only)

The trigger mode determines the conditions for updating the displayed waveforms. There are six trigger modes: auto, auto level, normal, single, N single, and on-start. The trigger mode setting applies to all trigger types.

Roll mode display

When the trigger mode is Auto, Auto Level, Single, or On Start and the time scale is 100 ms/div or longer, instead of updating waveforms through triggering (update mode), the instrument displays the waveforms in roll mode. In roll mode, waveforms scroll from right to left.

Acquisition Conditions (Recorder mode only)

Set the acquisition start and end conditions. There are three types of acquisition conditions: acquisition time, continuous, and capture on trigger.

Acquisition Mode

Specify how the instrument processes sampled data, stores it in the acquisition memory, and uses it to display waveforms. In Scope mode, there are three modes: normal, envelope, and averaging. In Recorder mode, there are two modes: normal and envelope.

Note

Aliasing

If the sample rate is comparatively low with respect to the input signal frequency, the harmonics contained in the signal are lost. When this happens, some of the harmonics will be misread as low-frequency waves due to the effects described by the Nyquist sampling theorem. This phenomenon is called aliasing. You can avoid aliasing by acquiring signals at the highest possible sample rate or with the acquisition mode set to Envelope.

Dual Capture (Scope mode only)

Data acquisition at a high sample rate is possible while recording the trend in roll mode display at a low sample rate. This is effective when you want to capture high-speed phenomenon while observing the long-term trend.

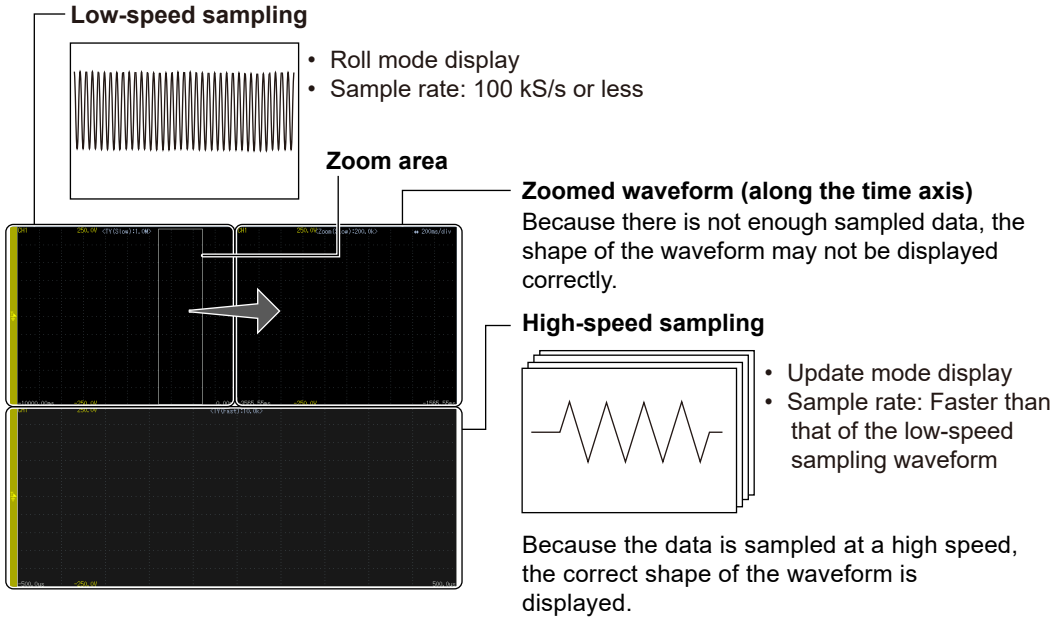

SSD Recording

Data can be recorded in sync with the start of a measurement to the SSD (/ST1 option), an internal storage space in the instrument. The recorded data is saved to files automatically. You can load the data that has been saved in this instrument.

SSD recording

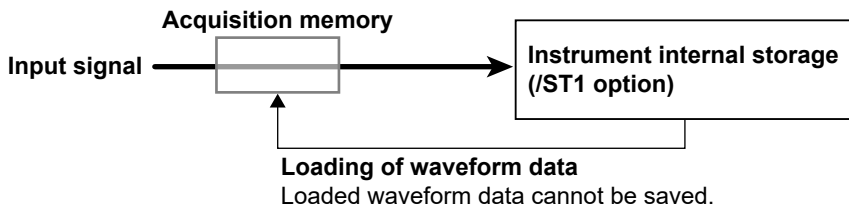

Normal measurement

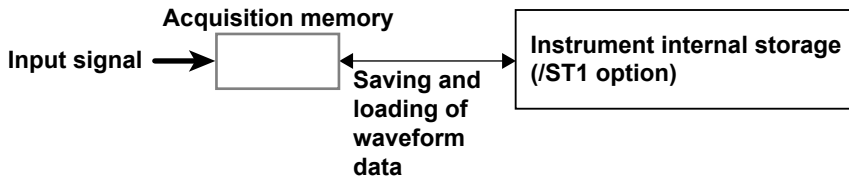

CAUTION

Do not store more than 513 files in the root directory of the internal storage. Doing so will slow the file access operations to all files. In addition, we cannot guarantee the operation of the SSD recording when the instrument is in this condition.

French

**ATTENTION**

Ne pas stocker plus de 513 fichiers dans le répertoire racine du stockage interne. Cela ralentira les opérations d'accès aux fichiers sur tous les fichiers. De plus, nous ne pouvons pas garantir l'opération de l'enregistrement SSD lorsque l'instrument est dans cette condition.

History (Scope mode only)

When waveforms are being measured, you can view the data in the form of waveforms as waveform data is acquired to the acquisition memory through triggers and displayed on the screen. When waveforms are being acquired through consecutive triggers, even if you notice an abnormal waveform and stop the acquisition, the screen will already have displayed a newer waveform. Normally, you cannot display the abnormal waveform by returning to the past. When you use the history feature, you can display past waveform data (history waveforms) in the acquisition memory when acquisition is stopped. You can display a specific history waveform from the history waveforms.

You can also search the history waveforms for waveforms that meet specific conditions.

- Zone Search

You can search for waveforms that pass (or not pass) through a specified search zone.

- Waveform Parameter Search

You can search for waveforms whose waveform parameter measurements meet (or not meet) specific conditions.

Zone search**History waveforms**

(up to 5000 waveforms)

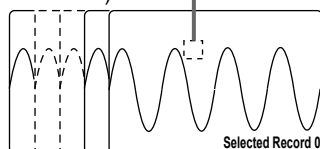

Waveforms that pass through the specified zone are detected.

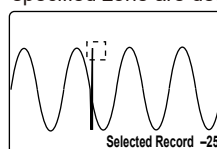
**Waveform parameter search****History waveforms**

(up to 5000 waveforms)

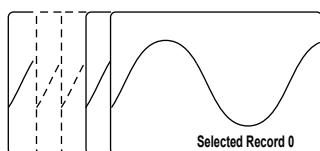

Waveforms that do not meet the specified search parameter conditions are detected.

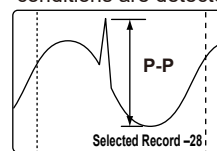

2.5 Triggering

Triggers are events used to display waveforms. A trigger occurs when the specified trigger condition is met, and a waveform is displayed on the screen.

Trigger Type

Scope Mode

There are two trigger types: simple and enhanced.

Simple Trigger

- **Input Signal Trigger**

The instrument triggers when the trigger source input signal passes through the specified trigger level in the specified way (rising edge, falling edge, or rising or falling edge).

- **Clock Trigger**

The instrument triggers at the specified date and time and at specified intervals afterwards.

- **External Signal Trigger**

The instrument triggers when the signal received through the TRIG IN terminal passes through the specified trigger level in the specified way (rising edge, falling edge, or rising or falling edge).

- **Power Line Signal Trigger**

The instrument triggers on the rising edge of the power signal supplied to the instrument. Waveforms can be observed in sync with the power line frequency.

Enhanced Trigger

- **A to B(N) Trigger**

After state condition A is met, the instrument triggers when state condition B is met N times.

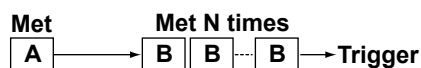

- **A Delay B Trigger**

After state condition B is met and the specified amount of time elapses, the instrument triggers when state condition A is first met.



- **Edge On A Trigger**

While state condition A is met, the instrument triggers on the OR of multiple trigger source edges.

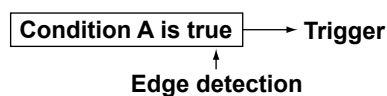

- **OR Trigger**

The instrument triggers on the OR of multiple trigger source edges.

- **AND Trigger**

The instrument triggers on the AND of multiple trigger source conditions. The instrument triggers when all the specified conditions are met at a single point.

- **Period Trigger**

The instrument triggers on a specified period of occurrence of state condition B. The instrument triggers when state condition B occurs again.

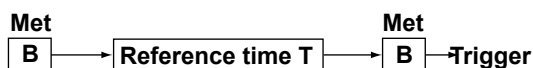

- **Pulse Width Trigger**

The instrument triggers according to the relationship between the state condition B achievement time and the specified reference times (Time or T1 and T2).

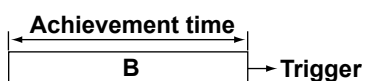

- **Wave Window Trigger**

The instrument creates real-time templates (Wave Window) using a number of cycles directly preceding the current waveforms. The instrument compares the current waveforms to the real-time templates and triggers if one of the current waveforms falls outside of its real-time template.

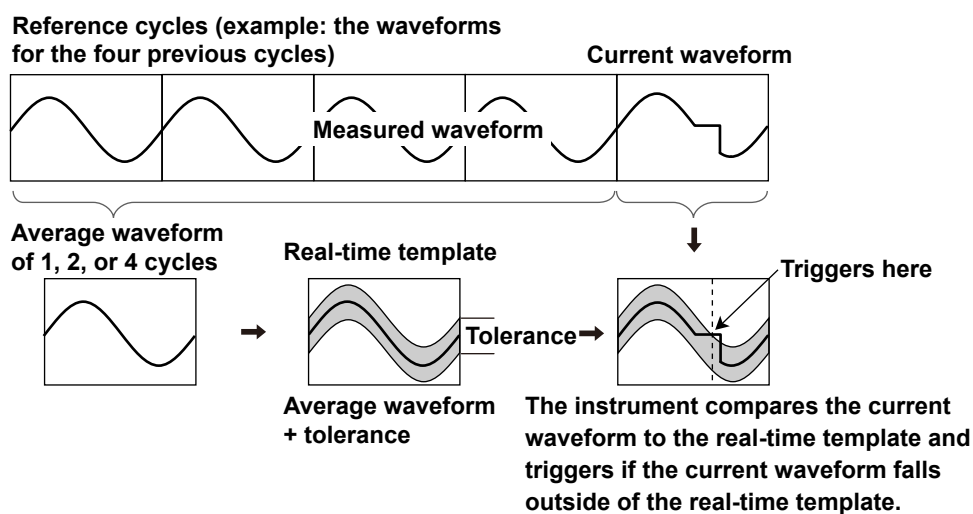

Recorder Mode

Edge Trigger

The instrument triggers when the trigger source input signal passes through the specified trigger level in the specified way (rising edge, falling edge, or rising or falling edge).

Clock Trigger

The instrument triggers at the specified date and time.

OR Trigger

The instrument triggers on the OR of multiple trigger source edges.

AND Trigger

The instrument triggers on the AND of multiple trigger source conditions. The instrument triggers when all the specified conditions are met at a single point.

Trigger Source

Trigger source refers to the signal used to determine whether the specified trigger conditions are met. You can set the trigger source to an analog signal, logic signal, real time math signal, time, external signal, or power line signal. Select the appropriate trigger source for the trigger type.

Trigger Slope

Slope refers to the movement of the signal from a low level to a high level (rising edge) or from a high level to a low level (falling edge). When a slope is used as one of the trigger conditions, it is called a *trigger slope*.

Trigger Level

Trigger level refers to the signal level used as a reference for detecting a signal's rising and falling edges or high and low states. With simple triggers such as the edge trigger, the instrument triggers when the trigger source level passes through the specified trigger level. The range and resolutions that you can use to set the trigger level vary depending on the type of signal being measured.

Trigger Hysteresis

When the trigger source is an analog signal, trigger hysteresis establishes a trigger level margin (hysteresis) so that the instrument does not trigger if the signal level change is within the margin. You can set the hysteresis around the trigger level for each type of measured signal.

Trigger Position (Scope mode only)

When you move the trigger position, the ratio of the displayed data before the trigger point (pre-data) to the data after the trigger point (post-data) changes. When the trigger delay is 0 s, the trigger point and trigger positions coincide.

Pre-trigger (Recorder mode only)

When the acquisition condition is set to Trigger, set the ratio of data before the trigger point (pre-data) to the entire waveform data.

Trigger Hold-off (Scope mode only)

The trigger hold-off feature temporarily stops the detection of the next trigger once a trigger has occurred. This feature is useful such as when you want to change the signal acquisition interval, such as when you are observing a pulse code modulation (PCM) code or other pulse train signal or when you are using the history feature.

Trigger Delay (Scope mode only)

The instrument normally displays waveforms before and after the trigger point. You can set a trigger delay to display waveforms a specified amount of time after the trigger occurrence.

2.6 Waveform Display

This instrument has a main window (which displays normal time-domain waveforms), zoom window (which displays zoomed time-domain waveforms), X-Y window (which displays X-Y waveforms), and so on. It also has a method of displaying waveforms and measured values that makes viewing easier by dividing the screen and changing the waveform display area as well as an FFT window, which displays FFT analysis results.

Time Scale Zoom (GIGAZoom)

You can magnify displayed waveforms along the time axis. This feature is useful when you set a long acquisition time and want to observe a portion of the waveform closely. In Scope mode (when dual capture is off), the zoomed waveforms of two locations can be displayed simultaneously (dual zoom).

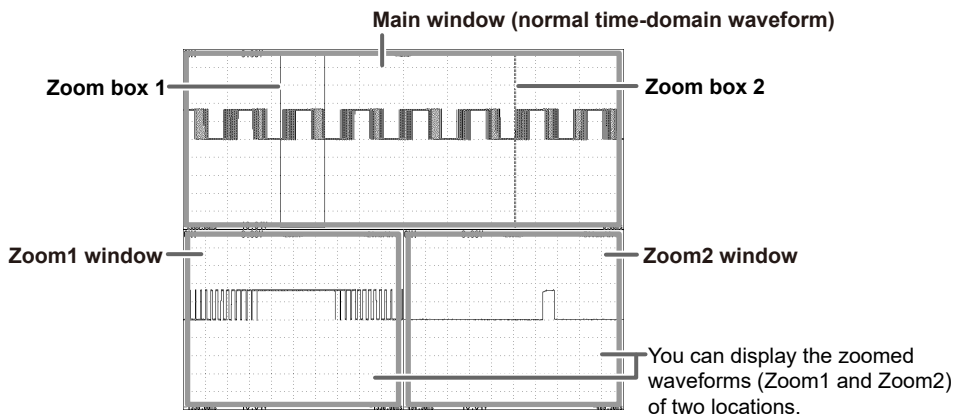

X-Y Waveform Display

You can observe the correlation between two waveform signal levels by displaying one signal level on the X-axis (horizontal axis) and a second signal level on the Y-axis (vertical axis). You can also observe X-Y waveforms and T-Y waveforms (waveforms based on the time scale and signal level). You can superimpose up to four X-Y waveforms in each of the windows Window1 and Window2. Because multiple X-Y waveforms can be displayed, it is easy to compare the relationships between phases. You can use this feature to evaluate DC motors using Lissajous waveforms.

Snapshot

You can continue displaying a waveform on the screen as a snapshot waveform after the screen has been updated and the waveform has been cleared in update mode or after the waveform has left the screen in roll mode. Snapshot waveforms appear in white. You can compare them with new waveforms. You can also save and print snapshot waveforms as screen captures.

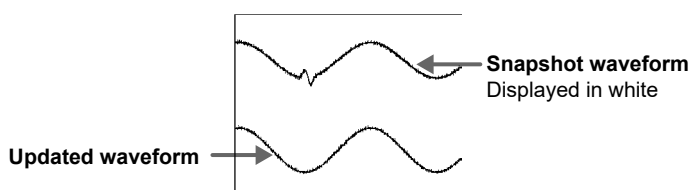

2.7 Waveform Computation and Analysis

Waveform Computation

Arithmetic operations (+, -, *, /), binarization, and phase shift are available. When the /G02 option is installed, abundant functions (square root, trigonometric functions, integration, digital filter, etc.) can be used to define up to eight expressions.

Expression configuration dialog box

Use the soft keyboard on the screen to enter an expression.

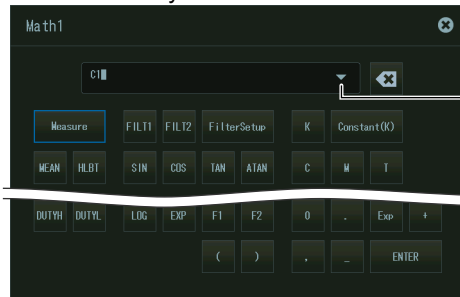

The entered expression is displayed.

Cursor Measurement

There are cursors for T-Y (time-axis), X-Y, and FFT waveforms. You can position a cursor over a waveform to view the various measured values at the intersection of the cursor and the waveform.

Automated Measurement of Waveform Parameters

You can use this feature to automatically measure waveform levels, maximum values, frequencies, and other values. 29 waveform parameters related to the voltage axis, time axis, and waveform area (including delay between channels) can be measured based on the waveform data.

- Up to 80 measured values can be displayed for all waveforms.
- Up to 64000 values can be saved for all waveforms.
- It is also possible to perform calculations using the automated measurement values of waveform parameters.
- You can display the following statistics for the specified waveform parameter.
- The maximum value (Maximum), minimum value (Minimum), average value (Average), standard deviation (SDev), and number of measured values used to calculate statistics (Count)

There are three statistical processing methods:

- Continuous statistical processing (Scope mode only*)
While acquiring waveforms, the instrument measures the measurement items and calculates the statistics of the waveforms that it has acquired so far.
- Cyclic statistical processing (measurement and statistical processing are performed for each period)
The instrument divides the waveform into periods starting at the left side of the screen (the oldest waveform) and moving to the right side of the screen, measures the selected measurement items within each period, and performs statistical processing on the measurement items.
- History waveform statistical processing (Scope mode only*)
The instrument measures the measurement items and calculates the statistics of history waveforms. Measurement and statistical processing begin with the oldest waveform.

* This applies only to high-speed sampling waveforms when dual capture is on.

Setup Dialog Box



Example of Displayed Statistical Values

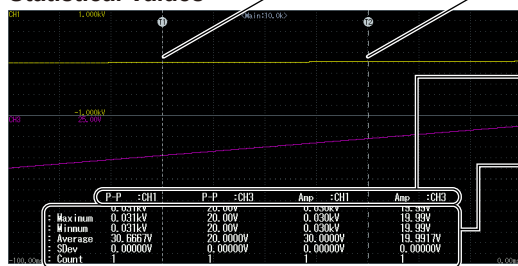

Set the measurement time range.

Measured items that the instrument is calculating the statistics of and the values of those items

Maximum, minimum, average
SDev: Standard deviation

Count: The number of measured values used to calculate statistics

FFT

The power spectrum of the input waveform can be displayed in the FFT window. There are two FFT windows, and up to eight FFT waveforms can be displayed (up to four in each FFT window). On models with the user-defined math function (/G02 option), various types of spectra can be analyzed in addition to the power spectrum.

GO/NO-GO Determination (Scope mode only)

This feature is useful for signal testing on production lines and for tracking down abnormal phenomena. The instrument determines whether the waveform enters the specified range. When the instrument returns a GO (or NO-GO) result, specified actions are performed.

Determination Methods

- Waveform Zone

The instrument returns GO/NO-GO results based on whether waveforms leave or enter the zone that you create using a base waveform.

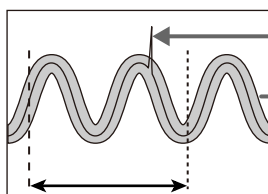

The instrument returns a GO or NO-GO judgment according to the determination condition.

Specified zone

Determination area

- Waveform Parameters

Upper and lower limits for automated measurement of waveform parameters are set, and GO/NO-GO determination is performed on whether the parameters are within or outside the range.

Actions Performed according to Determination Results

The instrument can save waveform data, save screen captures, beep, and send emails.

2.8 Digital Filter and Real Time Math Function (/G03, /G05 option)

The digital filter, and real time math functions can be used on models with the /G03 or /G05 option. The /G05 option expands the real time math function to include power math and harmonic analysis.

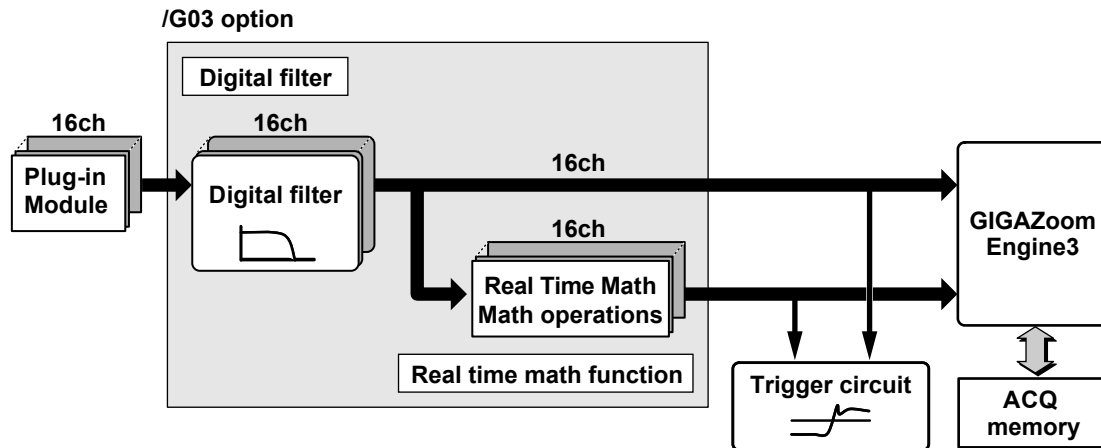

Digital Filter

You can apply digital filters on input channel waveforms (A/D converted data).

- This is set on each channel. You can perform filtering on up to 16 channels at the same time.
- Even during waveform acquisition, you can change the filter type, filter band, and cutoff frequency.
- By setting the waveform that results from filtering as a trigger source, you can trigger the instrument on the results.

Real Time Math Function

This function performs real time math operations in which the waveforms of input channels or the results of other real time math operations are used as the math source waveforms.

- This is set on each channel. You can perform math operations on up to 16 channels at the same time.
- Real time math results are output to real time math channels (RT.MATH CH), which are independent from input channels.
- Waveforms of real time math channels (real time math results) are used for displaying, saving, triggering, and analyzing (except for power math).
- Other real time math channels can be used as source waveforms of real time math. If you set the real time math channel to RTmathX, you can select the RTmath waveforms on channels up to RTmathX-1. If the real time math channel is RTmath1, you cannot use any other RMath waveforms as math source waveforms.
- The input channel of a 16-CH temperature/voltage input, CAN bus monitor, CAN/CAN FD monitor, CAN & LIN bus monitor, SENT monitor, or 4CH module can be used as a source waveform of real time math.
- When the power math feature (/G05 option) is in use, the power analysis results are output to RTmath13 and RTmath14, and harmonic analysis results are output to RTmath15 and RTmath16. The power analysis and harmonic analysis results cannot be used as source waveforms of real time math.

3.1 Handling Precautions

Safety Precautions

If you are using this instrument for the first time, make sure to thoroughly read the safety precautions given on page xiii.

Do Not Remove the Case

Do not remove the case from the instrument. Some sections inside the instrument have high voltages and are extremely dangerous. For internal inspection and adjustment, contact your nearest YOKOGAWA dealer.

Unplug If Abnormal Behavior Occurs

If you notice smoke or unusual odors coming from the instrument, immediately turn off the power and unplug the power cord. Then, contact your nearest YOKOGAWA dealer.

Do Not Damage the Power Cord

Nothing should be placed on top of the power cord, and it should be kept away from any heat sources. When removing the plug from the power outlet, do not pull on the cord. Pull from the plug. If the power cord is damaged or if you are using the instrument in a location where the power supply specifications are different, purchase a power cord that matches the specifications of the region that the instrument will be used in.

Operating Environment and Conditions

This instrument complies with the EMC standard under specific operating environment and operating conditions. If the installation, wiring, and so on are not appropriate, the compliance conditions of the EMC standard may not be met. In such cases, the user will be required to take appropriate measures.

General Handling Precautions

Do Not Place Objects on Top of the Instrument

Never place other instruments or objects containing water on top of the instrument, otherwise a breakdown may occur.

Do Not Apply Shock or Vibration

Do not apply shock or vibration. Doing so may damage the instrument. Applying shock to the input connectors, probes, and the like, can cause electrical noise to enter the instrument through the signal lines.

Do Not Damage the LCD

Because the LCD is very vulnerable and can be easily scratched, do not allow any sharp objects near it. Also it should not be exposed to vibrations and shocks.

Unplug during Extended Non-Use

Unplug the power cord from the outlet.

3.1 Handling Precautions

When Carrying the Instrument

Remove the power cord and connecting cables. When carrying the instrument, either hold the handle or hold the side grips firmly with both hands as shown in the figure below.

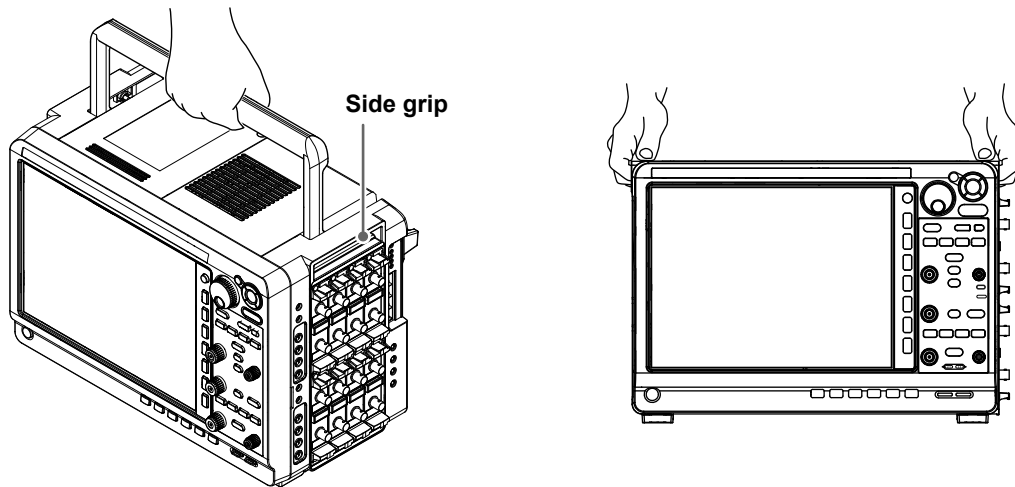

WARNING

- When you hold or put away the handle, be careful not to get your hand caught between the handle and the case.
 - When you carry the instrument, be careful not to get your hand caught between the wall, installation surface, or other objects and the instrument.
-

French

AVERTISSEMENT

- Lorsque vous attrapez ou rabattez la poignée, veillez à ne pas vous coincer la main entre la poignée et l'instrument.
 - Lorsque vous déplacez l'instrument, veillez à ne pas vous coincer la main entre l'instrument et le mur, la surface d'installation ou tout autre objet.
-

When Cleaning the Instrument

When cleaning the case or the operation panel, first remove the power cord from the outlet, and then wipe with a dry, soft, clean cloth. Do not use chemicals such as benzene or thinner. These can cause discoloring and deformation.

3.2 Installing the Instrument

WARNING

- Do not install the instrument outdoors or in locations subject to rain or water.
- Install the instrument so that you can immediately remove the power cord if an abnormal or dangerous condition occurs.

CAUTION

If you block the inlet or outlet holes on the instrument, it will become hot and may break down.

French

AVERTISSEMENT

- Ne pas installer l'instrument à l'extérieur ou dans des endroits exposés à la pluie ou à l'eau.
- Installer l'instrument de manière à pouvoir immédiatement le débrancher du secteur en cas de fonctionnement anormal ou dangereux.

ATTENTION

Ne pas boucher les orifices d'entrée ou de sortie de l'instrument pour éviter toute surchauffe et panne éventuelle.

Installation Conditions

Install the instrument in a place that meets the following conditions.

Flat, Even Surface

Install the instrument in the correct orientation (see page 3-5) in a safe place, with no tilting from front to back or left to right. However, horizontal installation or tilted installation using the stand are allowed.

3.2 Installing the Instrument

Well-Ventilated Location

There are inlet holes on the bottom side of the instrument. There are also vent holes for the cooling fan on the left side panel and top panel. To prevent internal overheating, allow for enough space around the instrument (see the figure below), and do not block the inlet and outlet holes.

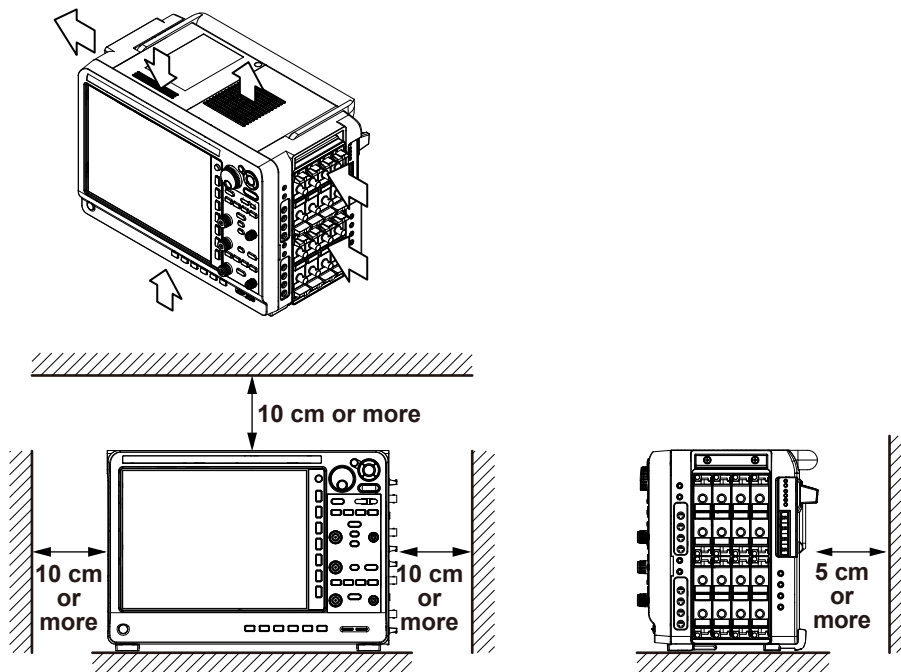

When connecting cables, allow for enough space, above and beyond the space shown in the figure above, to carry out the procedure.

Ambient Temperature and Humidity

Ambient temperature: 5 to 40 °C

Ambient humidity: 20 to 80 % RH; no condensation

Note

- To ensure high measurement accuracy, operate the instrument in the $23 \pm 5^\circ\text{C}$ temperature range and 20 to 80% RH.
- Condensation may occur if the instrument is moved to another place where the ambient temperature or humidity is higher, or if the temperature changes rapidly. In such cases, allow the instrument adjust to the new environment for at least an hour before using the instrument.

Do not install the instrument in the following places.

- Outdoors
- In direct sunlight or near heat sources
- Where the instrument is exposed to water or other liquids
- Where an excessive amount of soot, steam, dust, or corrosive gas is present.
- Near strong electromagnetic field sources
- Near high voltage equipment or power lines
- Where the level of mechanical vibration is high
- On an unstable surface

Installation Orientation

As shown in the following figure, vertical installation, horizontal installation, and tilted installation are possible. When using the movable legs or stand, push it out until it locks into place. To put away the stand, push it inward while returning it to its original position.

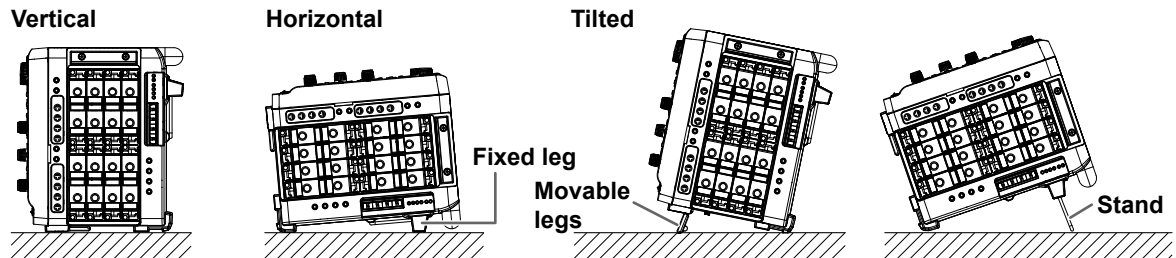

WARNING

- When you handle the movable legs, be careful not to injure your hand with the leg edges.
- When you put away the movable legs or stand, be careful not to get your hand caught between the movable legs or stand and the instrument.
- Handling the movable legs or stand without firmly supporting the instrument can be dangerous. Please take the following precautions.
 - Only handle the movable legs or stand when the instrument is on a stable surface.
 - Do not handle the movable legs or stand when the instrument is tilted.
- Do not place the instrument in any position other than those shown in the above figures. Also, do not stack the instrument.

CAUTION

Do not apply excessive force or shock to the stand. Doing so may break the stand support.

French

AVERTISSEMENT

- Lorsque vous manipulez les pieds escamotables, veillez à ne pas vous blesser la main.
- Lorsque vous rangez les pieds ou le support escamotable, veillez à ne pas vous coincer la main entre l'instrument et les pieds ou le support.
- Lorsque vous manipulez les pieds ou le support escamotable, soutenez toujours l'instrument fermement. Prendre les précautions suivantes.
 - Ne manipuler les pieds ou le support escamotable que lorsque l'instrument est placé sur une surface stable.
 - Ne pas manipuler les pieds ou le support escamotable lorsque l'instrument est incliné.
- Ne pas placer l'instrument dans des positions autres celles indiquées ci-dessus. Ne pas empiler l'instrument.

ATTENTION

Évitez d'appliquer une force excessive ou des chocs sur le support. Le système de soutien du support peut se casser.

Rubber Stoppers

A total of six rubber stoppers can be attached to the feet at the bottom of the instrument to prevent the instrument from sliding. Four B8088FR pieces and a set of B9989 EX (four pieces) are included as standard accessories. This instrument uses two B9989 EX pieces.

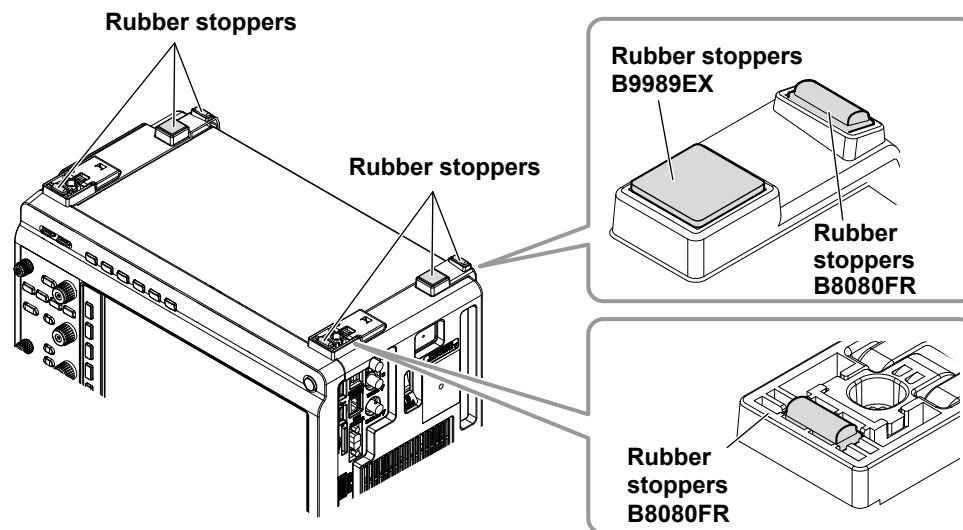

3.3 Installing Input Modules



WARNING

- To prevent electric shock and damage to the instrument, be sure to turn the power off before you install or remove input modules.
- Check that the input cable is not connected to the input terminals before installing or removing the input module.
- To prevent electric shock, be sure to attach the supplied cover panels to unused slots. This is also necessary as using the instrument without the cover panels allows dust to enter the instrument, which may cause a malfunction due to internal overheating.
- If the input module happens to come out of the slot while it is in use, it may cause electric shock or cause damage to the instrument as well as the input module. Make sure to screw the input module in place at the two locations (top and bottom).
- There are protrusions in the slot. Do not put your hand in the slot. If you put your hand in the slot, the protrusions may cut your hand.
- Use the accessories of this product within the rated range of each accessory (see page viii). When using several accessories together, use them within the specification range of the accessory with the lowest rating.

Precautions to Be Taken When Using the Modules

- Do not apply voltage exceeding the maximum input voltage or maximum rated voltage to ground.
- To avoid electric shock, be sure to ground the instrument.
- To prevent the possibility of electric shock, be sure to fasten the module screws. Failing to do so is extremely dangerous because the electrical and mechanical protection functions will not be activated.
- Avoid continuous connection in an environment where a surge voltage may occur.
- To measure high voltage with the 720256 (4CH 10M16), 701250 (HS10M12), 720250 (HS10M12), 701251 (HS1M16), 720212 (HS200M14), 720211 (HS100M12), or 720254 (4CH 1M16), use the isolated probes (700929, 701947), passive probes 702902, 1:1 safety cables (combination of 701901 and +701954), or differential probes (700924, 700925, 701926).
- Be sure to connect the ground lead of the differential probe (700924, 700925, 701926) to the functional grounding terminal of the instrument before connecting to the measurement target. Not doing so may cause high voltage to appear in the BNC connector of the differential probe.
- The 701977 and 701978 differential probes can only be used on the 701255 (NONISO_10M12) Non-Isolation Module. Using them on an isolation module may cause high voltage to appear in the BNC connector of the differential probe.
- The protection functions and non-isolation functions of the 701255 (NONISO_10M12) are enabled when the module screws are tightened. It is extremely dangerous if you do not fasten the screws. If you want to measure high voltages at 42 V or higher, be sure to use the 701940 passive probe or the 701977 or 701978 differential probe for this instrument.
- The 10 MHz 701940 passive probe has metal BNC parts. If you want to use it for isolated input (e.g., 720256 (4CH 10M16), 701250 (HS10M12), 720250 (HS10M12), 701251 (HS1M16), 701275 (ACCL/VOLT), 701281 (FREQ), 720281 (FREQ), 720212 (HS200M14), 720211 (HS100M12), 720254 (4CH 1M16)), use it under 42 V for safety reasons. (Do not connect either the high or low side to an electric potential at 42 V or higher.)
- When measuring high voltages using the 720268 (HV (AAF, RMS)), use a measurement lead 758933 or 701904 and alligator clip 701954.
- To measure high voltage with the 701281 (FREQ) or 720281 (FREQ), use an isolated probe (700929, 701947) or passive probe 702902.
- The protection functions and non-isolation functions of the 720230 (LOGIC) are enabled when the module screws are tightened. It is extremely dangerous if you do not fasten the screws. Also, be sure to only use one of the recommended YOKOGAWA logic probes (700986, 700987, 702911, or 702912) with the logic module.

French



AVERTISSEMENT

- Pour éviter tout risque de choc électrique et d'endommagement de l'instrument, veiller à mettre l'instrument hors tension avant d'installer ou de retirer des modules d'entrée.
- Avant d'installer ou de retirer des modules d'entrée, vérifier que le câble d'entrée n'est pas connecté aux bornes d'entrée.
- Pour éviter le choc électrique, veiller à fixer les panneaux de couverture fournis dans les fentes inutilisées.
Cela est également nécessaire car l'utilisation de l'instrument sans les panneaux de couverture permet à la poussière de pénétrer dans l'instrument, ce qui pourrait causer un dysfonctionnement à cause d'une surchauffe interne.
- Si le module d'entrée venait à sortir de son slot pendant son utilisation, cela pourrait entraîner un choc électrique ou endommager l'instrument et le module d'entrée. Veiller à bien visser le module d'entrée aux deux emplacements prévus (haut et bas).
- Les sots présentent des rebords en saillie. Ne pas insérer les doigts dans les slots, car les saillies pourraient vous blesser.
- Utilisez les accessoires de ce produit en fonction des valeurs nominales de chacun (reportez-vous à la page viii). Lorsque vous employez plusieurs accessoires en même temps, utilisez les valeurs de l'accessoire ayant les valeurs nominales les plus faibles.

Précautions à prendre lors de l'utilisation des modules

- Ne pas appliquer une tension dépassant la tension d'entrée maximum ou la tension nominale à la terre maximum.
- Pour éviter tout risque de choc électrique, l'instrument doit impérativement être relié à la terre.
- Pour éviter tout risque de choc électrique, toujours serrer les vis des modules, à défaut de quoi les fonctions de protection électrique et de protection mécanique ne seront pas activées.
- Évitez un branchement continu dans un environnement pouvant être soumis à une surtension.
- Lors de la mesure de tensions élevées à l'aide du 720256 (4CH 10M16), 701250 (HS10M12), 720250 (HS10M12), 701251 (HS1M16), 720212 (HS200M14), 720211 (HS100M12), ou 720254 (4CH 1M16), utiliser une sonde isolée (700929 ou 701947), un câble de sécurité 1:1 (701901 et +701954 conjointement) ou une sonde différentielle (700924, 700925 ou 701926).
- Veiller à connecter le fil de terre de la sonde différentielle (700924, 700925, 701926) à la borne de mise à la terre fonctionnelle de l'instrument avant de le connecter à la cible de mesure. Sinon, une haute tension pourrait causer dans le connecteur BNC de la sonde différentielle. Le fait de ne pas respecter cette consigne risque d'entraîner l'apparition d'une tension élevée au niveau du connecteur BNC de la sonde différentielle.
- Les sondes différentielles 701977 et 701978 ne peuvent être utilisées que sur le module non-isolation 701255 (NONISO_10M12). Leur utilisation sur un module d'isolation pourrait causer l'apparition d'une haute tension dans le connecteur BNC de la sonde différentielle.
- Lors de l'utilisation du 701255 (NONISO_10M12), veillez à serrer les vis du module. Le serrage des vis de module active la fonction de protection et celle de non-isolation. Il est extrêmement dangereux si vous ne serrez pas les vis. Si vous souhaitez mesurer des tensions élevées à 42 V ou plus, veillez à utiliser la sonde passive 701940 ou la sonde différentielle 701977 ou 701978 pour cet instrument.
- La sonde passive 10 MHz 701940 comporte des pièces BNC métalliques. Si vous souhaitez l'utiliser pour une entrée isolée (par exemple, 720256 (4CH 10M16), 701250 (HS10M12), 720250 (HS10M12), 701251 (HS1M16), 701275 (ACCL / VOLT), 701281 (FREQ), 720281 (FREQ), 720212 (HS200M14), 720211 (HS100M12), 720254 (4CH 1M16)), utilisez-le sous 42 V pour la sécurité. (Ne connectez ni le côté haut ni le côté bas à un potentiel électrique de 42 V ou plus.)
- Lors de la mesure de hautes tensions avec le 720268 (HV (AAF, RMS)), utiliser un cordon de mesure 758933 ou 701904 et une pince crocodile 701954.
- Pour mesurer la tension élevée avec 701281 (FREQ) ou 720281 (FREQ), utiliser une sonde isolée (700929, 701947) ou une sonde passive 702902.

- Les fonctions de protection et les fonctions de non-isolation de 720230 (LOGIC) sont activées lorsque les vis du module sont serrées. Il est extrêmement dangereux si vous ne serrez pas les vis. S'assurer également de bien utiliser uniquement une sonde logique YOKOGAWA recommandée (700986, 700987, 702911 ou 702912) avec le module logique.

Types of Input Modules

The following types of input modules are available.

Name	Model
4CH 10MS/s, 16bit Isolation Module	720256 (4CH10M16)
High-Speed 10 MS/s, 12-Bit Isolation Module	701250 (HS10M12)
High-Speed 10 MS/s, 12-Bit Isolation Module	720250 (HS10M12)
High-Speed High-Resolution 1 MS/s, 16-Bit Isolation Module	701251 (HS1M16)
High-Speed 10 MS/s, 12-Bit Non-Isolation Module	701255 (NONISO_10M12)
High-Voltage 1 MS/s 16-Bit Isolation Module (with AAF and RMS)	720268 (HV (AAF, RMS))
Universal (Voltage/Temp.) Module	701261 (UNIVERSAL)
Universal (Voltage/Temp.) Module (with AAF)	701262 (UNIVERSAL (AAF))
Temperature, High Precision Voltage Isolation Module	701265 (TEMP/HPV)
Temperature, High Precision Voltage Isolation Module (low noise)	720266 (TEMP/HPV)
Strain Module (NDIS)	701270 (STRAIN_NDIS)
Strain Module (DSUB, Shunt-Cal)	701271 (STRAIN_DSUB)
Acceleration/Voltage Module (with AAF)	701275 (ACCL/VOLT)
Frequency Module	701281 (FREQ)
Frequency Module	720281 (FREQ)
High-Speed 200MS/s, 14bit Isolation Module	720212 (HS200M14)
High-Speed 100 MS/s, 12-Bit Isolation Module	720211 (HS100M12)
16-CH Temperature/Voltage Input Module	720221 (16CH TEMP/VOLT)
Logic Input Module	720230 (LOGIC)
CAN Bus Monitor Module*	720240 (CAN MONITOR)
CAN & LIN Bus Monitor Module*	720241 (CAN & LIN)
CAN/CAN FD Monitor Module*	720242 (CAN/CAN FD)
SENT Monitor Module*	720243 (SENT)
4-CH 1 MS/s, 16-Bit Isolation Module	720254 (4CH 1M16)

* The CAN bus monitor, CAN&LIN bus monitor, CAN/CAN FD monitor, and SENT monitor modules can be used on models with the /VCE option.

Precautions to Be Taken When Installing or Removing Input Modules

If you replace one installed input module with another, the settings for the channel will be reset to their defaults when the power is turned on. If you want to keep the settings, specify a save destination and save them.

Installation Procedure of Modules

1. Make sure that the instrument's power switch is turned off.
2. Check the channel number displayed on the input module installation slot on the right side panel of the instrument, and then install the input module along the guide.

Holding the handles on the top and bottom of the input module, press hard until it clicks in place. If there is a cover panel on the slot in which to install the module, remove the cover panel, first.

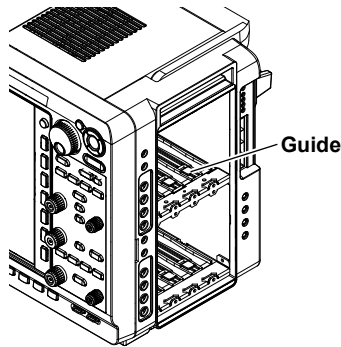

3. Firmly fasten the screws at top and bottom of the input module to fix the module in place.
Screw tightening torque: 0.6 N·m
4. Turn on the instrument's power switch.
5. In the overview screen, check that the name of the input module that you installed is displayed correctly at the appropriate slot. If it is not correct, remove the module according to the steps in "Removal" shown below, and reinstall the module according to steps 1 to 3 shown above.
To display the overview screen, see section 6.4, "Viewing System Information (Overview)."

Note

- You can install up to four 720243 SENT Bus Monitor Modules in the bottom-row slots.
 - You can install up to two 720240 CAN bus monitor modules (CAN MONITOR), 720242 CAN/CAN FD monitor modules (CAN/CAN FD), or 720241 CAN & LIN bus monitor modules (CAN & LIN). These monitor modules can only be installed in slots 7 and 8.
-

Removing Elements

1. Make sure that the instrument's power switch is turned off.
2. Loosen the two screws that are fastened to the input module.
3. Hold the two handles at the top and bottom of the input module, and pull it out.

About the High-Speed, 200 MS/s, 14-bit Isolated Module and High-Speed, 100 MS/s, 12-bit Isolated Module

Safety Precautions for Laser Products

The High-Speed, 200 MS/s, 14-bit Isolated Module (720212 (HS200M14)) and High-Speed 100 MS/s, 12-Bit Isolation Module (720211 (HS100M12)) use an internal laser light source. The 720212 (HS200M14)) and 720211 (HS100M12) are class 1 laser products as defined by IEC 60825-1: Safety of Laser Products—Part1: Equipment Classification, and Requirements. In addition, this instrument complies with FDA performance standards for laser products except for deviations pursuant to Laser Notice No. 50, dated June 24, 2007.

High-Speed 200MS/s, 14bit Isolation Module (720212 (HS200M14))

The following information is printed on the side.



Complies with 21 CFR 1040.10 and 1040.11
except for deviations pursuant to Laser
Notice No.50, dated June 24, 2007
4-9-8 Myojin-cho, Hachioji-shi, Tokyo 192-8566, Japan

High-Speed 100 MS/s, 12-Bit Isolation Module (720211 (HS100M12))

The following information is printed on the side.

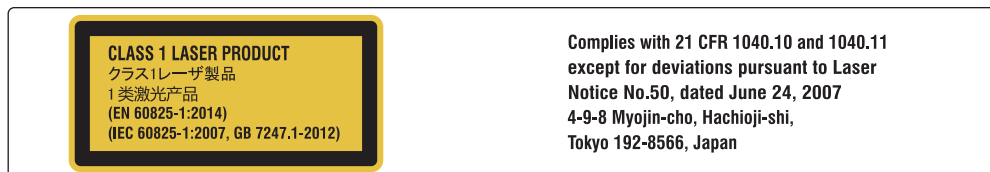

Complies with 21 CFR 1040.10 and 1040.11
except for deviations pursuant to Laser
Notice No.50, dated June 24, 2007
4-9-8 Myojin-cho, Hachioji-shi,
Tokyo 192-8566, Japan

DL950

The following information is printed on the top panel.

IF CLASS 1 LASER PRODUCT MODULE IS AVAILABLE

クラス1レーザーモジュール実装時
安装Class 1激光模块时



Complies with 21 CFR 1040.10 and 1040.11
except for deviations pursuant to Laser
Notice No.50, dated June 24, 2007
4-9-8 Myojin-cho, Hachioji-shi, Tokyo 192-8566, Japan

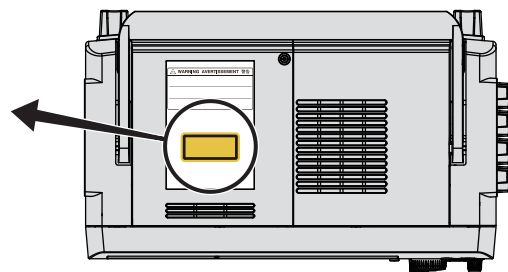

If the instrument is used in a manner not specified in this manual, the protection provided by the instrument may be impaired. YOKOGAWA assumes no liability for the customer's failure to comply with these warnings and requirements.

LEDs on the Frequency Module and SENT Monitor Module

On the front panel of the frequency module (701281 (FREQ)/720281 (FREQ)) and SENT monitor module (720243 (SENT)) are LEDs for each channel. These LEDs allow you to check the input condition of the pulse.

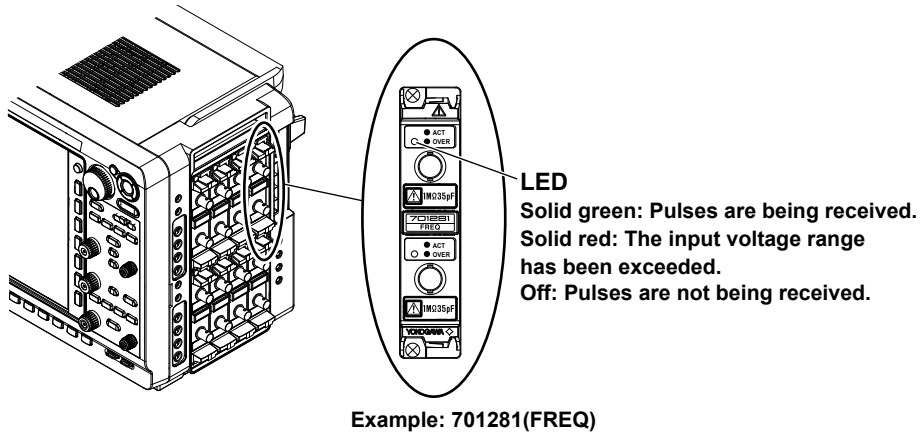

Note

- The LEDs on the frequency module and SENT monitor module illuminates in green when pulse is applied and red when the input voltage level is over range. It is independent of the start/stop condition of waveform acquisition of the instrument.
 - When the preset of the frequency module is set to EM Pickup (electromagnetic pickup), the LED will not illuminate in red when the range is exceeded.
For information about presets, see section 2.7, "Configuring Frequency, Revolution, Period, Duty Cycle, Power Supply Frequency, Pulse Width, Pulse Integration, and Velocity Measurements," in the user's manual.
-

Connection Cables

The following table shows the cables that can be used with various input modules.

Input Module	Voltage Probe ¹		Current Probe ¹	Clamp-on Probe ¹	Differential Probe ¹		Safety Cable, ¹ Measurement Lead ²			Other ⁴
	700929, 702902, 701947	701940			701930, 701931, 701932, 701933, 701917, 701918, 702915, 702916	720930, 720931	700924, ³ 700925, ³ 701926 ³	701977, 701978	701901	
720256	Y	—	Y	Y	Y	—	Y	—	—	—
701250	Y	—	Y	Y	Y	—	Y	—	—	—
720250	Y	—	Y	Y	Y	—	Y	—	—	—
701251	Y	—	Y	Y	Y	—	Y	—	—	—
701255	—	Y	Y	Y	Y	Y	—	Y	—	—
720268	—	—	—	—	—	—	—	—	Y	—
701261, 701262, 701265, 720266, 701270, 701271	—	—	—	—	—	—	—	—	—	Y
701275	—	Y	Y	Y	Y	—	—	Y	—	—
701281	Y	—	—	—	—	—	Y	—	—	—
720281	Y	—	—	—	—	—	Y	—	—	—
720212	Y	—	Y	Y	Y	—	Y	—	—	—
720211	Y	—	Y	Y	Y	—	Y	—	—	—
720221, 720230, 720240, 720241, 720242	—	—	—	—	—	—	—	—	—	Y
720243	Y	—	—	—	—	—	Y	—	—	—
720254	Y	—	Y	Y	Y	—	Y	—	—	—

¹ For instructions on how to connect probes or BNC cables, see section 3.6.

² For instructions on how to connect measurement leads, see section 3.8.

³ Discontinued.

⁴ Connect a thermocouple, bridgehead, sensor, and so on depending on the input module. For the connection procedure, see sections 3.9 and 3.16.

3.4 Connecting the Power Supply

Before Connecting the Power Supply

Make sure to follow the warnings below when connecting the power supply. Failure to do so may cause electric shock or damage to the instrument.



WARNING

- First, ensure that the source voltage matches the rated supply voltage of the instrument and that it is within the maximum rated voltage of the power cord you will use. Then connect the power cord.
 - Connect the power cord after checking that the power switch of the instrument is turned off.
 - To prevent electric shock and fire, use the power cord for this instrument.
 - To prevent electric shock, make sure to ground the instrument. Connect the power cord to a three-prong power outlet with a protective earth terminal.
 - Do not use an ungrounded extension cord. If you do, the instrument will not be grounded.
 - If there is no AC outlet that is compatible with the power cord that you will be using and you cannot ground the instrument, do not use the instrument.
-

French



AVERTISSEMENT

- Assurez-vous que la tension d'alimentation correspond à la tension d'alimentation nominale de l'appareil et qu'elle ne dépasse pas la plage de tension maximale du cordon d'alimentation à utiliser.
 - Brancher le cordon d'alimentation après avoir vérifié que l'interrupteur d'alimentation de l'instrument est sur OFF.
 - Pour éviter tout risque de choc électrique, utiliser exclusivement le cordon d'alimentation prévu pour cet instrument.
 - Pour éviter tout risque de choc électrique, l'instrument doit impérativement être relié à la terre. Brancher le cordon d'alimentation sur une prise de courant à trois plots reliée à la terre.
 - Toujours utiliser une rallonge avec broche de mise à la terre, à défaut de quoi l'instrument ne serait pas relié à la terre.
 - Si une sortie CA conforme au câble d'alimentation fourni n'est pas disponible et que vous ne pouvez pas relier l'instrument à la terre, ne l'utilisez pas.
-

Connecting the Power Cord

1. Check that the main power switch on the left side panel of the instrument is turned off.
2. Connect the power cord plug to the power connector on the left side panel.
3. Connect the other end of the cord to an outlet that meets the following conditions. Use a grounded three-prong outlet.

Rated supply voltage*	100 to 120 VAC/200 to 240 VAC
Permitted supply voltage range	90 to 132 VAC/198 to 264 VAC
Rated supply frequency	50/60 Hz
Permitted supply frequency range	48 to 63 Hz
Maximum power consumption	Approx. 280 VA

* This instrument can use a 100 V or a 200 V power supply. The maximum rated voltage differs according to the type of power cord. Check that the voltage supplied to the instrument is less than or equal to the maximum rated voltage of the power cord that you will be using before use.

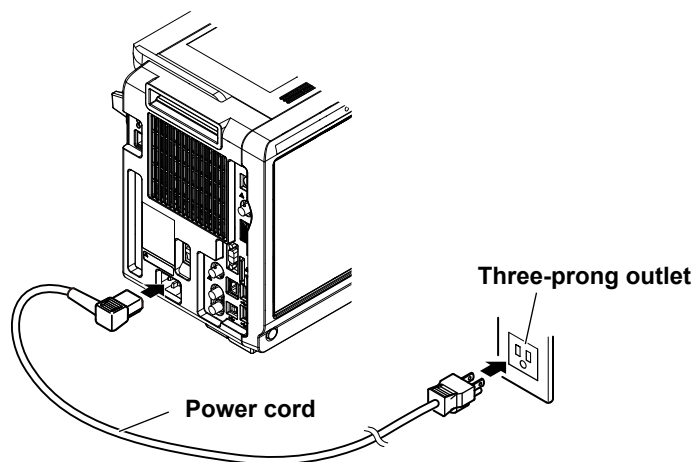

3.5 Turning the Power Switch On and Off

Turning On the Power Switch

Before Turning On the Power, Check That:

- The instrument is installed properly. See section 3.2, “Installing the Instrument”
- The power cord is connected properly. See page 3-15.

Turning On the Main Power Switch

1. Switch the power switch on the left side panel to the ON (|) position.
The front-panel power switch illuminates in orange.

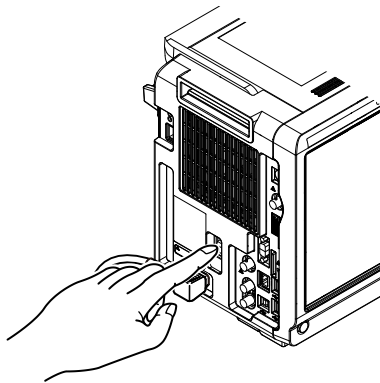

Turning On the Power Switch

2. Press the power switch on the front panel.
The power switch color will change from orange to green.

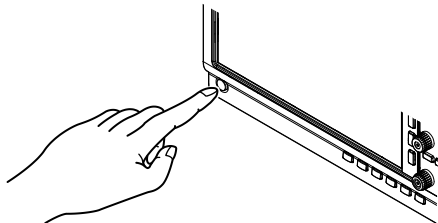

Note

If you set the startup mode (Startup Mode) to immediate startup (Immediate Startup), you can start the instrument by simply turning on the main power switch.

To display the startup mode setup menu, select the UTILITY menu > Preference (Preference) > Power On Action (Power On Action).

Operations Performed When the Power Is Turned On

When the power switch is turned on, a self-test and calibration start automatically. These take about 30 seconds, and the waveform display screen appears. Check that the instrument has started normally before you use it.

If the Instrument Does Not Start Normally When the Power Is Turned On

Turn off the power switch, and check the following items.

- Check that the power cord is securely connected.
- The correct voltage is coming to the power outlet. See page 3-15.
- Initialize the settings to their factory defaults by turning on the power switch while holding down the RESET key. For details about initializing the settings, see section 4.6, "Initializing Settings."

If the instrument still does not work properly after checking these items, contact your nearest YOKOGAWA dealer for repairs.

Note

- After turning the power off, wait at least 10 seconds before you turn it on again.
- It may take a few seconds for the startup screen to appear.

Turning Off the Power Switch

CAUTION

Turning off the power switch abruptly or unplugging the power cord while the instrument is saving data may corrupt the media on which data is being saved. Also, the data being saved is not guaranteed. Always turn the power switch off after data has been saved.

French

ATTENTION

Éteindre brutalement l'interrupteur d'alimentation ou le débranchement du câble d'alimentation pendant que l'instrument enregistre des données pourrait corrompre le média sur lequel les données sont enregistrées. De plus, les données enregistrées ne sont pas garanties. Les données en cours d'enregistrement pourront également être perdues. Toujours mettre l'instrument hors tension après que les données ont été enregistrées.

Turning Off the Power Switch

1. Press the power switch on the front panel.

Turning Off the Main Power Switch

2. Check that the front-panel power switch changes from green to orange, and then flip the power switch on the left side panel to the OFF (○) position.

Power-off Operation

The settings immediately before the power switch is turned off are stored. This means that if you turn the power switch on and begin measurement, the instrument will perform measurements using the settings from immediately before the instrument was last turned off.

Note

- When turning the power off, turn off the power switch on the front panel, and then turn off the main power switch on the left side panel.
 - If you turn off the main power switch on the left side panel while the power switch on the front panel is turned on, the setup data immediately before the power switch is turned off may not be stored properly. A message may appear the next time you start the instrument, but this is not a malfunction.
 - The instrument stores the settings using an internal lithium battery. The battery lasts for approximately five years when the ambient temperature is 23 °C. When the lithium battery voltage falls below a specified value and you turn on the power, a message (error 901) appears on the screen. If this message appears frequently, you need to replace the battery soon. You cannot replace batteries by yourself. Contact your nearest YOKOGAWA dealer to have the battery replaced.
-

To Make Accurate Measurements

- Allow the instrument to warm up for at least 30 minutes after turning on the power switch.
- After warm-up, calibrate the instrument (see section 4.9). If auto calibration is turned on, auto calibration is executed when you start waveform acquisition.

3.6 Connecting Probes

Connecting Probes

Connect the probes (or other input cables such as BNC cables) to any of the input terminals of the following modules. The input impedance is $1\text{ M}\Omega \pm 1\%$ and approximately 35 pF .

- High-Speed 200MS/s, 14bit Isolation Module: 720212 (HS200M14)
- High-Speed 100 MS/s, 12-Bit Isolation Module: 720211 (HS100M12)
- High-Speed 10 MS/s, 12-Bit Isolation Module: 701250 (HS10M12), 720250 (HS10M12)
- High-Speed High-Resolution 1 MS/s, 16-Bit Isolation Module: 701251 (HS1M16)
- High-Speed 10 MS/s, 12-Bit Non-Isolation Module: 701255 (NONISO_10M12)
- Acceleration/Voltage Module (with AAF): 701275 (ACCL/VOLT)
- Frequency Module: 701281 (FREQ), 720281 (FREQ)
- SENT Monitor Module: 720243 (SENT)
- 4-CH 10 MS/s, 16-Bit Isolation Module: 720256 (4CH 10M16)
- 4-CH 1 MS/s, 16-Bit Isolation Module: 720254 (4CH 1M16)

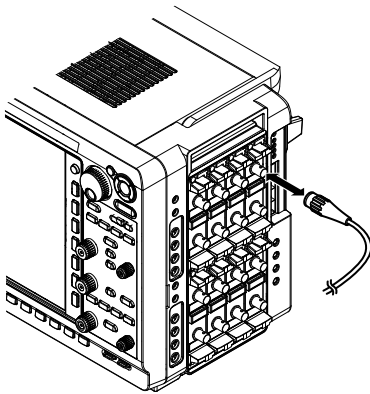

WARNING

When connecting a device under measurement to the instrument, be sure to turn off the device. It is extremely dangerous to connect or remove measurement leads while the device under measurement is on.

Precautions to Be Taken When Using the Modules

- Do not apply voltage exceeding the maximum input voltage or maximum rated voltage to ground.

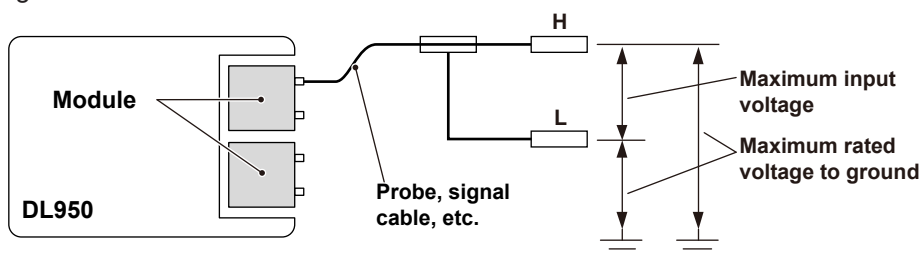

- To avoid electric shock, be sure to ground the instrument.
- To prevent the possibility of electric shock, be sure to fasten the module screws. Otherwise, the electrical and mechanical protection functions will not be activated.

3.6 Connecting Probes

- Avoid continuous connection in an environment where a surge voltage may occur.
- Use only specified cables. It is extremely dangerous to use cables that do not meet the safety standards. (Especially when you are handling high voltages of 42 V or more.)
- To measure high voltage with the 720212 (HS200M14), 720211 (HS100M12), 701250 (HS10M12), 720250 (HS10M12), 701251 (HS1M16), 720256 (4CH 10M16), or 720254 (4CH 1M16), use the isolated probes (700929, 701947), passive probes 702902, 1:1 safety cables (combination of 701901 and 701954), or differential probes (700924, 700925, 701926).
- The 10 MHz 701940 passive probe has metal BNC parts. If you want to use it for isolated input (e.g., 720212 (HS200M14), 720211 (HS100M12), 701250 (HS10M12), 720250 (HS10M12), 701251 (HS1M16), 701275 (ACCL/VOLT), 701281 (FREQ), 720281 (FREQ), 720256 (4CH 10M16), 720254 (4CH 1M16)), use it under 42 V for safety reasons. (Do not connect either the high or low side to an electric potential at 42 V or higher.) For non-isolated input (e.g., 701255 (NONISO_10M12)), fasten the module screws.
- To input high voltage with the 701281 (FREQ) or 720281 (FREQ), use an isolated probe (700929, 701947) or passive probe 702902.

In Using the High Voltage Differential Probes

- Be sure to connect the ground lead of the differential probe (700924, 700925, 701926) to the functional grounding terminal on the right side panel of the instrument. Not doing so may cause high voltage to appear in the BNC connector of the differential probe.
- The 701977 and 701978 differential probes can only be used on the 701255 (NONISO_10M12) Non-Isolation Module. Using them on an isolation module may cause high voltage to appear in the BNC connector of the differential probe.

Modules' Maximum Input Voltages and Maximum Rated Voltage to Ground

Applying a voltage exceeding the value indicated below may damage the input section. If the frequency is above 1 kHz, damage may occur even when the voltage is below this value. The maximum input voltage may vary depending on the actual input voltage. For details, see appendix 12.

720212 (HS200M14)

Maximum input voltage (at a frequency of 1 kHz or less)

- In combination with an isolated probe (10:1) 700929 or (100:1) 701947, or a passive probe (10:1) 702902¹
1000 V (DC+ACpeak) CAT II
- In combination with a safety cable (1:1) (701901+701954)³
200 V (DC+ACpeak) CAT II
- Direct input (cable that does not comply with the safety standards)⁵
42 V (DC+ACpeak)

Maximum rated voltage to ground (at a frequency of 1 kHz or less)

- In combination with an isolated probe (10:1) 700929 or (100:1) 701947, or a passive probe (10:1) 702902,² or a safety cable (1:1) (701901+701954)⁴
1000 Vrms (CAT II)
 - Direct input (cable that does not comply with the safety standards)⁶
42 V (DC+ACpeak)
-

720211 (HS100M12)

Maximum input voltage (at a frequency of 1 kHz or less)

- In combination with an isolated probe (10:1) 700929 or (100:1) 701947, or a passive probe (10:1) 702902¹
1000 V (DC+ACpeak) CAT II
- In combination with a safety cable (1:1) (701901+701954)³
200 V (DC+ACpeak)
- Direct input (cable that does not comply with the safety standards)⁵
42 V (DC+ACpeak)

Maximum rated voltage to ground (at a frequency of 1 kHz or less)

- In combination with an isolated probe (10:1) 700929 or (100:1) 701947,² or a safety cable (1:1) (701901+701954)⁴
1000 Vrms (CAT II)
- In combination with a passive probe (10:1) 702902²
1000 V (DC+ACpeak)
- Direct input (cable that does not comply with the safety standards)⁶
42 V (DC+ACpeak) (CAT II, 30 Vrms)

701250 (HS10M12) or 720250 (HS10M12)

Maximum input voltage (at a frequency of 1 kHz or less)

- In combination with an isolated probe (10:1) 700929 or (100:1) 701947, or a passive probe (10:1) 702902¹
701250: 600 V (DC+ACpeak)
720250: 800 V (DC+ACpeak)
- In combination with a safety cable (1:1) (701901+701954)³
200 V (DC+ACpeak) (as a value that meets the safety standard)
250 V (DC+ACpeak) (maximum allowable voltage, as a value that does not damage the instrument when applied)
- Direct input (cable that does not comply with the safety standards)⁵
42 V (DC+ACpeak)

Maximum rated voltage to ground (at a frequency of 1 kHz or less)

- In combination with an isolated probe (10:1) 700929 or (100:1) 701947, or a passive probe (10:1) 702902,² or a safety cable (1:1) (701901+701954)⁴
701250: 400 Vrms (measurement category Other (O) 1500 V transient overvoltage), 300 Vrms (CAT II)
720250: 400 Vrms (CAT II)
- Direct input (cable that does not comply with the safety standards)⁶
42 V (DC+ACpeak) (CAT II, 30 Vrms)

701251 (HS1M16)

Maximum input voltage (at a frequency of 1 kHz or less)

- In combination with an isolated probe (10:1) 700929 or (100:1) 701947, or a passive probe (10:1) 702902¹
600 V (DC+ACpeak)
- In combination with a safety cable (1:1) (701901+701954)³
140 V (DC+ACpeak)
- Direct input (cable that does not comply with the safety standards)⁵
42 V (DC+ACpeak)

Maximum rated voltage to ground (at a frequency of 1 kHz or less)

- In combination with an isolated probe (10:1) 700929 or (100:1) 701947, or a passive probe (10:1) 702902,² or a safety cable (1:1) (701901+701954)⁴
400 Vrms (measurement category Other (O) 1500 V transient overvoltage), 300 Vrms (CAT II)
- Direct input (cable that does not comply with the safety standards)⁶
42 V (DC+ACpeak) (CAT II, 30 Vrms)

3.6 Connecting Probes

701255 (NONISO_10M12)

This module is non-isolated. Be sure to fasten the module screws when measuring a voltage above 42 V on this module. In addition, use the 701940 (10:1) dedicated non-isolated passive probe.

Maximum input voltage (at a frequency of 1 kHz or less)

- In combination with a passive probe (10:1) 7019402
600 V (DC+ACpeak)
 - Direct input⁵
200 V (DC+ACpeak) (as a value that meets the safety standard)
250 V (DC+ACpeak) (maximum allowable voltage, as a value that does not damage the instrument when applied)
-

701275 (ACCL/VOLT)

Maximum input voltage (at a frequency of 1 kHz or less)

- Combined with the 701940 (10:1) passive probe⁷ or direct input (cable that does not comply with the safety standards)⁵
42 V (DC+ACpeak)

Maximum rated voltage to ground (at a frequency of 1 kHz or less)

- Combined with the 701940 (10:1) passive probe⁸ or direct input (cable that does not comply with the safety standards)⁶
42 V (DC+ACpeak) (CAT II, 30 Vrms)
-

701281 (FREQ) and 720281 (FREQ)

Maximum input voltage (at a frequency of 1 kHz or less)

- In combination with an isolated probe (10:1) 700929 or (100:1) 701947, or a passive probe (10:1) 702902¹
420 V (DC+ACpeak)
- Safety cable (1:1) (combined with 701901+701954)³ or direct input (cable that does not comply with the safety standards)⁵
42 V (DC+ACpeak)

Maximum rated voltage to ground (at a frequency of 1 kHz or less)

- In combination with an isolated probe (10:1) 700929 or (100:1) 701947, or a passive probe (10:1) 702902²
701281: 300 Vrms (CAT II)
720281: 400 Vrms (CAT II)
 - Safety cable (1:1) (701901+701954) passive probe⁴ or direct input (cable that does not comply with the safety standards)⁶
42 V (DC+ACpeak) (CAT II, 30 Vrms)
-

720243 (SENT)

Maximum input voltage (at a frequency of 1 kHz or less)

- In combination with an isolated probe (10:1) 700929 or a passive probe (10:1) 702902¹
420 V (DC+ACpeak)
- Safety cable (1:1) (combined with 701901+701954)³ or direct input (cable that does not comply with the safety standards)⁵
42 V (DC+ACpeak)

Maximum rated voltage to ground (at a frequency of 1 kHz or less)

- In combination with an isolated probe (10:1) 700929 or a passive probe (10:1) 702902²
300 Vrms (CAT II)
 - Safety cable (1:1) (701901+701954) passive probe⁴ or direct input (cable that does not comply with the safety standards)⁶
42 V (DC+ACpeak) (CAT II, 30 Vrms)
-

720256 (4CH 10M16)

Maximum input voltage (at a frequency of 1 kHz or less)

- In combination with an isolated probe (10:1) 700929 or (100:1) 701947, or a passive probe (10:1) 702902¹
600 V (DC+ACpeak)
- In combination with a safety cable (1:1) (701901+701954)³
200 V (DC+ACpeak)
- Direct input (cable that does not comply with the safety standards)⁵
42 V (DC+ACpeak)

Maximum rated voltage to ground (at a frequency of 1 kHz or less)

- In combination with an isolated probe (10:1) 700929 or (100:1) 701947, or a passive probe (10:1) 702902,² or a safety cable (1:1) (701901+701954)⁴
400 Vrms (measurement category Other (O) 1500 V transient overvoltage), 300 Vrms (CAT II)
- Direct input (cable that does not comply with the safety standards)⁶
42 V (DC+ACpeak) (CAT II, 30 Vrms)

720254 (4CH 1M16)

Maximum input voltage (at a frequency of 1 kHz or less)

- In combination with an isolated probe (10:1) 700929 or (100:1) 701947, or a passive probe (10:1) 702902¹
600 V (DC+ACpeak)
- In combination with a safety cable (1:1) (701901+701954)³
200 V (DC+ACpeak) (as a value that meets the safety standard)
400 V (DC+ACpeak) (maximum allowable voltage, as a value that does not damage the instrument when applied)
- Direct input (cable that does not comply with the safety standards)⁵
42 V (DC+ACpeak)

Maximum rated voltage to ground (at a frequency of 1 kHz or less)

- In combination with an isolated probe (10:1) 700929 or (100:1) 701947, or a passive probe (10:1) 702902,² or a safety cable (1:1) (701901+701954)⁴
400 Vrms (measurement category Other (O) 1500 V transient overvoltage), 300 Vrms (CAT II)
- Direct input (cable that does not comply with the safety standards)⁶
42 V (DC+ACpeak) (CAT II, 30 Vrms)

With the 700929, 701947, or 702902

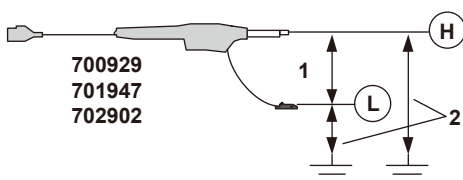

With the 701901 and 701954

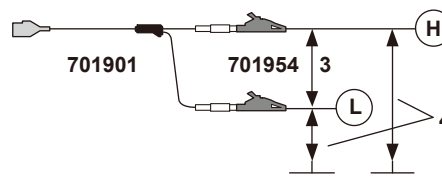

Direct input (cable that does not comply with the safety standards)

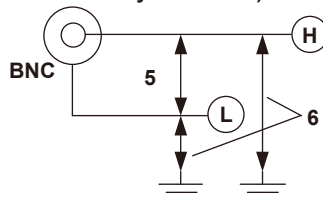

With the 10:1 passive probe (701940)

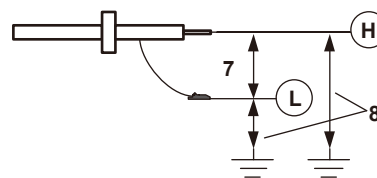

Over-Range Indication

If over-range is indicated, the instrument may be receiving a voltage higher than the observed waveform or measured waveform values. To prevent electric shock, change the vertical scale with the SCALE knob so that the entire amplitude of the waveform is displayed within the waveform display area, and check the input voltage level.



Over-range indication

Indicates the number of the channel that over-range is occurring on. If over-range is occurring on multiple channels, the smallest channel number among them is indicated as follows: **CH3**.

French



AVERTISSEMENT

Lors de la connexion à l'instrument d'un appareil faisant l'objet de la mesure, éteindre impérativement l'appareil. Il est extrêmement dangereux de brancher un câble de mesure lorsque l'appareil à mesurer est sous tension.

Précautions à prendre lors de l'utilisation des modules

- Ne pas appliquer une tension dépassant la tension d'entrée maximum ou la tension nominale à la terre maximum.

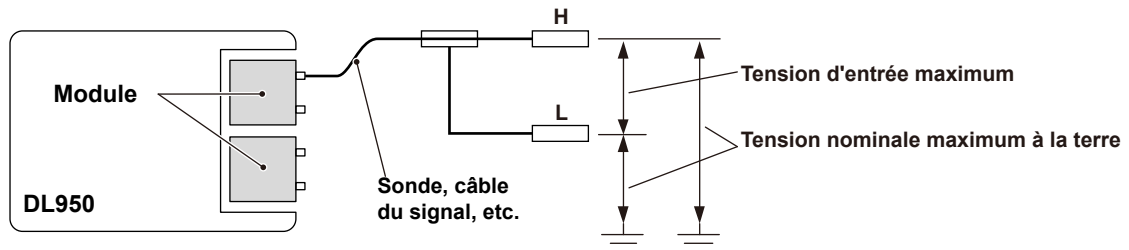

- Pour éviter tout risque de choc électrique, l'instrument doit impérativement être relié à la terre.
- Pour éviter tout risque de choc électrique, toujours serrer les vis des modules, à défaut de quoi les fonctions de protection électrique et de protection mécanique ne seront pas activées.
- Évitez un branchement continu dans un environnement pouvant être soumis à une surtension.
- Utilisez uniquement les câbles préconisés. Il est extrêmement dangereux d'utiliser des câbles n'étant pas conformes aux normes de sécurité. (notamment lorsque vous travaillez avec de hautes tensions de 42 V, voire supérieures).
- Pour mesurer la haute tension avec le 720212 (HS200M14), 720211 (HS100M12), 701250 (HS10M12), 720250 (HS10M12), 701251 (HS1M16), 720256 (4CH 10M16) ou 720254 (4CH 1M16), utiliser les sondes isolées (700929, 701947), sondes passives 702902, câbles de sécurité 1: 1 (combinaison de 701901 et 701954) ou sondes différentielles (700924, 700925, 701926).

- La sonde passive 10 MHz 701940 comporte des pièces BNC métalliques. Si vous souhaitez l'utiliser pour une entrée isolée (par exemple, 720212 (HS200M14), 720211 (HS100M12), 701250 (HS10M12), 720250 (HS10M12), 701251 (HS1M16), 701275 (ACCL / VOLT), 701281 (FREQ), 720281 (FREQ), 720256 (4CH 10M16), 720254 (4CH 1M16)), utilisez-le sous 42 V pour la sécurité. (Ne connectez ni le côté haut ni le côté bas à un potentiel électrique de 42 V ou plus.) Pour une entrée non-isolée (par exemple, 701255 (NONISO_10M12)), serrez les vis du module.
- Pour entrer la tension élevée avec 701281 (FREQ) ou 720281(FREQ), utiliser une sonde isolée (700929, 701947) ou une sonde passive 702902.

Utilisation de sondes différentielles haute tension

- Veiller à connecter le fil de terre de la sonde différentielle (700924, 700925, 701926) à la borne de mise à la terre fonctionnelle sur le panneau latéral droit de l'instrument. Sinon, une haute tension pourrait causer dans le connecteur BNC de la sonde différentielle. Le fait de ne pas respecter cette consigne risque d'entraîner l'apparition d'une tension élevée au niveau du connecteur BNC de la sonde différentielle.
- Les sondes différentielles 701977 et 701978 ne peuvent être utilisées que sur le module non-isolation 701255 (NONISO_10M12). Leur utilisation sur un module d'isolation pourrait causer l'apparition d'une haute tension dans le connecteur BNC de la sonde différentielle.

Tension d'entrée maximum et tension nominale à la terre maximum pour les modules

L'application d'une tension supérieure à la valeur indiquée ci-dessous pourrait endommager la section d'entrée. Si la fréquence est supérieure à 1 kHz, des dommages risquent de survenir même lorsque la tension est inférieure à cette valeur. La tension d'entrée maximale pourrait varier selon la tension d'entrée réelle. Pour plus de détails, voir l'appendice 12.

720212 (HS200M14)

Tension d'entrée maximale (à une fréquence de 1 kHz ou moins)

- En combinaison avec une sonde isolée (10:1) 700929 ou (100:1) 701947, ou une sonde passive (10:1) 702902¹
1000 V (DC+ACpeak) CAT II
- En combinaison avec un câble de sécurité (1:1) (701901 + 701954)³
200 V (DC+ACpeak) CAT II
- Entrée directe (câble qui non conforme aux normes de sécurité)⁵
42 V (DC+ACpeak)

Tension nominale à la terre maximum (à une fréquence de 1 kHz ou moins)

- En combinaison avec une sonde isolée (10:1) 700929 ou (100:1) 701947 ou une sonde passive (10:1) 702902.² Ou si utilisé avec le câble de sécurité (1:1; 701901 et 701954 conjointement).⁴
1000 Vrms (CAT II)
- Entrée directe (câble qui non conforme aux normes de sécurité)⁶
42 V (DC+ACpeak)

720211 (HS100M12)

Tension d'entrée maximale (à une fréquence de 1 kHz ou moins)

- En combinaison avec une sonde isolée (10:1) 700929 ou (100:1) 701947, ou une sonde passive (10:1) 702902¹
1000 V (DC+ACpeak) CAT II
- En combinaison avec un câble de sécurité (1:1) (701901 + 701954)³
200 V (DC+ACpeak)
- Entrée directe (câble qui non conforme aux normes de sécurité)⁵
42 V (DC+ACpeak)

3.6 Connecting Probes

Tension nominale à la terre maximum (à une fréquence de 1 kHz ou moins)

- En combinaison avec une sonde isolée (10:1) 700929 ou (100:1) 701947,² ou un câble de sécurité (1:1) (701901 + 701954)⁴
1000 Vrms (CAT II)
- En combinaison avec une sonde passive (1:1) (702902 + 701954)²
1000 V (DC+ACpeak) CAT II
- Entrée directe (câble qui non conforme aux normes de sécurité)⁶
42 V (DC+ACpeak) (CAT II, 30 Vrms)

701250 (HS10M12) ou 720250 (HS10M12)

Tension d'entrée maximale (à une fréquence de 1 kHz ou moins)

- En combinaison avec une sonde isolée (10:1) 700929 ou (100:1) 701947 ou une sonde passive (10:1) 701250¹
701250: 600 V (c.c. + crête c.a.)
720250: 800 V (c.c. + crête c.a.)
- En combinaison avec un câble de sécurité (1:1) (701901 + 701954)³
200 V (c.c. + crête c.a.) (comme valeur conforme à la norme de sécurité).
250 V (c.c. + crête c.a.) (tension maximale admise, comme valeur qui n'endommage pas l'instrument lorsqu'elle est appliquée).
- Entrée directe (câble qui non conforme aux normes de sécurité)⁵
42 V (DC+ACpeak)

Tension nominale à la terre maximum (à une fréquence de 1 kHz ou moins)

- En combinaison avec une sonde isolée (10:1) 700929 ou (100:1) 701947 ou une sonde passive (10:1) 702902.² Ou si utilisé avec le câble de sécurité (1:1; 701901 et 701954 conjointement).⁴
701250: 400 Vrms (catégorie de mesure Autre (O) surtension transitoire 1500 V), 300 Vrms (CAT II)
720250: 400 Vrms (CAT II)
- Entrée directe (câble qui non conforme aux normes de sécurité)⁶
42 V (DC+ACpeak) (CAT II, 30 Vrms)

701251 (HS1M16)

Tension d'entrée maximale (à une fréquence de 1 kHz ou moins)

- En combinaison avec une sonde isolée (10:1) 700929 ou (100:1) 701947, ou une sonde passive (10:1) 702902¹
600 V (DC+ACpeak)
- En combinaison avec un câble de sécurité (1:1) (701901 + 701954)³
140 V (DC+ACpeak)
- Entrée directe (câble qui non conforme aux normes de sécurité)⁵
42 V (DC+ACpeak)

Tension nominale à la terre maximum (à une fréquence de 1 kHz ou moins)

- En combinaison avec une sonde isolée (10:1) 700929 ou (100:1) 701947 ou une sonde passive (10:1) 702902.² Ou si utilisé avec le câble de sécurité (1:1; 701901 et 701954 conjointement).⁴
400 Vrms (catégorie de mesure Autre (O) surtension transitoire 1500 V), 300 Vrms (CAT II)
- Entrée directe (câble qui non conforme aux normes de sécurité)⁶
42 V (DC+ACpeak) (CAT II, 30 Vrms)

701255 (NONISO_10M12)

Ce module n'est pas isolé. Veuillez à serrer les vis du module lors de la mesure d'une tension supérieure à 42 V sur ce module. En outre, utilisez la sonde passive isolée et non isolée 701940 (10:1).

Tension d'entrée maximale (à une fréquence de 1 kHz ou moins)

- En combinaison avec une sonde passive (10:1) 701940
600 V (DC+ACpeak)
 - Entrée directe⁵
200 V (c.c. + crête c.a.) (comme valeur conforme à la norme de sécurité).
250 V (c.c. + crête c.a.) (tension maximale admise, comme valeur qui n'endommage pas l'instrument lorsqu'elle est appliquée).
-

701275 (ACCL/VOLT)

Tension d'entrée maximale (à une fréquence de 1 kHz ou moins)

- Associé à la sonde passive 701940 (10:1)⁷ ou à l'entrée directe (câble non conforme aux normes de sécurité)⁵
42 V (DC+ACpeak)

Tension nominale à la terre maximum (à une fréquence de 1 kHz ou moins)

- Associé à la sonde passive 701940 (10:1)⁸ ou à l'entrée directe (câble non conforme aux normes de sécurité)⁶
42 V (DC+ACpeak) (CAT II, 30 Vrms)

701281 (FREQ) et 720281 (FREQ)

Tension d'entrée maximale (à une fréquence de 1 kHz ou moins)

- En combinaison avec une sonde isolée (10:1) 700929 ou (100:1) 701947, ou une sonde passive (10:1) 702902¹
420 V (DC+ACpeak)
- Câble de sécurité (1:1) (associé à 701901 + 701954)³ ou entrée directe (câble non conforme aux normes de sécurité)⁵
42 V (DC+ACpeak)

Tension nominale à la terre maximum (à une fréquence de 1 kHz ou moins)

- En combinaison avec une sonde isolée (10:1) 700929 ou (100:1) 701947 ou une sonde passive (10:1) 701281²
701250: 300 Vrms (CAT II)
720281: 400 Vrms (CAT II)
- En combinaison avec un câble de sécurité (1: 1) (701901 + 701954)⁴ ou à l'entrée directe (câble non conforme aux normes de sécurité)⁶
42 V (DC+ACpeak) (CAT II, 30 Vrms)

720243 (SENT)

Tension d'entrée maximale (à une fréquence de 1 kHz ou moins)

- En combinaison avec une sonde isolée (10:1) 700929 ou une sonde passive (10:1) 702902¹
420 V (DC+ACpeak)
- Câble de sécurité (1:1) (associé à 701901 + 701954)³ ou entrée directe (câble non conforme aux normes de sécurité)⁵
42 V (DC+ACpeak)

Tension nominale à la terre maximum (à une fréquence de 1 kHz ou moins)

- En combinaison avec une sonde isolée (10:1) 700929 ou une sonde passive (10:1) 702902²
300 Vrms (CAT II)
- En combinaison avec un câble de sécurité (1: 1) (701901 + 701954)⁴ ou à l'entrée directe (câble non conforme aux normes de sécurité)⁶
42 V (DC+ACpeak) (CAT II, 30 Vrms)

720256 (4CH 10M16)

Tension d'entrée maximale (à une fréquence de 1 kHz ou moins)

- En combinaison avec une sonde isolée (10:1) 700929 ou (100:1) 701947, ou une sonde passive (10:1) 702902¹
600 V (DC+ACpeak)
- En combinaison avec un câble de sécurité (1:1) (701901 + 701954)³
200 V (DC+ACpeak)
- Entrée directe (câble qui non conforme aux normes de sécurité)⁵
42 V (DC+ACpeak)

Tension nominale à la terre maximum (à une fréquence de 1 kHz ou moins)

- En combinaison avec une sonde isolée (10:1) 700929 ou (100:1) 701947 ou une sonde passive (10:1) 702902.² Ou si utilisé avec le câble de sécurité (1:1; 701901 et 701954 conjointement).⁴
400 Vrms (catégorie de mesure Autre (O) surtension transitoire 1500 V), 300 Vrms (CAT II)
- Entrée directe (câble qui non conforme aux normes de sécurité)⁶
42 V (DC+ACpeak) (CAT II, 30 Vrms)

3.6 Connecting Probes

720254 (4CH 1M16)

Tension d'entrée maximale (à une fréquence de 1 kHz ou moins)

- En combinaison avec une sonde isolée (10:1) 700929 ou (100:1) 701947, ou une sonde passive (10:1) 702902¹
600 V (DC+ACpeak)
- En combinaison avec un câble de sécurité (1:1) (701901 + 701954)³
200 V (c.c. + crête c.a.) (comme valeur conforme à la norme de sécurité).
400 V (c.c. + crête c.a.) (tension maximale admise, comme valeur qui n'endommage pas l'instrument lorsqu'elle est appliquée).
- Entrée directe (câble qui non conforme aux normes de sécurité)⁵
42 V (DC+ACpeak)

Tension nominale à la terre maximum (à une fréquence de 1 kHz ou moins)

- En combinaison avec une sonde isolée (10:1) 700929 ou (100:1) 701947 ou une sonde passive (10:1) 702902.² Ou si utilisé avec le câble de sécurité (1:1; 701901 et 701954 conjointement).⁴
400 Vrms (catégorie de mesure Autre (O) surtension transitoire 1500 V), 300 Vrms (CAT II)
- Entrée directe (câble qui non conforme aux normes de sécurité)⁶
42 V (DC+ACpeak) (CAT II, 30 Vrms)

Avec 700929, 701947 ou 702902

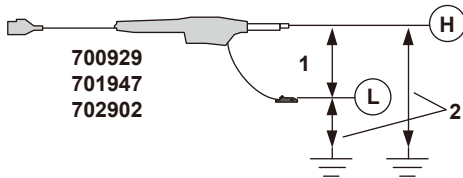

Avec 701901 et 701954

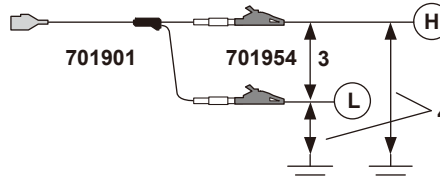

Entrée directe (câble non conforme aux normes de sécurité)

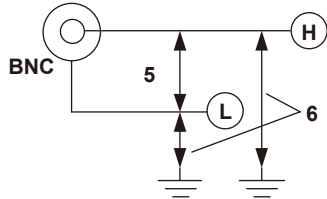

Avec la sonde passive 10:1 (701940)

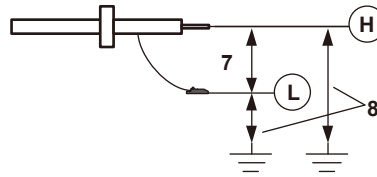

Dépassement de plage

En cas de dépassement de plage, l'instrument risque de recevoir une tension supérieure à la forme d'onde observée ou aux valeurs de forme d'onde mesurées. Pour éviter tout risque de choc électrique, modifier l'échelle de gain vertical à l'aide du bouton SCALE, de sorte que l'amplitude entière de la forme d'onde s'affiche sur l'afficheur, et vérifier le niveau de tension d'entrée.



Dépassement de plage

Indique le numéro de canal sur lequel le dépassement de plage a lieu. Si un dépassement de plage se produit sur plusieurs canaux, le plus petit numéro de canal parmi eux est indiqué comme suit: **CH3**.

Precautions to Be Taken When Connecting Probes

- When connecting a probe to the instrument for the first time, perform phase correction of the probe as described in section 3.7, “Correcting a Probe Phase.” Make the phase correction on each channel to which the probe is to be connected.
- You cannot perform phase correction of the probe on the frequency module (701281 (FREQ) or 720281 (FREQ)) or SENT monitor module (720243 (SENT)). When connecting a probe to the 701281 (FREQ), 720281 (FREQ), or 720243 (SENT), first perform phase correction on the probe using another module.
- Please note that if the circuit being measured is directly connected to the instrument without the use of a probe, correct measurements may not be possible because of the effect of the input impedance of the instrument.
- Note that if you use a voltage probe other than an isolated probe (700929 or 701947) or passive probe (702902), correct measurements cannot be displayed when the attenuation is not 1:1, 10:1, 100:1, or 1000:1.
- Follow the instructions given in section 1.1, “Configuring Voltage Measurements,” in the user’s manual to set the probe attenuation or the current-to-voltage conversion ratio to match the actual value using the setup menu. If they do not match, measured values cannot be read correctly.

Connecting Current Probes

When using current probes made by YOKOGAWA,* use the probe power supply terminals (optional) on the right side panel of the instrument.

* YOKOGAWA current probes: 701930, 701931, 701932, 701933, 701917, 701918, 702915, 702916

For details on the connection procedure, see the manual that came with the current probe.

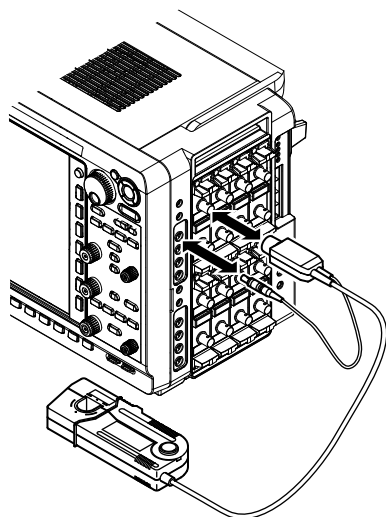

CAUTION

Do not use the probe power supply terminals (/P4, /P8 option) on the right side panel of the instrument for purposes other than supplying power to the probes.

French



ATTENTION

Ne pas utiliser les bornes d'alimentation de la sonde (/P4, /P8 option) sur le panneau latéral droit de l'instrument à d'autres fins que l'alimentation des sondes.

Specifications of the Probe Power Supply Terminals (/P4, P8 option)

Item	
Number of probes that can be used	4 (/P4 option), 8 (/P8 option)
Probes that can be used	Current probe (701917, 701918, 701930, 701931, 701932, 701933, 702915, 702916) Differential probe (701977, 701978)
Output voltage	±12 V
Output current	<ul style="list-style-type: none"> • 4 outputs (/P4 option): Total current up to 2.4 A • 8 outputs (/P8 option): Total current up to 4.8 A*

* There are two sets (top and bottom) of probe power supply terminals on the right side panel. Each set consists of four outputs. The maximum output current per set is 2.4 A.

Notes When Connecting 701917, 701918, 702915, or 702916 Current Probes

The following limitations apply when connecting 701917, 701918, 702915, and 702916 current probes to modules due to the structure of the terminators.

- It is not possible to connect two of these current probes to channels at the same positions of modules installed in adjacent slots.
- When using a 4-CH module, other BNC connectors cannot be connected to channels that are vertically adjacent to channels that these current probes are connected to.

Possible

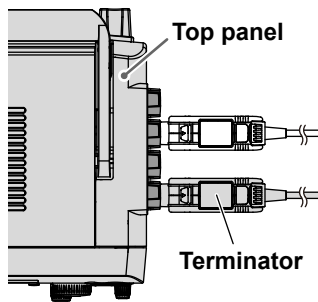

Not possible

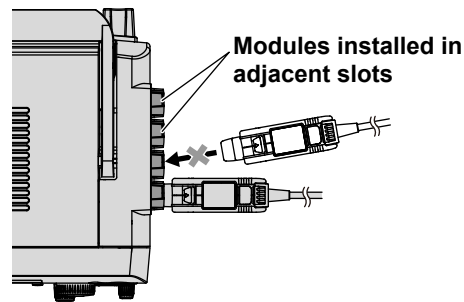

4-CH module Possible

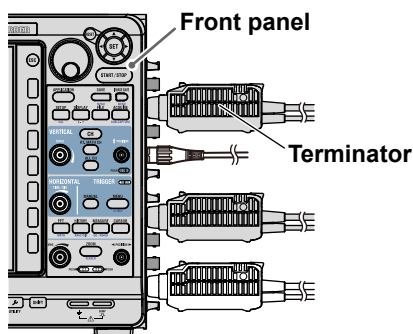

Not possible

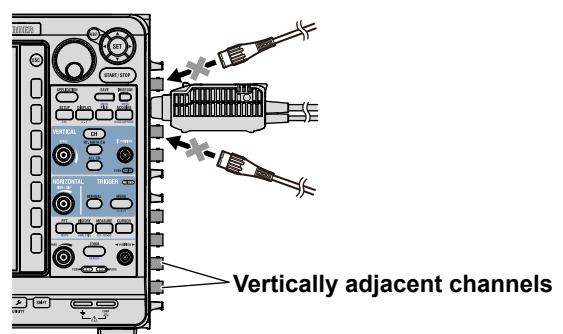

Connecting Differential Probes

When using Yokogawa differential probes (700924, 700925, 701926), connect the GND lead to the instrument's functional ground terminal. If necessary, use the auxiliary grounding lead extension.

When using YOKOGAWA differential probes (701977, 701978), use the probe power supply terminals (optional) on the right side panel of the instrument. For the specifications of the probe power supply terminal (option), see the previous page.

For details on the connection procedure, see the manual that came with the differential probe.

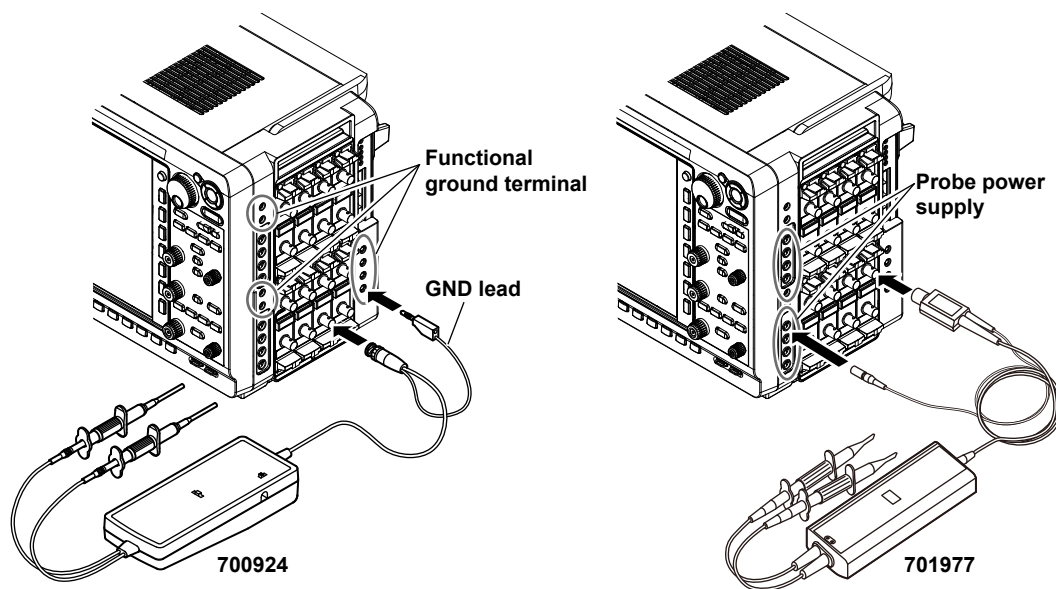

WARNING

In Using the High Voltage Differential Probes

- Be sure to connect the ground lead of the differential probe (700924, 700925, 701926) to the functional grounding terminal on the right side panel of the instrument before connecting to the measurement target. Not doing so may cause high voltage to appear in the BNC connector of the differential probe.
- The 701977 and 701978 differential probes can only be used on the 701255 (NONISO_10M12) Non-Isolation Module. Using them on an isolation module may cause high voltage to appear in the BNC connector of the differential probe.



CAUTION

Do not use the probe power supply terminals (/P4, /P8 option) on the right side panel of the instrument for purposes other than supplying power to the probes.

French



AVERTISSEMENT

Utilisation de sondes différentielles haute tension

- Veiller à connecter le fil de terre de la sonde différentielle (700924, 700925, 701926) à la borne de mise à la terre fonctionnelle sur le panneau latéral droit de l'instrument avant de le connecter à la cible de mesure. Sinon, une haute tension pourrait causer dans le connecteur BNC de la sonde différentielle. Le fait de ne pas respecter cette consigne risque d'entraîner l'apparition d'une tension élevée au niveau du connecteur BNC de la sonde différentielle.
- Les sondes différentielles 701977 et 701978 ne peuvent être utilisées que sur le module non-isolation 701255 (NONISO_10M12). Leur utilisation sur un module d'isolation pourrait causer l'apparition d'une haute tension dans le connecteur BNC de la sonde différentielle.



ATTENTION

Ne pas utiliser les bornes d'alimentation de la sonde (/P4, /P8 option) sur le panneau latéral droit de l'instrument à d'autres fins que l'alimentation des sondes.

3.7 Correcting the Probe Phase

For the following modules, always correct the probe phase before you use a probe for measurement.

- High-Speed 200MS/s, 14bit Isolation Module: 720212 (HS200M14)
- High-Speed 100 MS/s, 12-Bit Isolation Module: 720211 (HS100M12)
- High-Speed 10 MS/s, 12-Bit Isolation Module: 701250 (HS10M12), 720250 (HS10M12)
- High-Speed High-Resolution 1 MS/s, 16-Bit Isolation Module: 701251 (HS1M16)
- High-Speed 10 MS/s, 12-Bit Non-Isolation Module: 701255 (NONISO_10M12)
- Acceleration/Voltage Module (with AAF): 701275 (ACCL/VOLT)
- Frequency Module: 701281 (FREQ), 720281 (FREQ)
- SENT Monitor Module: 720243 (SENT)
- 4-CH 10 MS/s, 16-Bit Isolation Module: 720256 (4CH 10M16)
- 4-CH 1 MS/s, 16-Bit Isolation Module: 720254 (4CH 1M16)



CAUTION

Do not apply external voltage to the probe compensation signal output terminal. This may cause damage to the internal circuitry.

French



ATTENTION

Ne pas appliquer de tension externe sur la borne de sortie de signal afin d'ajuster la compensation de sonde. Cela pourrait endommager le circuit interne.

3.7 Correcting the Probe Phase

1. Turn on the power switch.
2. Connect the probe to a signal input terminal (the terminal that you will actually apply the signal to measure to).
3. Connect the tip of the probe to the probe compensation signal output terminal on the front panel of the instrument, and connect the ground wire to the functional ground terminal.
4. Follow the instructions in section 4.8, "Performing Auto Setup," to perform auto setup on the probe.
5. Insert a screwdriver into the phase adjustment hole, and turn the variable capacitor so that the displayed waveform is an appropriate square wave.

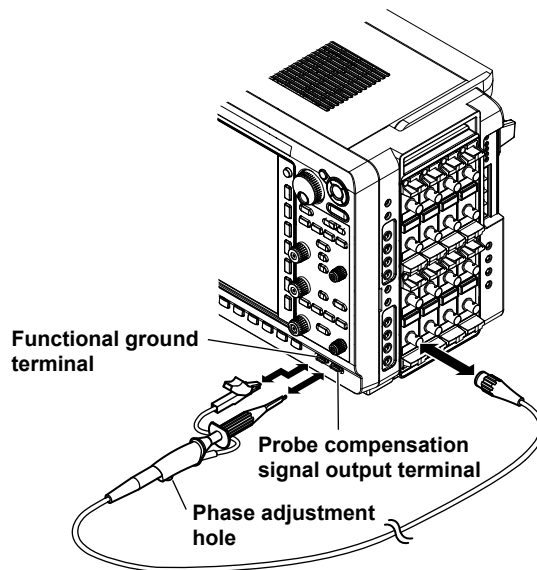

Necessity of Probe Phase Correction

If the probe's input capacitance is not within the appropriate range, the gain will not be steady in relation to the frequency, and waveforms will not be displayed correctly. Also, because the input capacitance is not the same for each probe, the probe's have variable capacitors (trimmers) that need to be adjusted. This adjustment is referred to as phase correction.

Always correct the phase of a probe that you are using for the first time.

Also, because the matching input capacitance range is different for each channel, you need to perform phase correction when you change the channel that a probe is connected to.

Phase Compensation Signal

The instrument generates the following square wave signal from the COMP signal output terminal.

Frequency: 1 kHz \pm 1 %

Amplitude: 1 V \pm 10 %

Differences in the Waveform due to the Phase Correction of the Probe

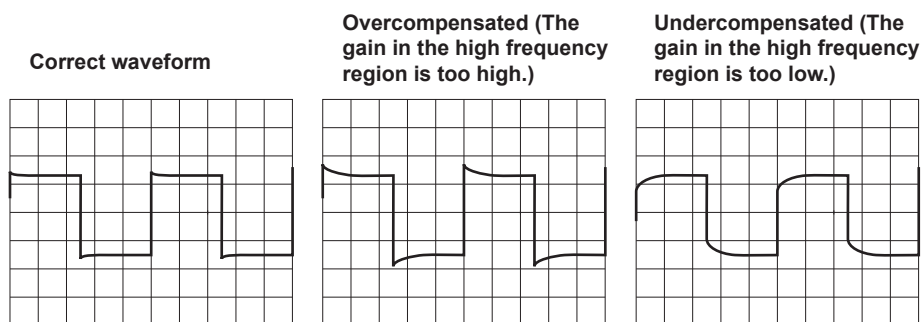

Notes about Using Probes with the Frequency Module or SENT Monitor Module

You cannot perform phase correction on a probe connected to the frequency module and SENT monitor module. To use a probe with the frequency module or SENT monitor module, first perform phase correction on the probe using another module.

3.8 Connecting Measurement Leads

Connecting Measurement Leads

When you measure voltage using the 701261 (UNIVERSAL), 701262 (UNIVERSAL (AAF)), 720268 (HV (AAF, RMS)), 701265 (TEMP/HPV), or 720266 (TEMP/HPV), connect the measurement leads of a plug-in type terminal to the input terminal.

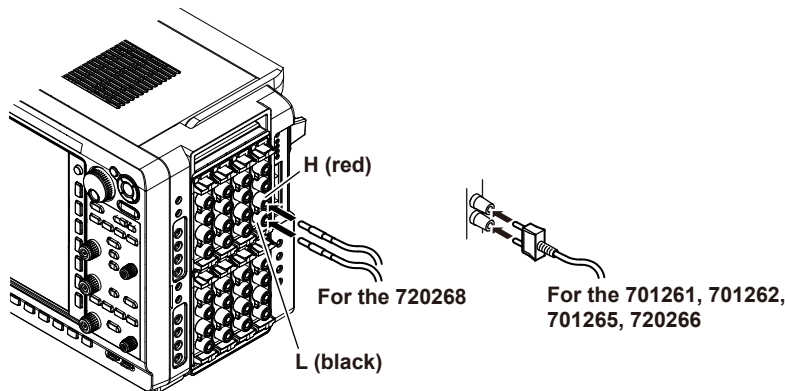

WARNING

- When connecting a device under measurement to the instrument, be sure to turn off the device. It is extremely dangerous to connect or remove measurement leads while the device under measurement is on.
- When measuring high voltages, do not connect a plug-in type terminal with exposed conducting parts to the input terminal to be used as a measurement lead. It is very dangerous, if the connector comes loose.

Precautions to Be Taken When Using the Modules

- To prevent the possibility of electric shock, always connect measurement leads that match the voltage range that you are measuring to the signal input terminals of the 701261 (UNIVERSAL), 701262 (UNIVERSAL (AAF)), 720268 (HV (with RMS)), 701265 (TEMP/HPV), or 720266 (TEMP/HPV).
- When measuring high voltages using the 720268 (HV (with RMS)), use a measurement lead 758933 or a 1:1 safety adapter lead 701904 and alligator clip 701954.

Modules' Maximum Input Voltages and Maximum Rated Voltage to Ground

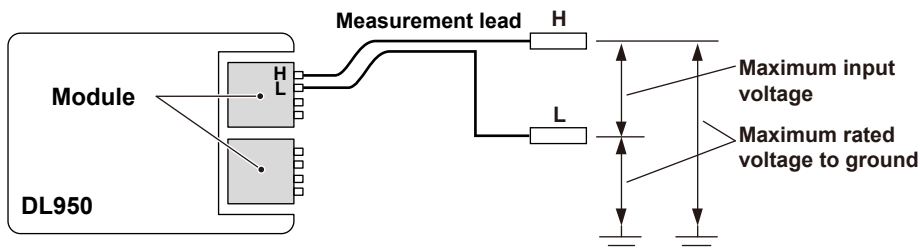

Applying a voltage exceeding the value indicated below may damage the input section. If the frequency is above 1 kHz, damage may occur even when the voltage is below this value. The maximum input voltage may vary depending on the actual input voltage. For details, see appendix 12.

701261, 701262, 701265, 720266

Maximum input voltage (across the input terminals, H and L,¹ at a frequency of 1 kHz or less)
42 V (DC+ACpeak)

Maximum rated voltage to ground (across the input terminals, H or L, and earth,² at a frequency of 1 kHz or less)

42 V (DC+ACpeak) (CAT II, 30 Vrms)

720268 (HV (AAF, RMS))

Maximum input voltage (at a frequency of 1 kHz or less)

- Combination of 758933 measurement leads and 701954 alligator clips or combination of 701904 1:1 safety cables and 701954 alligator clips³
1000 Vrms (1000 VDC or 1414 Vpeak MAX)
- Direct input (cable that does not comply with the safety standards)⁶
42 V (DC+ACpeak)

Maximum rated voltage to ground (at a frequency of 1 kHz or less)

- Combination of 758933 measurement leads and 701954 alligator clips or combination of 701904 1:1 safety cables and 701954 alligator clips⁵
1000 Vrms (CAT II)^{4, 5}, 600 Vrms (CAT III)^{4, 5}
- Direct input (cable that does not comply with the safety standards)⁷
42 V (DC+ACpeak) (CAT II, 30 Vrms)

For the 701261, 701262, 701265, or 720266

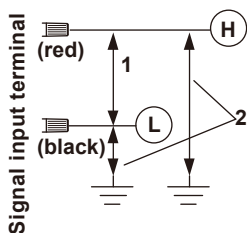

For the 720268

With the 758933+701954 or 701904+701954

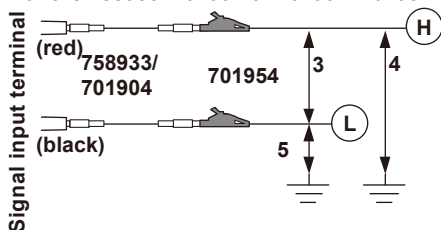

Direct input (cable that does not comply with the safety standards)

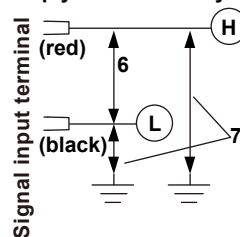

Over-Range Indication

If over-range is indicated, the instrument may be receiving a voltage higher than the observed waveform or measured waveform values. To prevent electric shock, change the vertical scale with the SCALE knob so that the entire amplitude of the waveform is displayed within the waveform display area, and check the input voltage level.



Over-range indication

Indicates the number of the channel that over-range is occurring on. If over-range is occurring on multiple channels, the smallest channel number among them is indicated as follows: CH3.

French



AVERTISSEMENT

- Lors de la connexion à l'instrument d'un appareil faisant l'objet de la mesure, éteindre impérativement l'appareil. Il est extrêmement dangereux de brancher un câble de mesure lorsque l'appareil à mesurer est sous tension.
- Lors de la mesure de tensions élevées, ne pas relier une borne de type enfichable, avec des parties conductrices exposées, à la borne d'entrée à utiliser comme un fil de mesure. Il est très dangereux que le connecteur se détache.

Précautions à prendre lors de l'utilisation des modules

- Pour éviter la possibilité de choc électrique, connecter toujours les cordons de mesure correspondants à la plage de tension que vous mesurez aux bornes d'entrée de signal du 701261 (UNIVERSAL), 701262 (UNIVERSAL (AAF)), 720268 (HV (with RMS)), 701265 (TEMP/HPV) ou 720266 (TEMP/HPV).
- Lors de la mesure de hautes tensions avec le 720268 (HV (with RMS)), utiliser un cordon de mesure 758933 ou un cordon adaptateur de sécurité 1: 1 701904 et une pince crocodile 701954.

Tension d'entrée maximum et tension nominale à la terre maximum pour les modules

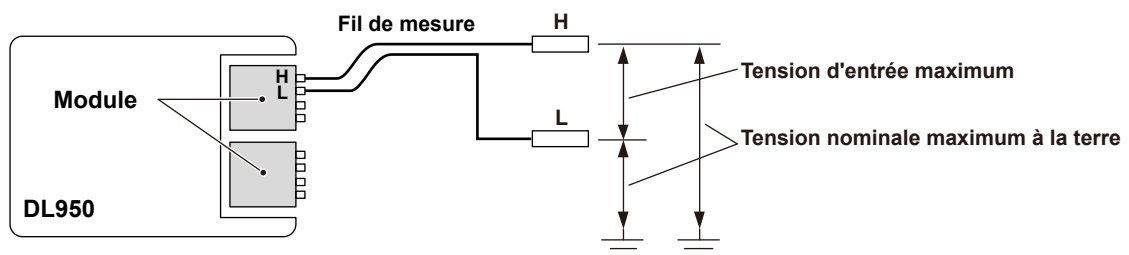

L'application d'une tension supérieure à la valeur indiquée ci-dessous pourrait endommager la section d'entrée. Si la fréquence est supérieure à 1 kHz, des dommages risquent de survenir même lorsque la tension est inférieure à cette valeur. La tension d'entrée maximale pourrait varier selon la tension d'entrée réelle. Pour plus de détails, voir l'appendice 12.

701261, 701262, 701265, 720266

Tension d'entrée maximale (via les bornes d'entrée, H et L,¹ à une fréquence d'1 kHz ou moins)
42 V (c.c. + crête c.a.)

Tension nominale à la terre maximum (via les bornes d'entrée, H ou L, et la terre,² à une fréquence de 1 kHz ou moins)

42 V (c.c. + crête c.a.) (CAT II 30 Vrms)

720268 (HV (AAF, RMS))

Tension d'entrée maximale (à une fréquence de 1 kHz ou moins)

- Combinaison de fils de mesure 758933 et de pinces alligator 701954 ou combinaison de câble de sécurité 1:1 701904 et de pinces alligator 701954.³
1000 Vrms (1000 VDC or 1414 Vpeak MAX)
- Entrée directe (câble qui non conforme aux normes de sécurité)⁶
42 V (DC+ACpeak)

Tension nominale à la terre maximum (à une fréquence de 1 kHz ou moins)

- Combinaison de fils de mesure 758933 et de pinces alligator 701954 ou combinaison de câble de sécurité 1:1 701904 et de pinces alligator 701954.⁵
1000 Vrms (CAT II),^{4,5} 600 Vrms (CAT III)^{4,5}
- Entrée directe (câble qui non conforme aux normes de sécurité)⁷
42 V (DC+ACpeak) (CAT II, 30 Vrms)

Pour 701261, 701262, 701265 et 720266

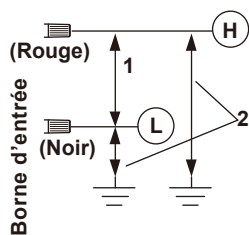

Pour 701268
Avec 758933+701954 ou 701904+701954

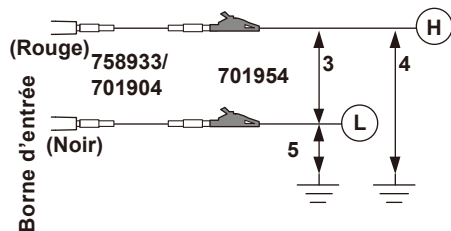

Entrée directe (câble non conforme
aux normes de sécurité)

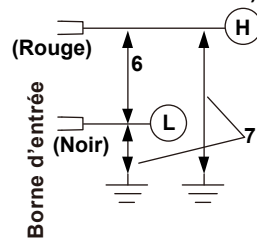

Dépassement de plage

En cas de dépassement de plage, l'instrument risque de recevoir une tension supérieure à la forme d'onde observée ou aux valeurs de forme d'onde mesurées. Pour éviter tout risque de choc électrique, modifier l'échelle de gain vertical à l'aide du bouton SCALE, de sorte que l'amplitude entière de la forme d'onde s'affiche sur l'afficheur, et vérifier le niveau de tension d'entrée.



Dépassement de plage

Indique le numéro de canal sur lequel le dépassement de plage a lieu. Si un dépassement de plage se produit sur plusieurs canaux, le plus petit numéro de canal parmi eux est indiqué comme suit: **CH3**.

3.9 Connecting Thermocouples

Connecting Thermocouples

If you are connecting the compensation lead of the thermocouple to the input terminal (binding post terminal) of the 701261 (UNIVERSAL), 701262 (UNIVERSAL (AAF)), 701265 (TEMP/HPV), or 720266 (TEMP/HPV), loosen the terminal knob, pass the lead through the terminal, and tighten the knob.

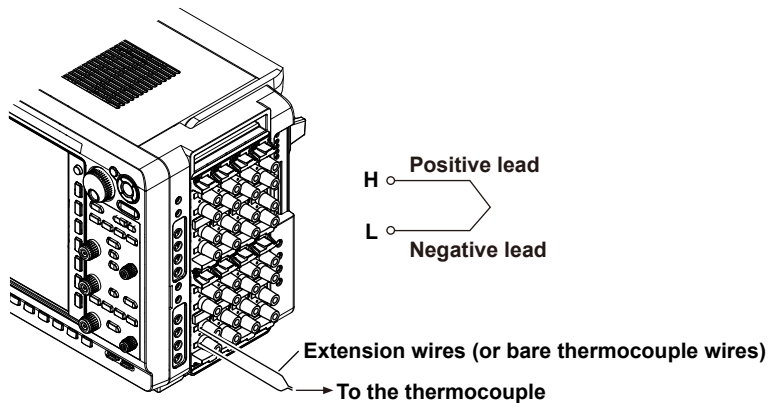

WARNING

If over-range is indicated, the instrument may be receiving a voltage higher than the observed waveform or measured waveform values. To prevent electric shock, check the input voltage level.



Over-range indication

Indicates the number of the channel that over-range is occurring on. If over-range is occurring on multiple channels, the smallest channel number among them is indicated as follows: **CH3**.



CAUTION

- 701261 (UNIVERSAL), 701262 (UNIVERSAL (AAF)), 701265 (TEMP/HPV), or 720266 (TEMP/HPV) is isolated from the instrument. However, applying a voltage exceeding the value below may damage the input section. If the frequency is above 1 kHz, damage may occur even when the voltage is below this value.

Maximum input voltage (across the input terminals, H and L, at a frequency of 1 kHz or less)
42 V (DC+ACpeak)

Maximum rated voltage to ground (across the input terminal L and earth at a frequency of 1 kHz or less)

42 V (DC+ACpeak) (CAT II, 30 Vrms)

- Correct measurements cannot be obtained when the positive and negative thermocouple leads are connected in reverse.
- Immediately after connecting the thermocouple, the heat balance may be disturbed at the input terminal section and may cause measurement errors. Therefore, wait about 10 minutes before making a measurement.
- In an environment where the air from the air conditioning is directly applied to the signal input terminals or where there are effects from a heat source, the heat balance may be disturbed at the input terminal section and cause measurement errors.

When making measurements in this type of environment, take preventive measures such as changing the position.

French



AVERTISSEMENT

En cas de dépassement de plage, l'instrument risque de recevoir une tension supérieure à la forme d'onde observée ou aux valeurs de forme d'onde mesurées. Pour éviter tout risque de choc électrique, vérifier le niveau de tension d'entrée.



Dépassement de plage

Indique le numéro de canal sur lequel le dépassement de plage a lieu.

Si un dépassement de plage se produit sur plusieurs canaux, le plus petit numéro de canal parmi eux est indiqué comme suit: **CH3**.



ATTENTION

- 701261 (UNIVERSAL), 701262 (UNIVERSAL (AAF)), 701265 (TEMP/HPV), ou 720266 (TEMP/HPV) est isolé de l'instrument. Cependant, le fait d'appliquer une tension dépassant la valeur inférieure risque d'endommager la section d'entrée. Si la fréquence est supérieure à 1 kHz, des dommages risquent de survenir même lorsque la tension est inférieure à cette valeur.

Tension d'entrée maximale (via les bornes d'entrée, H et L, à une fréquence d'1 kHz ou moins)
42 V (c.c. + crête c.a.)

Tension nominale maximale à la terre (via la borne d'entrée L et la terre à une fréquence d'1 kHz ou moins)

42 V (c.c. + crête c.a.) (CAT II 30 Vrms)

- Il est impossible d'obtenir des mesures correctes si les fils de thermocouple positifs et négatifs sont branchés à l'envers.
 - Immédiatement après avoir branché le thermocouple, l'équilibreur thermique risque d'être perturbé dans la zone de la borne d'entrée, ce qui risque de causer des erreurs de mesure. C'est pourquoi, il faut attendre environ 10 minutes avant d'effectuer une mesure.
 - Dans un environnement dans lequel l'air provenant de la climatisation est directement appliqué sur les bornes d'entrée ou dans lequel il existe des effets provenant de la source de chaleur, l'équilibreur de chaleur risque d'être perturbé dans la zone de la borne d'entrée, ce qui risque de causer des erreurs de mesure.
Si des mesures sont réalisées dans ce type d'environnement, prendre des mesures préventives telles que le changement de position.
-

3.10 Connecting Bridgeheads

You can measure strain by connecting a strain gauge bridge (bridge head) or a strain gauge transducer to the strain module (701270 (STRAIN_NDIS) or 701271 (STRAIN_DSUB)). This section will mainly describe the procedures and precautions related to the connection of the bridge head (Model 701955, 701956, 701957, and 701958). For the connection of other strain gauge bridges or strain gauge transducers, see the respective manuals.

CAUTION

Only connect a strain gauge bridge (bridge head) or a strain gauge transducer to the strain module. Connecting other devices or applying a voltage that exceeds the values indicated below to the strain module may damage the input section.

Maximum input voltage (between Input+ and Input-)

10 V (DC+AC_{peak})

Maximum rated voltage to ground (between each terminal and earth ground)

42 V (DC+AC_{peak}) (CAT II, 30 V_{rms})

French

ATTENTION

Brancher seulement un pont de jauge de contrainte (tête de pont) ou un transducteur de jauge de contrainte au module de contrainte. Le fait de brancher d'autres appareils ou d'appliquer une tension dépassant les valeurs indiquées ci-dessous sur le module de contrainte risque d'endommager la zone d'entrée.

Tension d'entrée maximale (entre l'entrée + et l'entrée -)

10 V (c.c. + crête c.a.)

Tension nominale maximale à la terre (entre chaque borne et mise à la terre)

42 V (c.c. + crête c.a.) (CAT II 30 V_{rms})

Connecting the Strain Gauge

The bridge head (701955, 701956, 701957, and 701958) supports six types of connection methods: single-gauge method, single-gauge three-wire method, adjacent-side two-gauge method, opposite-side two-gauge method, opposite-side two-gauge three-wire method, and four-gauge method. For details, see the manual that came with the bridge head (701955, 701956, 701957, or 701958).

If you are using a strain gauge bridge or a strain gauge transducer other than the bridge head (701955, 701956, 701957, and 701958), see the respective manuals.

Connecting the Strain Module and the Bridge Head

When Using the Strain Module (701270) and the Bridge Head (701955 or 701956)

Using the cable that came with the bridge head (701955 or 701956), connect the 701270 (STRAIN_NDIS) and the bridge head.

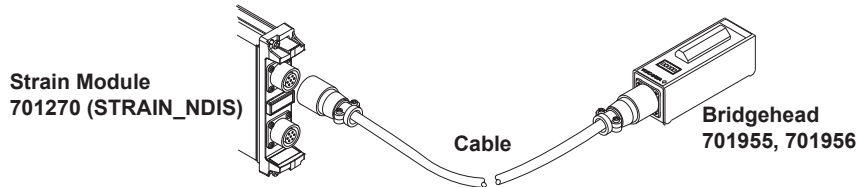

When Using the Strain Module (701271) and the Bridge Head (701957 or 701958)

Using the cable that came with the bridge head (701957 or 701958), connect the 701271 (STRAIN_DSUB) and the bridge head.

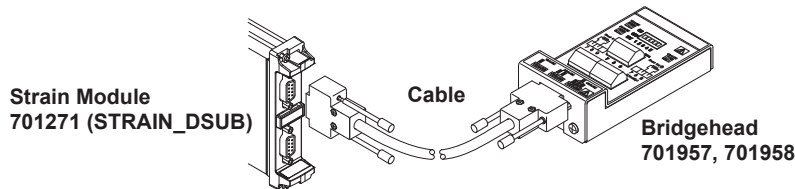

When Using a Bridge Head with a MIL Standard (MIL-C-26482) Connector Wiring

The connector on the 701270 (STRAIN_NDIS) is an NDIS connector.* Use a connector adapter cable (700935) by YOKOGAWA to make a MIL-NDIS conversion and connect to the 701270.

* Connector recommended by JSNDI (Japanese Society for Non-Destructive Inspection)

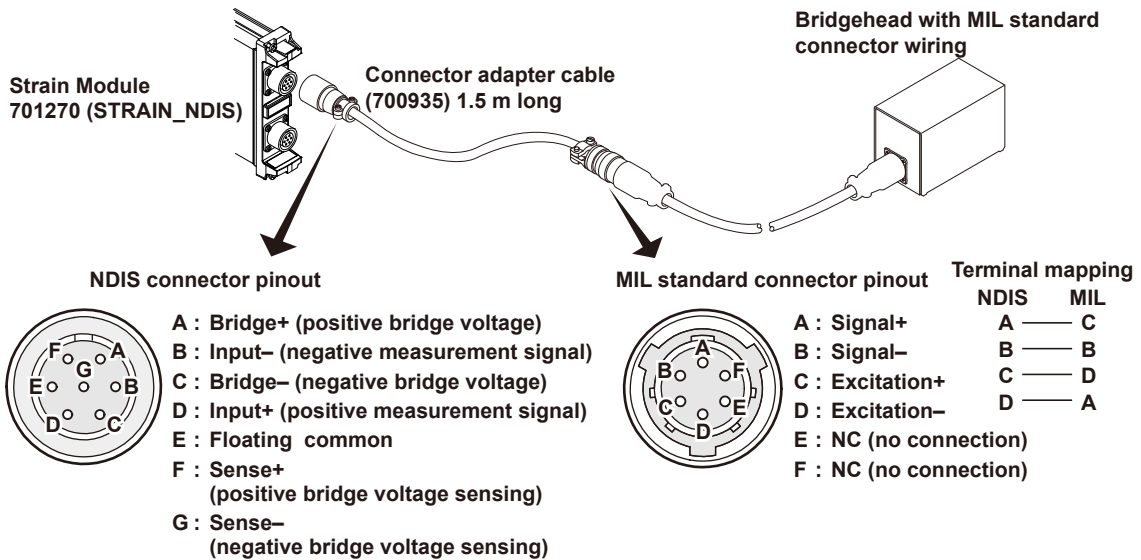

When Using the A1002JC Connector by YOKOGAWA

You can create your own cable by using the YOKOGAWA A1002JC connector that is compatible with the strain module and use the cable to connect a strain gauge bridge or a strain gage transducer to the strain module.

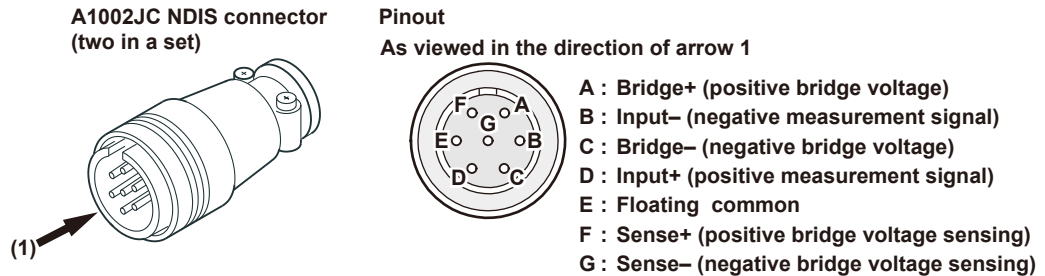

Note

- The connector shell is connected to the case potential of the instrument.
- Each of the signals from A to G is isolated within the module.
- When creating your own cable, we recommend that you use a shielded cable in order to shut out external noise.



CAUTION

Take extra care when wiring the connectors. If the wiring is shorted or incorrect, it can damage the instrument or other instruments that are connected to the instrument.

French



ATTENTION

Redoubler de vigilance lors du câblage des connecteurs. Si le câblage est shunté ou incorrect, il risque d'endommager l'instrument ou d'autres instruments reliés à cet instrument.

Pinout of the D-Sub Connector

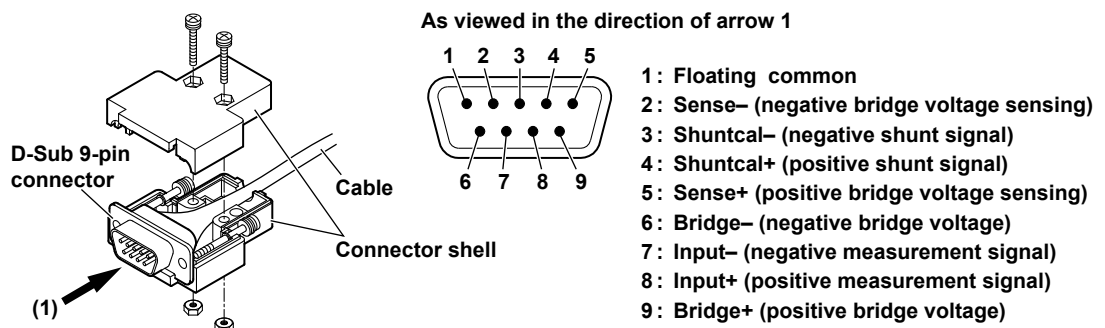

3.11 Connecting a Logic Probe to the Logic Input Module

To measure logic signals, connect a logic probe (the 702911, 702912, 700986, or 700987) to a logic input module (the 720230).



CAUTION

- Applying a voltage greater than the limits listed below may damage the logic probe, logic input module, or the instrument. If the frequency is above 1 kHz, damage may occur even when the voltage is below this value.

Maximum input voltage (at a frequency of 1 kHz or less)

- Logic probes (702911 and 702912): 35 V
 - High-speed logic probe 700986: 42 V (DC+AC_{peak})
 - Isolated logic probe 700987: 250 V_{rms} (however, AC_{peak} must be less than 350 V, and DC must be less than 250 V)
- For logic probes (702911 and 702912), and high-speed logic probe 700986, the eight input lines of a single pod share the same ground. Also, the instrument's ground and the grounds of each pod are connected. Do not apply signals with different common voltages to each input line. Doing so may damage the instrument, logic input modules, logic probes, or connected devices.
 - The input terminals of an isolated logic probe (700987) are isolated from each other and from the instrument.
 - Turn off the instrument before you connect or remove a 26-pin connector from the logic input module.
 - Do not stack the isolated logic probes (700987) during use. Also, allow enough space around the probes to avoid a temperature increase inside the probes.
 - Do not use the YOKOGAWA 700985 logic probe with the instrument. The 700985 is shaped so that it can be connected to a logic Input Module (720230), but it is not electrically compatible with the instrument, so connecting the two could damage the logic input module, the instrument, or the 700985.

French

**ATTENTION**

- L'application d'une tension supérieure aux limites listées ci-dessous pourrait endommager la sonde logique, le module d'entrée logique ou l'instrument. Si la fréquence est supérieure à 1 kHz, des dommages risquent de survenir même lorsque la tension est inférieure à cette valeur.

Tension d'entrée maximale (à une fréquence de 1 kHz ou moins)

- Sondes logiques 702911 et 702912 : 35 V
 - Sonde logique à grande vitesse 700986 : 42 V (c.c. + crête c.a.)
 - Sonde logique isolée 700987 : 250 Vrms (cependant, la valeur crête c.a. doit être inférieure à 350 V et c.c. à 250 V)
- Pour les sondes logiques 702911, 702912 et la sonde logique à grande vitesse 700986, les huit lignes d'entrée d'une cosse unique partagent la même terre. De plus, la terre de l'instrument et celles de chaque cosse sont reliées. Ne pas émettre de signaux de tensions communes différentes vers chaque ligne d'entrée. Cela pourrait endommager l'instrument, les modules d'entrées logiques, les sondes logiques ou les appareils connectés.
 - Les bornes d'entrée d'une sonde logique isolée (700987) sont isolées les unes des autres et de l'instrument.
 - Éteindre l'instrument avant de connecter ou de retirer un connecteur à 26 broches du module d'entrée logique.
 - Ne pas empiler les sondes logiques isolées (700987) lors de leur utilisation. Laisser également suffisamment d'espace autour des sondes pour éviter une augmentation de température à l'intérieur des sondes.
 - Ne pas utiliser la sonde logique YOKOGAWA 700985 avec l'instrument. Ne pas utiliser la sonde logique YOKOGAWA 700985 avec l'instrument. Le 700985 est conçu pour pouvoir être connecté à un module d'entrée logique (720230), mais il n'est pas compatible électriquement avec l'instrument, donc la connexion des deux pourrait endommager le module d'entrée logique, l'instrument ou le 700985.

About the Logic Probe

Types of Logic Probes

YOKOGAWA provides the following four types of probes (as accessories) for connecting to the logic input module.

- Logic probe 702911 (1 m)
- Logic probe 702912 (3 m)
- High-Speed Logic Probe 700986
- Isolated Logic Probe 700987

Types of Measurement Leads That Can Be Used

Use the following leads to connect to the point of measurement.

Types of Connection Leads That Can Be Used with Logic Probes (702911, 702912) and High-Speed Logic Probe 700986

The following two types are available.

- Connecting lead (alligator clip, parts No. B9879PX)
This lead is primarily for connecting to contact circuits. The lead consists of 8 signal lines (red) and 8 earth lines (black).
- Connecting lead (IC clip, parts No. B9879KX)
This lead is primarily for connecting to electronic circuits. The lead consists of 8 signal lines (red) and 2 earth lines (black).

Types of Measurement Leads That Can Be Used on the Isolated Logic Probe 700987

Use the following measurement lead.

- For measuring voltages of 42 V or more: Measurement lead for isolation logic 758917
An alligator adapter (758922), alligator adapter (758929), or alligator clip (dolphin type, 701954) is needed to make measurements.

Note

Do not modify the connecting leads. Doing so may degrade their specifications.

Connecting Logic Probes

Logic Probes (702911, 702912) and High-Speed Logic Probe 700986

1. Attach the connecting lead (IC clip or alligator clip) that came with the logic probe, and push the logic probe levers inwards to lock the connector into place. To remove the connecting leads from the logic probe, push both of the levers outwards. Proceed to step 3.

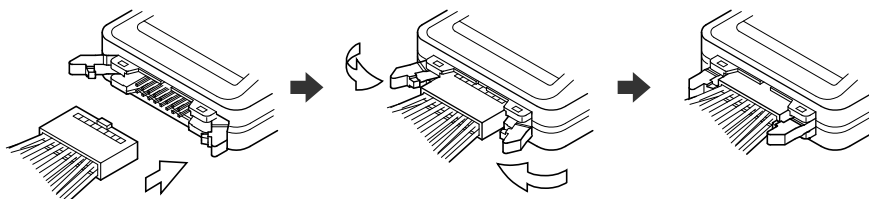

Isolated Logic Probe 700987

1. Connect the measurement leads to the logic probe's input terminal.
2. Set the input switch. When you set it to AC, the threshold levels are 50 VAC \pm 50 % (Hi: 80 to 250 VAC, Lo: 0 to 20 VAC); when you set it to DC, the threshold levels are 6 V \pm 50 % (Hi: 10 to 250 VDC, Lo: 0 to 3 VDC).

Connecting the Logic Probe to a Logic Input Module

3. Turn the instrument's power switch off.
4. Connect to the logic signal input connector of the logic input module (720230) the end of the logic probe's 26-pin connector that has a clamp filter (ferrite core; part number: A1190MN).
5. Turn on the instrument.

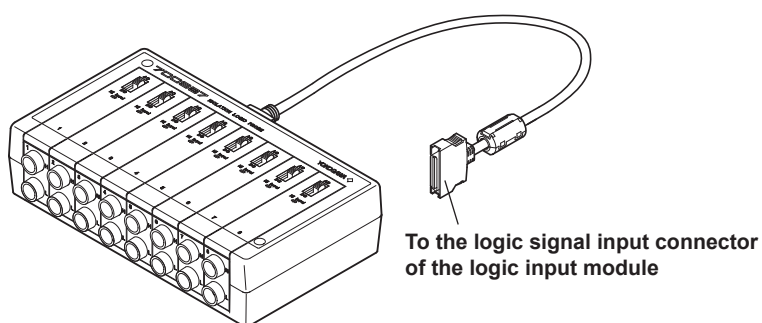

Note

- When a logic probe is not connected to the instrument, each bit is indicated as being at the high level.
- For the logic probe specifications, see section 7.16, "Logic Probe Specifications."
- Before using logic probes (702911, 702912) or isolated logic probe 700987, flip the switch back and forth several times. The switch's electrical contacts can weaken if not used for long periods of time.

3.12 Connecting an Acceleration Sensor

An acceleration sensor is connected when measuring acceleration on the acceleration/voltage module (with AAF) (701275 (ACCL/VOLT)). For a details on acceleration sensors, see the respective manuals.



WARNING

If over-range is indicated, the instrument may be receiving a voltage higher than the observed waveform or measured waveform values. To prevent electric shock, change the vertical scale with the SCALE knob so that the entire amplitude of the waveform is displayed within the waveform display area, and check the input voltage level.



Over-range indication

Indicates the number of the channel that over-range is occurring on. If over-range is occurring on multiple channels, the smallest channel number among them is indicated as follows: **CH3**.



CAUTION

- Applying a voltage that exceeds the values indicated below to the 701275 (ACCL/VOLT) may damage the input section.
Maximum input voltage: 42 V (DC+ACpeak)
- When connecting acceleration sensors, do it without the bias current being supplied to the sensor. Otherwise, damage to the internal circuitry of the acceleration sensors may result.
- This instrument only supports acceleration sensors that are driven by constant current with driving current of 4 mA and driving voltage of 22 V.

French



AVERTISSEMENT

En cas de dépassement de plage, l'instrument risque de recevoir une tension supérieure à la forme d'onde observée ou aux valeurs de forme d'onde mesurées. Pour éviter tout risque de choc électrique, modifier l'échelle de gain vertical à l'aide du bouton SCALE, de sorte que l'amplitude entière de la forme d'onde s'affiche sur l'afficheur, et vérifier le niveau de tension d'entrée.



Dépassement de plage

Indique le numéro de canal sur lequel le dépassement de plage a lieu. Si un dépassement de plage se produit sur plusieurs canaux, le plus petit numéro de canal parmi eux est indiqué comme suit: **CH3**.



ATTENTION

- Le fait d'appliquer une tension dépassant les valeurs indiquées ci-dessous sur 701275 (ACCL/VOLT) risque d'endommager la zone d'entrée.
Tension d'entrée maximum: 42 V (c.c. + crête c.a.)
- Lors du branchement des capteurs d'accélération, faire en sorte que le courant de polarisation n'alimente pas le capteur. Cela risquerait en effet d'endommager les circuits internes des capteurs d'accélération.
- Cet instrument ne prend en charge que les capteurs d'accélération alimentés par un courant constant avec un courant d'entraînement de 4 mA et une tension d'entraînement de 22 V.

Connecting Acceleration Sensors

When Connecting Built-in Amplifier Type Acceleration Sensors

This instrument allows built-in amplifier type (low impedance) acceleration sensors to be directly connected. To connect built-in amplifier type acceleration sensors, use BNC cables. Use cables that are appropriate for the acceleration sensors being used.

Connect the acceleration sensors with the bias current turned off. After connection, turn on the supply current to the acceleration sensors for making measurements.

When Connecting Charge Output Type Acceleration Sensors

Since the charge output type (high impedance) acceleration sensors do not have built-in amplifier circuit, they cannot be directly connected to this instrument. Use either of the following two methods to connect the sensors.

Using the Charge Amplifier

Connect a charge-output-type acceleration sensor to the charge amplifier using a high-insulation, low-noise cable. The acceleration signal (charge signal) that has been converted to a voltage signal by the charge amplifier is input to the instrument using a normal coaxial cable. The instrument measures the signal in the voltage measurement mode. The measured data can be converted to acceleration values using the scale conversion function of the instrument.

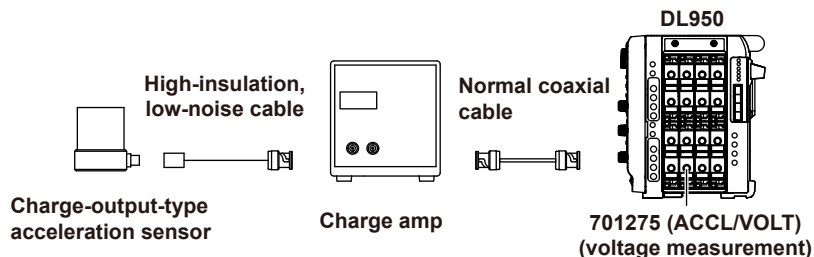

Using the Charge Converter

Connect a charge-output-type acceleration sensor to the charge converter using a high-insulation, low-noise cable. By driving the charge converter using a constant current from the instrument, voltage signals similar to those of the built-in amplifier type acceleration sensor can be obtained. This instrument measures the signals in the acceleration measurement mode and supplies bias current to the charge converter. Set the input sensitivity of the instrument according to the charge converter gain and the sensitivity of the charge output type acceleration sensor.

This instrument only supports charge converters that are driven by constant current with driving current of 4 mA and driving voltage of 22 V.

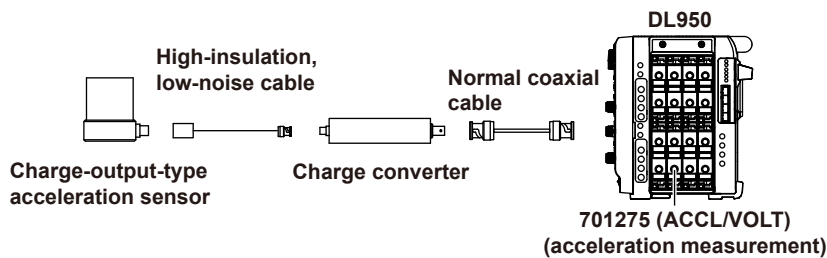

Note

The unit of measurement of acceleration on the instrument is m/s^2 . If the sensitivity is indicated in mV/G for the acceleration sensor that you are using, convert it. ($1 \text{ G} = 9.81 \text{ m/s}^2$)

Precautions

- Do not apply shock outside the specifications (see the manual for the acceleration sensor) to the acceleration sensors. Doing so can damage the sensors.
- Do not impose drastic temperature changes on the acceleration sensors. Temperature changes may affect the output value of the acceleration sensors.
- By default, the bias current on the acceleration sensors is turned off. Be sure to turn it on before using the acceleration sensors. Bias current is valid only when measuring acceleration. When measuring other parameters, it is automatically turned off. The bias current on/off setting is saved when the instrument is turned off.

3.13 Connecting Sensors to the Frequency Module

Sensors and Signal Output Sources That Can Be Connected

The table below shows the sensor and signal output source that can be connected. Appropriate input presets are provided for each sensor and signal output source. For information on how to set presets, see “Input Settings (Input Setup)” in section 2.7, “Configuring Frequency, Revolution, Period, Duty Cycle, Power Supply Frequency, Pulse Width, Pulse Integration, and Velocity Measurements,” in the user’s manual.

Sensor and Signal Output Source	Preset Name
5-V logic signal, 5-V output sensor, and sensor with TTL output	Logic 5V
3-V logic signal and 3-V output sensor	Logic 3V
12-V driven relay/sequence circuit and 12-V driven sensor	Logic 12V
24-V driven relay/sequence circuit and 24-V driven sensor	Logic 24V
Sensor/Encoder that outputs positive and negative voltages and sensor that outputs sine waves	ZeroCross
100-VAC (connected through the isolated probe (700929 or 701947) or passive probe power supply 702902)	AC100V
200-VAC (connected through the isolated probe (700929 or 701947) or passive probe power supply 702902)	AC200V
Power-generating electromagnetic pickup	EM Pickup
Open collector (0 to 5 V) output sensor, contact output	Pull-up 5V*

* For the internal equivalent circuit when the preset setting is Pull-up 5V, see the “Frequency Measurement” section in chapter 2, “Channel Setup” in the feature’s guide (IM DL950E-01EN).



WARNING

If over-range is indicated, the instrument may be receiving a voltage higher than the observed waveform or measured waveform values. To prevent electric shock, change the vertical scale with the SCALE knob so that the entire amplitude of the waveform is displayed within the waveform display area, and check the input voltage level.

When a measurement is made with the frequency module, over-range is also displayed when the calculated value exceeds the display range of the screen (10 div). When the input voltage level is over-range, the module LED illuminates in red (see page 3-12).



Over-range indication

Indicates the number of the channel that over-range is occurring on. If over-range is occurring on multiple channels, the smallest channel number among them is indicated as follows: **CH3**.

French



AVERTISSEMENT

En cas de dépassement de plage, l'instrument risque de recevoir une tension supérieure à la forme d'onde observée ou aux valeurs de forme d'onde mesurées. Pour éviter tout risque de choc électrique, modifier l'échelle de gain vertical à l'aide du bouton SCALE, de sorte que l'amplitude entière de la forme d'onde s'affiche sur l'afficheur, et vérifier le niveau de tension d'entrée.

Lorsqu'une mesure est effectuée avec le module de fréquence, le dépassement de plage est également affiché lorsque la valeur calculée dépasse la plage d'affichage de l'écran (10 div). Lorsque le niveau de tension d'entrée dépasse la plage, la LED du module s'allume en rouge (voir la page 3-12).



Dépassement de plage

Indique le numéro de canal sur lequel le dépassement de plage a lieu. Si un dépassement de plage se produit sur plusieurs canaux, le plus petit numéro de canal parmi eux est indiqué comme suit: **CH3>>**.

Precautions to Be Taken When Connecting to Sensors or Signal Output Sources



CAUTION

- The maximum input voltage for direct input is indicated below. Applying a voltage exceeding this value can damage the input section. To apply high voltage that is 42 V or higher, be sure to connect through an isolated probe (700929 or 701947) or passive probe 702902.
Maximum input voltage: 42 V (DC+ACpeak) (CAT II)
 - The minimum input voltage is 0.2 Vpp. At voltage amplitude less than 0.2 Vpp, the measured values may be unstable.
 - Attach/Remove the sensors after confirming that the rotating object to be measured is stopped.
 - Set the preset to electromagnetic pickup (EM Pickup) only when using the electromagnetic pickup.
-

French

**ATTENTION**

- La tension d'entrée maximale de l'entrée directe est indiquée ci-dessous. Le fait d'appliquer une tension dépassant cette valeur risque d'endommager la section d'entrée. Pour appliquer une tension élevée de 42 V au moins, bien réaliser le branchement à l'aide d'une sonde isolée (700929 ou 701947) ou d'une sonde passive 702902.
Tension d'entrée maximum: 42 V (c.c. + crête c.a.) CAT II
- La tension d'entrée minimale est 0,2 Vpp. Pour une amplitude de tension inférieure à 0,2 Vpp, les valeurs mesurées risquent d'être instables.
- Brancher/retirer les capteurs après avoir confirmé que l'objet rotatif à mesuré a été arrêté.
- Prérégler le paramétrage sur détection électromagnétique (EM Pickup) uniquement lors de l'utilisation de la détection électromagnétique.

Connecting the Electromagnetic Pickup

- This instrument allows power-generating electromagnetic pickup to be connected directly. It does not support electromagnetic pickups that require external power supply or those that require a terminator at the output.
- To connect electromagnetic pickups, use BNC cables. Use cables that are appropriate for the electromagnetic pickups being used.
- When the input is set to electromagnetic pickup, determination is not made on whether the input voltage level exceeds the specified input voltage range. Therefore, the LEDs (see page 3-12) do not illuminate in red even when the input voltage level is over range.

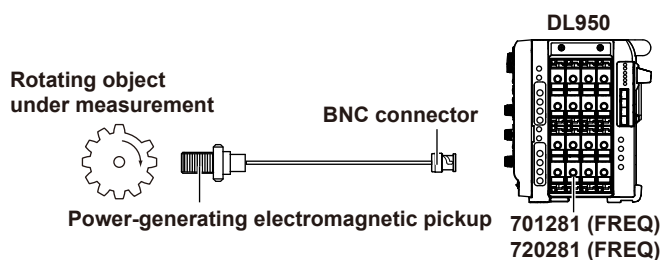

3.14 Connecting Wires to the 16-CH Temperature/Voltage Input Module

If you are using the 720221 (16CH TEMP/VOLT) to measure temperature and voltage, connect thermocouples or wires to the 16-channel scanner box.



WARNING

When connecting a device under measurement to the instrument, be sure to turn off the device. It is extremely dangerous to connect or disconnect thermocouples or wires while the device under measurement is on.

Precautions to Be Taken When Using the Modules

- To avoid electric shock, be sure to ground the instrument.
- To prevent the possibility of electric shock, be sure to fasten the module screws. Otherwise, the electrical and mechanical protection functions will not be activated.

Precautions to Be Taken When Using the 16-CH Scanner Box

- Do not connect or disconnect the 16-CH scanner box or the cables that are connected to it while the power is on.
- Do not apply voltage exceeding the maximum input voltage or maximum rated voltage to ground.
- Avoid continuous connection in an environment where a surge voltage may occur.
- To prevent electric shock, connect wires to the terminal block that match the voltage range that you are measuring.
- Applying a voltage exceeding the value indicated below may damage the input section. If the frequency is above 1 kHz, damage may occur even when the voltage is below this value.

Maximum input voltage (across the input terminals, + and -,¹ at a frequency of 1 kHz or less)

- 42 V (DC+ACpeak)

Maximum rated voltage to ground (across the input terminals, + or -, and earth,² at a frequency of 1 kHz or less)

- 42 V (DC+ACpeak) (CAT II, 30 Vrms)

- The - input terminals of the sub channels are electrically insulated inside the scanner box. If you connect a wire that has a potential difference greater than 42 V (DC+ACpeak) between sub channels, the insulation may be damaged, which will lead to the 16-CH scanner box being damaged.

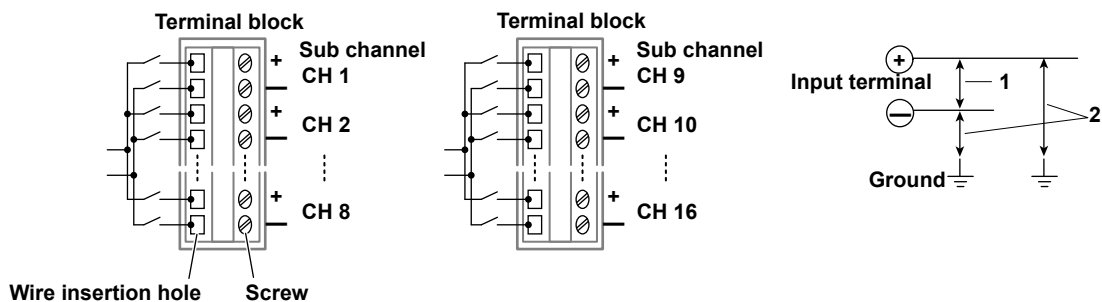

Over-Range Indication

If over-range is indicated, the instrument may be receiving a voltage higher than the observed waveform or measured waveform values. To prevent electric shock, change the vertical scale with the SCALE knob so that the entire amplitude of the waveform is displayed within the waveform display area, and check the input voltage level.

**Over-range indication**

Indicates the number of the channel that over-range is occurring on. If over-range is occurring on multiple channels, the smallest channel number among them is indicated as follows: **CH3**.

**CAUTION**

- Correct measurements cannot be obtained when the positive and negative thermocouple leads are connected in reverse.
- Immediately after connecting the thermocouple, the heat balance may be disturbed at the input terminal section and may cause measurement errors. Therefore, wait about 10 minutes before making a measurement.
- In an environment where the air from the air conditioning is directly applied to the input terminals or where there are effects from a heat source, the heat balance may be disturbed at the input terminal section and cause measurement errors.

When making measurements in this type of environment, take preventive measures such as changing the position.

French**AVERTISSEMENT**

Lors de la connexion à l'instrument d'un appareil faisant l'objet de la mesure, éteindre impérativement l'appareil. Il est extrêmement dangereux de brancher ou débrancher des thermocouples ou des câbles lorsque l'appareil en cours de mesure est allumé.

Précautions à prendre lors de l'utilisation des modules

- Pour éviter tout risque de choc électrique, l'instrument doit impérativement être relié à la terre.
- Pour éviter tout risque de choc électrique, toujours serrer les vis des modules, à défaut de quoi les fonctions de protection électrique et de protection mécanique ne seront pas activées.

Précautions à prendre lors de l'utilisation de boîtier de scanner 16-CH

- Ne pas brancher ou débrancher le boîtier de scanner 16-CH ou les câbles qui y sont reliés s'ils sont sous tension.
- Ne pas appliquer une tension dépassant la tension d'entrée maximum ou la tension nominale à la terre maximum.
- Évitez un branchement continu dans un environnement pouvant être soumis à une surtension.
- Afin d'éviter un risque de choc électrique, raccorder les câbles au bornier qui correspondent à la plage de tensions en cours de mesure.

3.14 Connecting Wires to the 16-CH Temperature/ Voltage Input Module

- L'application d'une tension supérieure à la valeur indiquée ci-dessous pourrait endommager la section d'entrée. Si la fréquence est supérieure à 1 kHz, des dommages risquent de survenir même lorsque la tension est inférieure à cette valeur.

Tension d'entrée maximale (via les bornes d'entrée, + et -,¹ à une fréquence d'1 kHz ou moins)

- 42 V (c.c. + crête c.a.)

Tension nominale maximale à la terre (via les bornes d'entrée, + ou -, et la terre,² à une fréquence d'1 kHz ou moins)

- 42 V (c.c. + crête c.a.) (CAT II 30 Vrms)

- Les bornes d'entrée – des sous-voies sont électriquement isolées à l'intérieur du boîtier de scanner. En cas de branchement d'un câble présentant une différence de potentiel supérieure à 42 V (c.c. + crête c.a.) entre les sous-voies, l'isolation risque d'être endommagée, ce qui causera des dégâts sur le boîtier de scanner 16-CH.

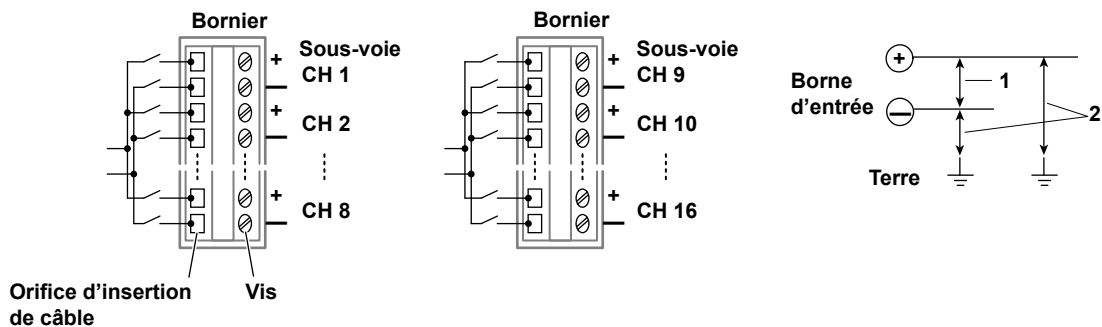

Dépassement de plage

En cas de dépassement de plage, l'instrument risque de recevoir une tension supérieure à la forme d'onde observée ou aux valeurs de forme d'onde mesurées. Pour éviter tout risque de choc électrique, modifier l'échelle de gain vertical à l'aide du bouton SCALE, de sorte que l'amplitude entière de la forme d'onde s'affiche sur l'afficheur, et vérifier le niveau de tension d'entrée.



Dépassement de plage

Indique le numéro de canal sur lequel le dépassement de plage a lieu. Si un dépassement de plage se produit sur plusieurs canaux, le plus petit numéro de canal parmi eux est indiqué comme suit: **CH3**.



ATTENTION

- Il est impossible d'obtenir des mesures correctes si les fils de thermocouple positifs et négatifs sont branchés à l'envers.
 - Immédiatement après avoir branché le thermocouple, l'équilibreur thermique risque d'être perturbé dans la zone de la borne d'entrée, ce qui risque de causer des erreurs de mesure. C'est pourquoi, il faut attendre environ 10 minutes avant d'effectuer une mesure.
 - Dans un environnement dans lequel l'air provenant de la climatisation est directement appliqué sur les bornes d'entrée ou dans lequel il existe des effets provenant de la source de chaleur, l'équilibreur de chaleur risque d'être perturbé dans la zone de la borne d'entrée, ce qui risque de causer des erreurs de mesure.
- Si des mesures sont réalisées dans ce type d'environnement, prendre des mesures préventives telles que le changement de position.

What to Prepare

Thermocouple or Wiring

Remove approximately 7 mm of the insulation from the ends of the thermocouple or wires.
 Electrical wire: 0.14 mm² to 1.5 mm² recommended (solid wire or thin stranded wire).
 AWG size: 26-16.

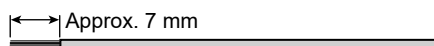

Flat-blade Screwdriver

Tip size: 0.6 mm (thickness) × 3.5 mm (width)
 Screw tightening torque: 0.5 to 0.6 N·m

Connecting Wires to the Terminal Block

First, turn off the instrument, and make sure that the other end of the wire that you are connecting to the terminal block is not connected to the device under measurement or that the device under measurement that you are going to connect to is turned off.

When you first use the 16-CH scanner box, follow the procedure from step 3.

1. Remove the protection cover screw using a screwdriver.
2. Pull the protection cover up, and pull it out from the guide hole.

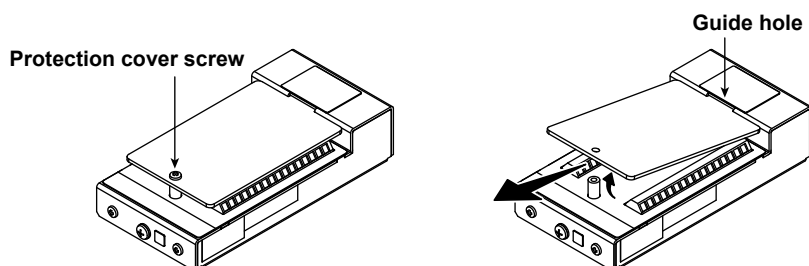

3. Loosen the terminal block screw using a flat-blade screwdriver.
4. Insert the thermocouple or wire that you prepared into the wire insertion hole. Insert the thermocouple or wire until its end reaches the back of the wire insertion hole.
5. Tighten the terminal block screw using a flat-blade screwdriver.

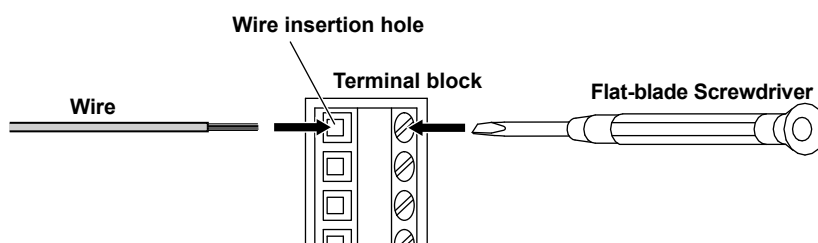

3.14 Connecting Wires to the 16-CH Temperature/ Voltage Input Module

6. Pull lightly on the thermocouple or wire to make sure that it doesn't come out.
7. Insert the protection cover into the guide hole.
8. Tighten the protection cover screw using a screwdriver.

Fixing the Scanner Box in Place

If necessary, you can use the accessory attaching plate, B8074LN, to fix the scanner box to the panel.

1. Align the small holes on the bottom side of the scanner box to the small projections of the attaching plate.
2. Screw the scanner box and the attaching plate together using the accessory binding screws (M4 × 5 mm).

Screw tightening torque: 1.2 N·m

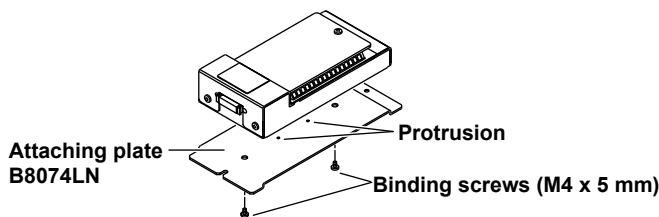

Connecting the 16-CH Temperature/Voltage Input Module and the Scanner Box

Using the cable that came with the 16-CH scanner box (701953), connect the 720221 (16CH TEMP/VOLT) and the 16-CH scanner box.

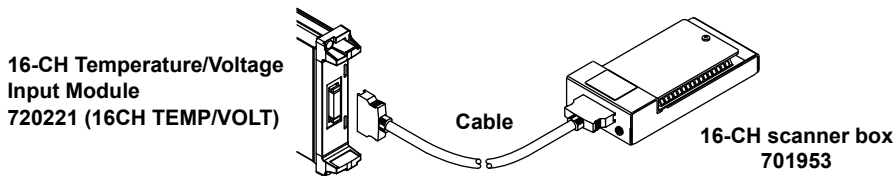

3.15 Connecting a Cable to the CAN Bus Monitor or CAN/CAN FD Bus Monitor Module

To monitor CAN bus signals, connect a cable to D-sub connector of the CAN bus monitor or CAN/CAN FD monitor module. To monitor CAN/CAN FD bus signals, connect a cable to the D-sub connector of the CAN/CAN FD monitor module.

Connector Pinout

The pinout of the D-sub connector (9 pin, male) is shown below.

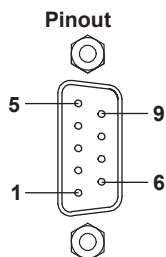

Pin No.	Signal	Function
1	(NC)	Not used (cannot be connected to)
2	CAN_L	CAN low signal
3	GND	Ground
4	(NC)	Not used (cannot be connected to)
5	(NC)	Not used (cannot be connected to)
6	GND	Ground
7	CAN_H	CAN high signal
8	(NC)	Not used (cannot be connected to)
9	(NC)	Not used (cannot be connected to)

* One-inch screws (number 4-40 UNC) are used.

Note

The connector shell is connected to GND. Additionally, GND and the connector shell are isolated from the electric potential of the DL950 case (earth).



CAUTION

Applying a voltage greater than the maximum input voltage may damage the input section.

French



ATTENTION

Le fait d'appliquer une tension dépassant la tension d'entrée maximale risque d'endommager la section d'entrée.

Connecting the Cable (Signal wires)

When you connect a cable to the D-sub connector, be sure to tighten the screws to ensure that the cable is connected securely.

720240 CAN Bus Monitor Module
(CAN MONITOR)
720242 CAN/CAN FD Monitor Module
(CAN/CAN FD)

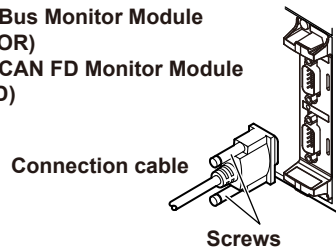

3.16 Connecting a Cable to the CAN & LIN Bus Monitor Module

To monitor CAN or LIN bus signals, connect a cable to the CAN & LIN bus monitor module's D-sub connector.

Connector Pinout

The pinout of the D-sub connector (9 pin, male) is shown below.

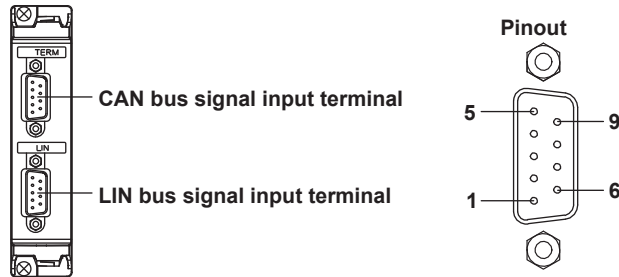

Pin No.	CAN bus signal input terminal		LIN bus signal input terminal	
	Signal	Function	Signal Name	Function
1	(NC)	Not used (cannot be connected to)	LIN	LIN signal
2	CAN_L	CAN low signal	(NC)	Not used (cannot be connected to)
3	CAN_GND	Ground	LIN_GND	Ground
4	(NC)	Not used (cannot be connected to)	VBAT	Battery supply voltage
5	(NC)	Not used (cannot be connected to)	(NC)	Not used (cannot be connected to)
6	CAN_GND	Ground	LIN_GND	Ground
7	CAN_H	CAN high signal	(NC)	Not used (cannot be connected to)
8	(NC)	Not used (cannot be connected to)	(NC)	Not used (cannot be connected to)
9	(NC)	Not used (cannot be connected to)	(NC)	Not used (cannot be connected to)

* One-inch screws (number 4-40 UNC) are used.

Note

The shell of the CAN bus signal input connector is connected to CAN_GND. The shell of the LIN bus signal input connector is connected to LIN_GND. Additionally, CAN_GND and its connector shell and LIN_GND and its connector shell are isolated from the electric potential of the DL950 case (earth).



CAUTION

Applying a voltage greater than the maximum input voltage may damage the input section.

3.16 Connecting a Cable to the CAN & LIN Bus Monitor Module

French



ATTENTION

Le fait d'appliquer une tension dépassant la tension d'entrée maximale risque d'endommager la section d'entrée.

Connecting the Cable (Signal wires)

When you connect a cable to the D-sub connector, be sure to tighten the screws to ensure that the cable is connected securely.

CAN & LIN Bus Monitor Module
720241 (CAN & LIN)

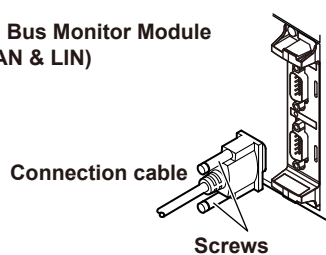

3.17 Affixing the Panel Sheet

Affix the supplied panel sheet to the instrument as necessary. The panel sheet that comes with the instrument is determined by language suffix code.

Affixing the Panel Sheet

You can affix the panel sheet over the panel sheet that is affixed to the instrument when it is shipped from the factory.

- If the operation panel is stained, wipe gently with a soft, dry, clean cloth.
- Make sure that the panel sheet does not make contact with the keys or knobs. If it does, reaffix the panel sheet.

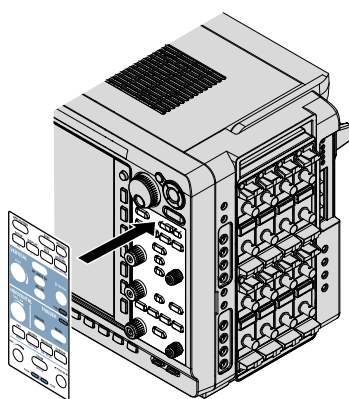

Panel sheet

Note

If you peel off and affix the panel sheet numerous times, the sheet will lose its adhesive strength and will come off more easily.

3.18 Connecting the GPS Unit (/35 option)

To synchronize the clock using GPS, connect the GPS unit, sold separately, to the GPS terminal.

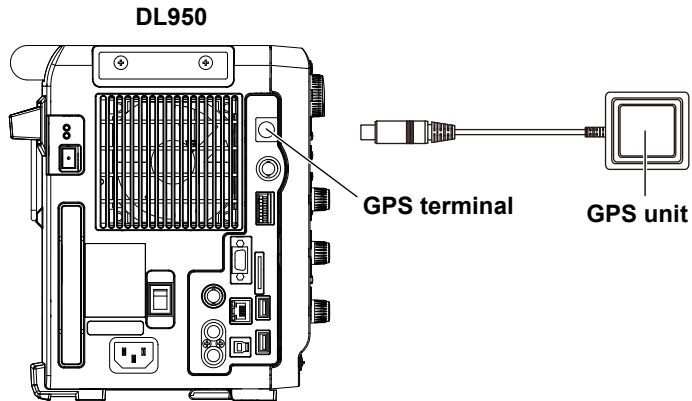

CAUTION

- Attach or remove the GPS unit from the instrument with the power turned off.
- If installed indoors, place the GPS unit near a window or a location where it has a good line of sight to GPS satellites. Otherwise, time synchronization may not work properly.

French

ATTENTION

- Brancher l'unité GPS à l'instrument ou l'en retirer lorsque l'appareil est hors tension.
- Si elle est installée à l'intérieur, placer l'unité GPS à proximité d'une fenêtre ou d'un endroit où la réception des satellites GPS est bonne. Sinon, la synchronisation des durées risque de ne pas se faire correctement.

3.19 Installing a Optical Transceiver Module and Connecting an Optical Fiber Cord (/C50, /C60 option)

This instrument has two types of optical ports (SFP and SFP+ port). Because the transmission speed varies depending on the optical port, install and use the appropriate optical transceiver module.

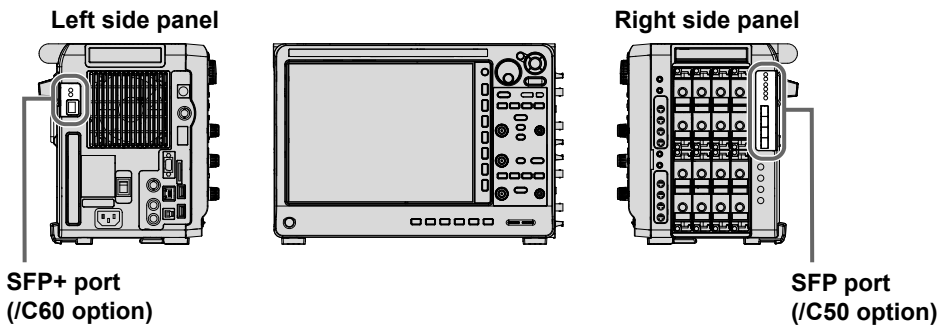

Optical Port	Transfer rate	Port Position	Number of Ports	Purpose
SFP port (/C50 option)	1Gbps	right side panel	4	Multi-unit synchronization operation (up to five units)
SFP+ port (/C60 option)	10Gbps	left side panel	1	10 Gbps Ethernet communication

Note

- Attach a 720941 optical transceiver module, an accessory sold separately, to this instrument's SFP port. If you use a different optical transceiver module, the instrument's functions and performance are not guaranteed.
- If you are using the instrument's SFP+ port, purchase an off-the-shelf optical transceiver module (10GBASE-R SFP+ compatible), and attach that to the port. The 720941 optical transceiver module, an accessory sold separately, does not support SFP+(10GBASE-R).



CAUTION

When using multi-unit synchronization, connect the main unit and all the sub units to be synchronized with optical fiber cords first and then execute the multi-unit synchronization connection procedure. The instrument may not operate properly if you insert or remove optical transceiver modules or optical fiber cords after executing the connection procedure.

French



ATTENTION

Lors de l'utilisation de la synchronisation des multiunités, connecter d'abord l'unité principale et toutes les sous-unités à synchroniser avec des cordons de fibre optique, ensuite exécuter la procédure de connexion de synchronisation des multiunités. L'instrument ne pourrait pas fonctionner correctement si vous insérez ou retirez des modules d'émetteur-récepteur optique ou des cordons de fibre optique après avoir exécuté la procédure de connexion.

Installing the Optical Transceiver Module



CAUTION

- Be extremely careful of static electricity when you install or remove optical transceiver modules. Electrostatic discharges during the installation or removal of these modules may cause them to malfunction.
- Do not install or remove optical transceiver modules while optical fiber cords are connected to them. Doing so may damage the instrument.
- Do not install or remove optical transceiver modules while a measurement is in progress. Doing so may damage the instrument. When installing or removing an optical transceiver module, turn off the instrument.

French



ATTENTION

- Se méfier extrêmement de l'électricité statique lors d'installer ou retirer des modules d'émetteur-récepteur optiques. La décharge électrostatique lors de l'installation ou du retrait de ces modules pourrait causer leur dysfonctionnement.
- Ne pas installer ou ne pas retirer les modules d'émetteur-récepteur optique lorsque des cordons de fibre optique y sont connectés. Cela pourrait endommager l'instrument.
- Ne pas installer ou ne pas retirer les modules d'émetteur-récepteur optiques lorsqu'une mesure est en cours. Cela pourrait endommager l'instrument. Lors de l'installation ou du retrait d'un module d'émetteur-récepteur optique, éteindre l'instrument.

How to Install the Optical Transceiver Module

1. Make sure that the instrument's power switch is turned off.
2. Tilt the latch lever of the optical transceiver module as shown below.
A protection cover is attached to the optical transceiver module (720941), an accessory sold separately. Remove it when connecting the optical fiber cord.
3. Check that the optical transceiver module is in the correct orientation, and slowly insert the module into the instrument's SFP or SFP+ port.
4. Push the optical transceiver module in until you hear a click.

Example of Installing to an SFP Port (/C50 option)

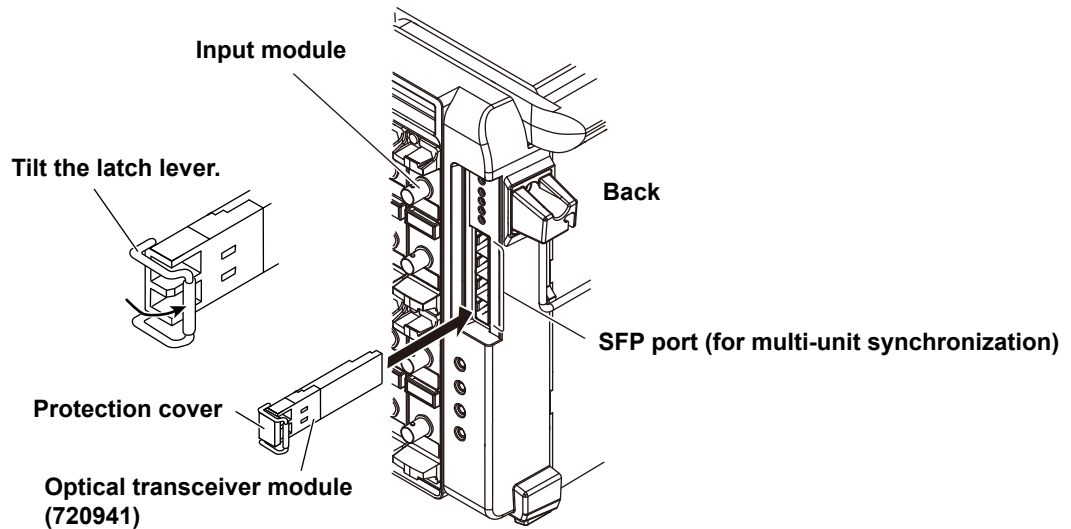

How to Remove the Optical Transceiver Module

1. Make sure that the instrument's power switch is turned off.
If an optical fiber cord is connected, be sure to remove it.
2. Raise the latch lever to release the lock.
3. Pull the optical transceiver module straight out.

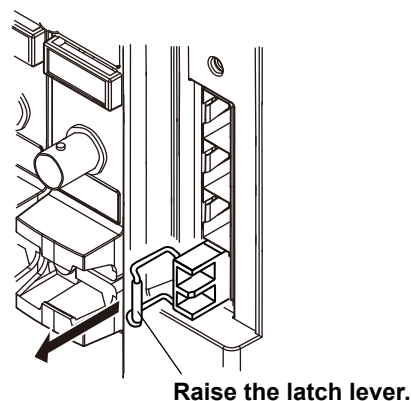

Connecting an Optical Fiber Cord



WARNING

- If optical transceiver modules are installed in the instrument, light is emitted from the optical ports when the instrument is turned on. Do not disconnect the connected optical fiber cord. Visual impairment may occur if the light enters the eye.
 - If an optical fiber cord is not connected, attach the protection cover to the optical transceiver module. Visual impairment may occur if light that is mistakenly emitted from the optical ports enters the eye.
-



CAUTION

- Do not pull, twist, or bend optical fiber cords with excessive force. Doing so may break the cord.
 - Insert the optical fiber cord connector slowly and straight into the optical port by holding the connector part. If you shake the connector to the left and right or force it into the port, the connector or optical port may be damaged.
-

French



AVERTISSEMENT

- Si des modules d'émetteur-récepteur optiques sont installés dans l'instrument, de la lumière est émise par les orifices optiques lorsque l'instrument se démarre. Ne pas déconnecter le cordon de fibre optique connecté. Une déficience visuelle pourrait se présenter si la lumière pénètre dans l'œil.
 - Si un cordon de fibre optique n'est pas connecté, attachez le couvercle de protection au module d'émetteur-récepteur optique. Une déficience visuelle pourrait se présenter si de la lumière émise par les orifices optiques pénètre accidentellement dans l'œil.
-



ATTENTION

- Ne pas tirer, ne pas tordre ou ne pas plier les cordons de fibre optique avec une force excessive. Cela pourrait casser le cordon.
 - Insérer lentement et droit le connecteur du cordon de fibre optique dans l'orifice optique en tenant le connecteur. Si vous secouez le connecteur vers la gauche et la droite ou si vous le forcez dans l'orifice, le connecteur ou l'orifice optique pourrait être endommagé.
-

Clean the Connector End Face

Clean the connector end face of the optical fiber cord before connecting it to the instrument. If dust is adhered to the connector end face, it may damage the optical port. If this happens, the instrument will not be able to make correct measurements.

1. Firmly press the connector end face of the optical fiber cord against the cleaning surface of the cleaner.
2. With the end face pressed, rub it several times, turning it in small amounts.
3. With the end face pressed, slide it along the cleaning surface.
4. Repeat steps 1 to 3.

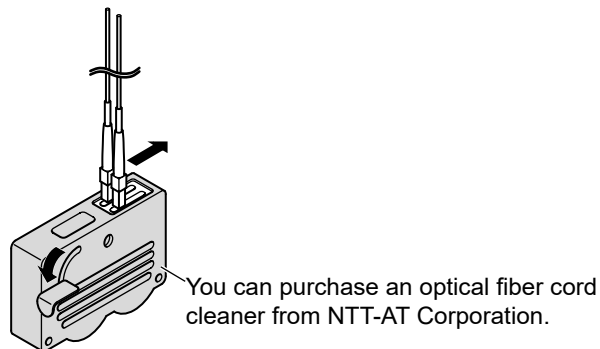

Note

- Connect 720942 optical fiber cords, sold separately, to SFP ports that have 720941 optical transceiver modules, which are also accessories sold separately, installed. When connecting an off-the-shelf optical fiber cord, use a multi-mode LC connector type cord (up to 20 m). Single-mode optical fiber cords cannot be used.
- When using the optical transceiver module (10GBASE-R SFP+ compatible) that you purchased, purchase an appropriate off-the-shelf optical fiber cord to connect to its SFP+ port.

How to Connect an Optical Fiber Cord

1. Make sure that the instrument's power switch is turned off.
2. Make sure that the fiber optic cord connector is oriented correctly, and then slowly insert it into the fiber optic module installed in the instrument.
 - For details on how to install the optical transceiver module, see page 3-69.
 - If a protection cover is attached to the optical transceiver module, remove it.
3. Push the connector until you hear a click.
4. When removing the optical fiber cord, pull the connector out slowly while pressing the lock release tab.

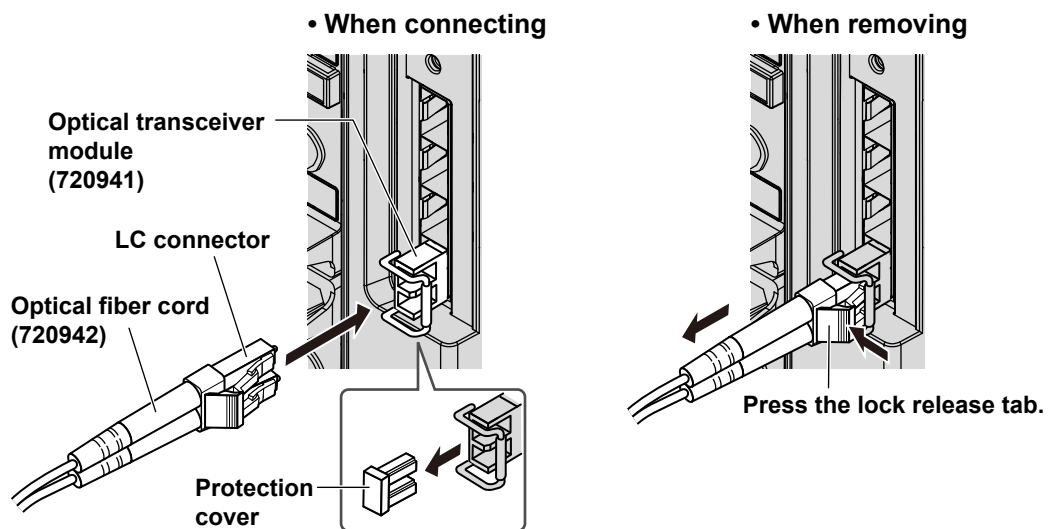

Safety Precautions for Laser Products

When an optical transceiver module (SFP, SFP+) is installed in this instrument, the instrument is considered a class 1 laser product as defined by IEC/EN 60825-1 Safety of Laser Products-Part 1:Equipment Classification, and Requirements. In addition, this instrument complies with FDA performance standards for laser products except for deviations pursuant to Laser Notice No. 50, dated June 24, 2007.

IF CLASS 1 LASER PRODUCT MODULE IS AVAILABLE

クラス1レーザーモジュール実装時
 安裝Class 1激光模块时



Complies with 21 CFR 1040.10 and 1040.11
 except for deviations pursuant to Laser
 Notice No.50, dated June 24, 2007
 4-9-8 Myojin-cho, Hachioji-shi, Tokyo 192-8566, Japan

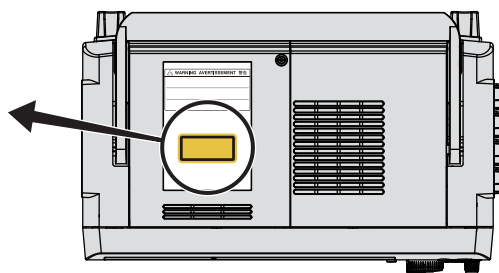

Laser Specifications

SFP Optical Transceiver Module (720941)

Class	Center Wavelength	Maximum Output Power*	Beam Divergence Angle (all angles @ 1/e ²)	Pulse Duration and Repetition Frequency	Supplier Code
1	850 nm	0.7 mW	20 deg	CW	FTLF8519P3BNL

* Under single fault conditions.

SFP+ Optical Transceiver Module (purchase an off-the-shelf product)

For the laser specifications, see the manual for the SFP+ optical transceiver module that you purchased.

If the instrument is used in a manner not specified in this manual, the protection provided by the instrument may be impaired. YOKOGAWA assumes no liability for the customer's failure to comply with these warnings and requirements.

4.1 Key and Jog Dial Operations

This section explains how to display and operate the setup menus using the keys and jog dial. You can also use the touch panel. For details, see section 4.2.

How to Display Setup Menus

To display a setup menu, press the key assigned to the setup menu you want to display. For the main features assigned to each key, see section 1.2, “Keys and Knobs.”

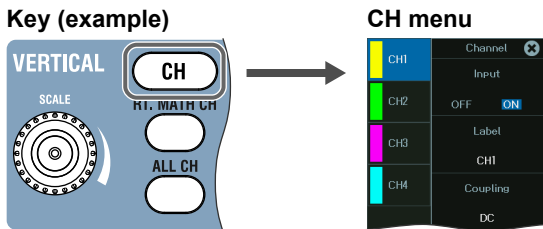

How to Display the Setup Menus That Are Written in Purple below the Keys

In the explanations in this manual, “SHIFT+key name (written in purple)” is used to indicate the following operation.

1. Press **SHIFT**. The SHIFT key illuminates to indicate that the keys are shifted. Now you can select the setup menus written in purple below the keys.
2. Press the key that you want to display the setup menu of.

How to Operate Setup Menus

To select a setting in the first level of a setup menu, press the soft key immediately right of the setting. The operation after you press the soft key varies depending on the setting you select.

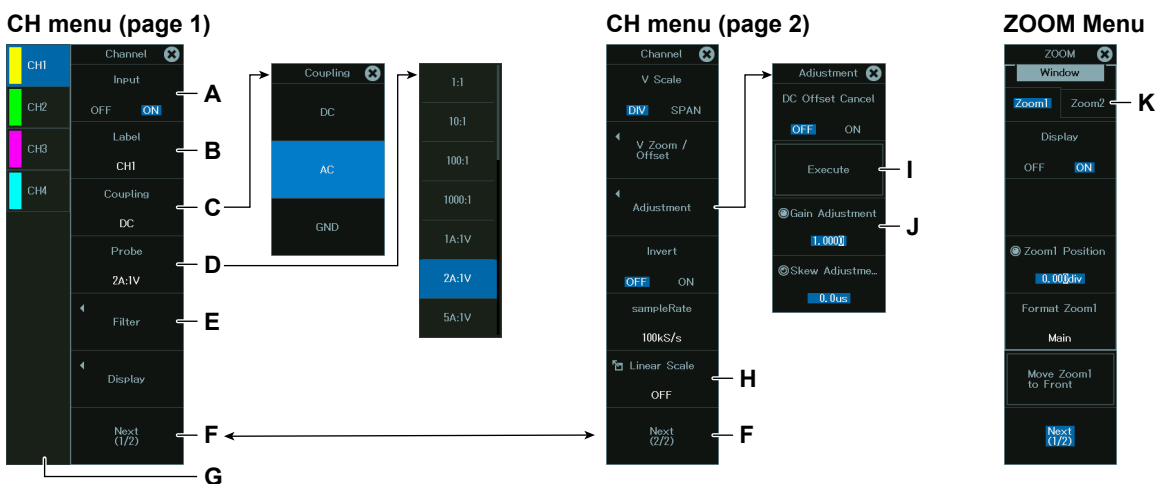

A:	The selected setting switches each time you press the soft key.
B:	Pressing the soft key displays a keyboard on the screen. For details on how to use the keyboard, see section 4.3, “Entering Values and Character Strings.”
C:	Press the soft key to display a selection menu for the setting. Press the soft key that corresponds to the appropriate setting.

4.1 Key and Jog Dial Operations

D:	Press the soft key to display a selection menu for the setting. Turn the jog dial or press the up and down arrow keys to select a setting, and press SET.
E:	A related setup menu appears when you press the soft key.
F:	When a setup menu has a second page, the page switches every time you press the soft key.
G:	Turn the jog dial or press the up and down arrow keys to select the channel you want to configure (CH menu and RT.MATH CH menu only).
H:	Pressing the soft key displays a setup dialog box. For details on how to use a setup dialog box, see “How to Use a Setup Dialog Box” on the next page.
I:	Press the soft key to execute the specified feature.
J:	Press the soft key to use the jog dial to configure this setting. Turn the jog dial or press the up and down arrow keys to set the value. For details on how to enter values, see section 4.3, “Entering Values and Character Strings.” When there are multiple settings, the setting that you are configuring changes every time you press the soft key.
K:	Selects which item to configure when configuring a feature that consists of two items that operate with different settings, such as the ZOOM1 and ZOOM2 features.

ESC Key Operation

If you press ESC when a setup menu or available options are displayed, the screen returns to the menu level above the current one. If you press ESC when the highest level menu is displayed, the setup menu disappears.

RESET Key Operations

If you press RESET when you are using the jog dial to set a value or select an item, the setting is reset to its default value (depending on the operating state of the instrument, the setting may not be reset).

SET Key Operations

The operation varies as indicated below depending on what you are setting.

- When there are two values to be set with the jog dial on a single setup menu
Press SET to switch the value that the jog dial adjusts.
- When selecting a selection menu item with the jog dial or arrow keys
Press SET to confirm the selected item.

How to Enter Values in Setup Dialog Boxes

1. Use the keys to display the appropriate setup dialog box.
2. Use the **jog dial** or the **arrow keys** to move the cursor to the setting that you want to set. The selected setting is enclosed in a blue frame.
3. Press **SET**. The operation varies as indicated below depending on what you are setting.
 - A check box is selected or cleared.
 - A selection menu appears.
 - A numeric setup menu appears.
 - On and off are toggled.
 - The setting is applied on a confirmation screen.
4. To clear the setup dialog box, press **ESC**.

Example of an FFT computation setup dialog box

The screenshot shows the 'FFT Math Setup' dialog box with two identical sections for 'Window1' and 'Window2'. Each section has a 'Start Point' of '-5.00div', 'Points' set to '1k', and 'Window' set to 'Hanning'. Below these are two tables of FFT parameters (FFTx, Mode, Type, Sub Type, Source1, Source2).

Annotations include:

- A blue frame around the 'Window1' checkbox with the text: "The selected item (enclosed in a blue frame)".
- A callout to the 'Start Point' field showing '-5.00div' with the text: "A value setup menu appears. Turn the jog dial or press the up and down arrow keys to select a value, and press SET."
- A callout to the 'Points' dropdown menu showing a list of values (1k, 2k, 5k, 10k, 20k, 50k, 100k) with the text: "A value selection menu is displayed. Turn the jog dial or press the up and down arrow keys to select a setting, and press SET."
- A callout to the 'Mode' column of the FFT tables with the text: "Each time you press SET, the setting toggles between ON and OFF."
- A callout to the 'Window1' checkbox with the text: "The check box state switches each time you press the SET key."

Example of an initialization confirmation screen

The screenshot shows a 'Confirm to Execute' dialog box with the text 'Initialize. Are you sure?' and two buttons: 'OK' and 'Cancel'. The 'Cancel' button is highlighted with a blue frame.

Annotation: "Press SET to execute the selected item."

4.2 Touch Panel Operations

This section explains the basic touch panel operations. It also explains how to display and use setup menus using the touch panel. You can also use the keys and jog dial. For details, see section 4.1.

Touch Panel Operations

The basic touch panel operations are described below.

Tap

Tap refers to the act of touching the screen lightly and letting go quickly.

It is used to display the top menu or pop-up menus, to select settings on a setup menu or dialog box, and to use the numeric keypad or keyboard.



Hold Down

Hold down refers to the act of touching the screen for a few seconds and letting go.

It is used to display a pop-up menu.



Drag

Drag refers to the act of pressing your finger against the screen and moving your finger.

It is used to scroll displayed settings and to select and move items, such as waveforms, cursor, and zoom box.

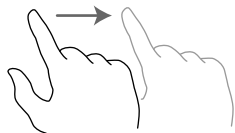

Pinch Out and Pinch In

Pinch out refers to the act of pressing two fingers against the screen and spreading them apart. Pinch in refers to the act of pressing two fingers against the screen and drawing them together.

It is used to zoom in on or out of waveforms. Pinch out to zoom in and pinch in to zoom out.

When you pinch in or out horizontally,  is displayed allowing you to zoom normally (timewise).

When you pinch in or out vertically,  is displayed allowing you to zoom the target waveform vertically.

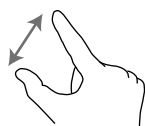

Pinch out

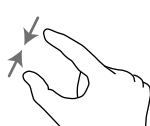

Pinch in



How to Display Setup Menus

1. Tap  in the upper left of the screen.
 - A top menu showing the instrument's front panel keys (excluding ESC, RESET, and SET) appears.
 - To close the top menu, tap anywhere outside the top menu area.
2. On the top menu, tap the setup menu item you want to display.
 - The same setup menu that appears when a key on the front panel is pressed is displayed, and the top menu disappears.
 - For the main features assigned to each key, see section 1.2, "Keys and Knobs."
3. To close a setup menu, tap  in the upper right of the setup menu.

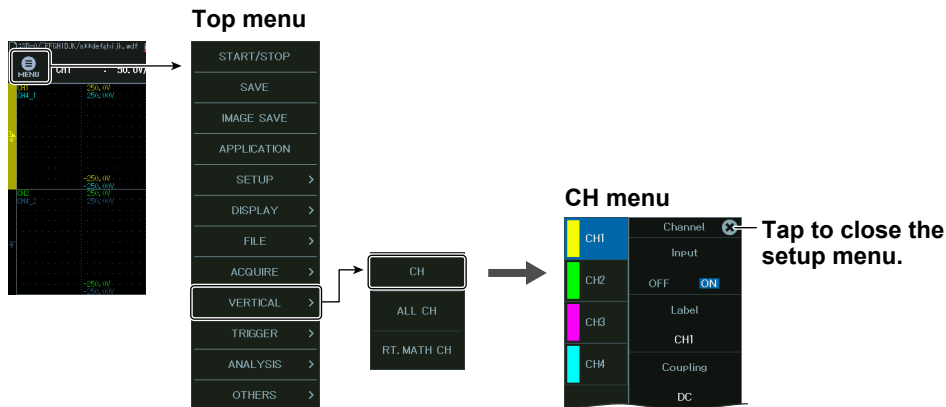

How to Operate Setup Menus

Tap the item you want to configure on the setup menu. The operation after tapping the item is the same as when you press a soft key. Refer to section 4.1, and use tapping instead of the operation to select settings. For settings that require a value to be entered, use the numeric keypad.

- **When you tap an item that requires a value to be entered**

A numeric keypad appears. For details on how to use the numeric keypad, see section 4.3.
- **When a setup dialog box is displayed**

A numeric keypad appears. For details on how to use the numeric keypad, see section 4.3.

Tap to select.

Tap to close the setup menu.

Tap to select.

When an item is hidden, drag over the items to scroll.

Tap each item to set options.

Tap to close the setup dialog box.

4.3 Entering Values and Strings

Entering Values

Using the Dedicated Knobs

You can use the following dedicated knobs to enter values directly.

- Vertical POSITION knob
- SCALE knob
- TIME/DIV knob
- ZOOM magnification knob (MAG)
- Zoom POSITION knob (for scrolling zoom waveforms)

Using the Jog Dial

Select the appropriate item using the soft keys, and change the value by turning the jog dial. This manual sometimes describes this operation simply as “using the jog dial.”

Using the Arrow Keys

Select the appropriate item using the soft keys, and change the value using the following:

- Up and down arrow keys:
Increases and decreases the value
- Left and right arrow keys:
Changes which digit to set

Using the Numeric keypad

Tapping the value you want to change displays a numeric keypad.

After you enter the value with the numeric keypad, tap **Enter** to confirm it.

You cannot use the jog dial or arrow keys while the numeric keypad is displayed.

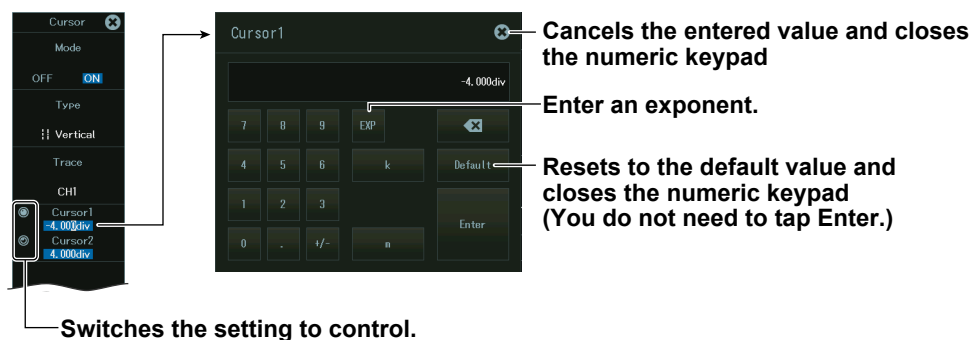

Note

Some items that you can set using the jog dial are reset to their default values when you press the RESET key.

Entering Character Strings

Use the keyboard that appears on the screen to enter character strings such as file names and comments.

Using the Touch Panel

1. With the keyboard displayed, tap the character you want to enter.
2. Repeat step 1 to enter all of the characters in the string.
3. Tap **Enter**. The character string is confirmed, and the keyboard disappears.

Using the Jog Dial, Arrow Keys, and SET Key

1. After bringing up the keyboard, use the **jog dial** to move the cursor to the character that you want to enter. You can also move the cursor using the up, down, left, and right **arrow** keys.
2. Press **SET** to enter the character.
3. Repeat steps 1 and 2 to enter all of the characters in the string.
4. Move the cursor to Enter and press **SET** to enter the character string and clear the keyboard.

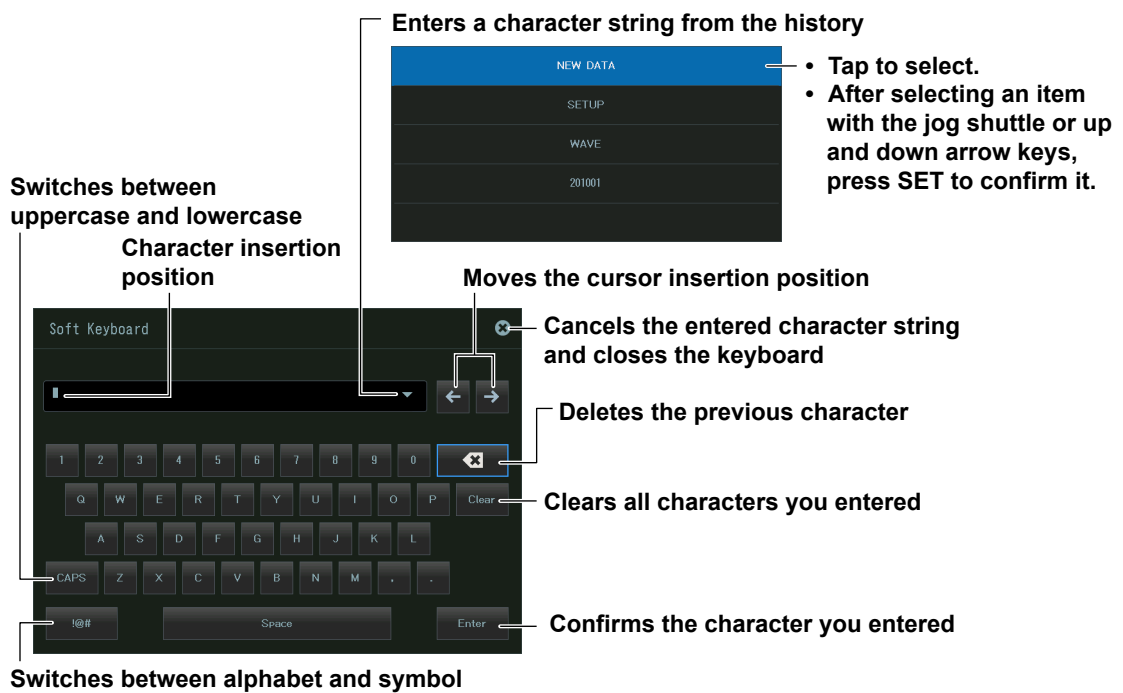

Note

- @ cannot be entered consecutively.
- File names are not case-sensitive. Comments are case-sensitive. The following file names cannot be used due to MS-DOS limitations:
AUX, CON, PRN, NUL, CLOCK, COM1 to COM9, and LPT1 to LPT9

4.4 Using USB Keyboards and Mouse Devices

Connecting and Using a USB Keyboard

You can connect a USB keyboard and use it to enter file names, comments, and other items.

Compatible Keyboards

You can use the following keyboards that conform to USB Human Interface Devices (HID) Class Ver. 1.1.

- When the USB keyboard language is English: 104-key keyboard
- When the USB keyboard language is Japanese: 109-key keyboard

Note

- Do not connect incompatible keyboards.
 - The operation of USB keyboards that have USB hubs or mouse connectors is not guaranteed.
 - For USB keyboards that have been tested for compatibility, contact your nearest YOKOGAWA dealer.
-

USB Ports for Peripherals

Connect a USB keyboard to one of the USB ports for peripherals on the left side panel.

Connection Procedure

Connect a USB keyboard directly to the instrument using a USB cable. You can connect or remove the USB cable regardless of whether the instrument's power switch is on or off (hot-plugging is supported). Connect the type A connector of the USB cable to the instrument, and connect the type B connector to the keyboard. When the power switch is on, the keyboard is detected and enabled approximately 6 seconds after it is connected.

Note

- Only connect a compatible USB keyboard, mouse, printer, or storage device to the USB port for peripherals.
 - Do not connect multiple keyboards. You can connect one keyboard, one mouse, and one printer.
 - Do not connect and disconnect multiple USB devices repetitively. Wait for at least 10 seconds after you connect or remove one USB device before you connect or remove another USB device.
 - Do not remove USB cables during the time from when this instrument is turned on until key operation becomes available (approximately 20 seconds).
-

Using a USB Keyboard

Entering File Names, Comments, and Other Items

When a keyboard is displayed on the screen, you can enter file names, comments, and other items using the USB keyboard.

Japanese Input

You can use a Japanese keyboard (109-key keyboard) to enter Japanese characters.

Connecting and Using a USB Mouse

You can connect a USB mouse to perform the same operations that you can perform by using the instrument's keys or tapping the instrument's touch panel.

USB Ports for Peripherals

Connect a USB mouse to one of the USB ports for peripherals on the left panel of the instrument.

Compatible USB Mouse Devices

You can use mouse devices (with wheels) that are compliant with USB HID Class Version 1.1.

Note

- For USB mouse devices that have been tested for compatibility, contact your nearest YOKOGAWA dealer.
- Some settings cannot be configured by a mouse without a wheel.

Connection Procedure

To connect a USB mouse to the instrument, use one of the USB ports for peripherals. You can connect or disconnect the USB mouse at any time regardless of whether the instrument is on or off (hot-plugging is supported). When the power switch is on, the mouse is detected approximately 6 seconds after it is connected, and the mouse pointer (☞) appears.

Note

- Only connect a compatible USB keyboard, mouse, printer, or storage device to the USB port for peripherals.
- Even though there are two USB ports for peripherals, do not connect two mouse devices to the instrument.

Using a USB Mouse

Click

Click on the screen. This is the same as tapping the instrument's touch panel.

Right-click

Right-click is invalid. Clicking the right button produces no effect.

Rotating the Mouse Wheel

When a scroll bar is displayed on the right side in the list of options or the file list, turn the mouse wheel with the pointer on the list. You can scroll the list in the same way as when you drag your finger on the instrument's touch panel.

4.5 Synchronizing the Clock

This section explains how to set the instrument's clock, which is used to generate timestamps for measured data and files. The instrument is factory shipped with a given date and time. You must set the clock before you start measurements.

UTILITY System Config Menu

1. Press **UTILITY**. The UTILITY menu appears.
You can also tap  at the upper left of the screen to display the main menu, and tap **OTHERS** and then **UTILITY** to display the UTILITY menu.
2. Tap **System Config** and then **Date/Time**, or press the soft keys. The following screen appears.

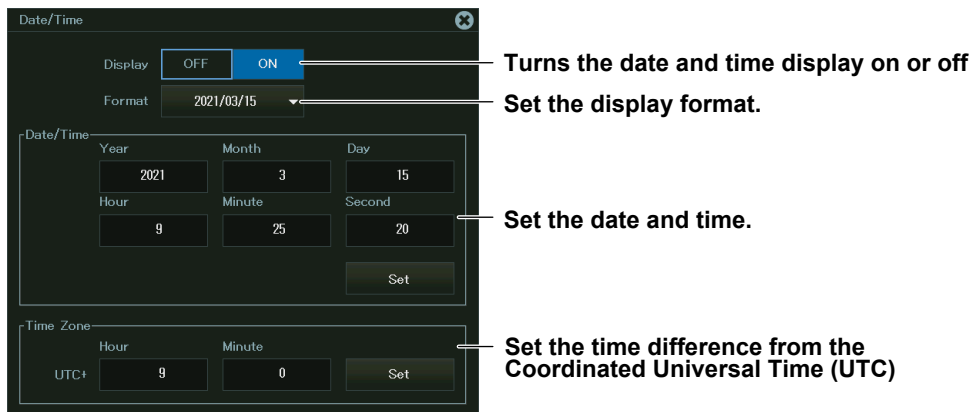

Setting the Display Format

You can display the date in one of the following formats.

- 2020/09/30 (year/numeric month/day)
- 30/09/2020 (day/numeric month/year)
- 30-Sep-20 (day-English abbreviation of the month-last two digits of the year)
- 30 Sep 2020 (day month (English abbreviation) year)

Setting the Time Difference (Time Zone) from the Coordinated Universal Time (UTC)

Set the time difference between the region where you are using the instrument and the UTC. This time difference is used when the clock is set using SNTP or when the time synchronization is set to IEEE1588 in master mode.

Selectable range: -12 hours 00 minutes to 14 hours 59 minutes

For example, Japan standard time is ahead of the UTC by 9 hours. In this case, set Time Hour to 9 and Minute to 00.

Checking the Time Difference from the Coordinated Universal Time (UTC)

Check using either of the following methods.

- Check the Date, Time, Language, and Regional Options on your PC.
- Check the website at the following URL: <http://www.worldtimeserver.com/>

Note

- This instrument does not support Daylight Saving Time. To set the Daylight Savings Time, reset the time difference from Greenwich Mean Time.
 - Date and time settings are backed up using an internal lithium battery. They are retained even if the power is turned off.
 - This instrument has leap-year information.
-

4.6 Initializing Settings

You can reset the instrument settings to their factory default values. This feature is useful when you want to cancel all the settings that you have entered or when you want to redo measurement from scratch.

SETUP Menu

1. Press **SETUP**. The SETUP menu appears.
You can also tap  at the upper left of the screen to display the main menu, and tap **SETUP** and then **SETUP** to display the SETUP menu.
2. Tap **Initialize** and then tap **OK** on the confirmation screen.
To cancel initialization, tap **Cancel** on the confirmation screen.

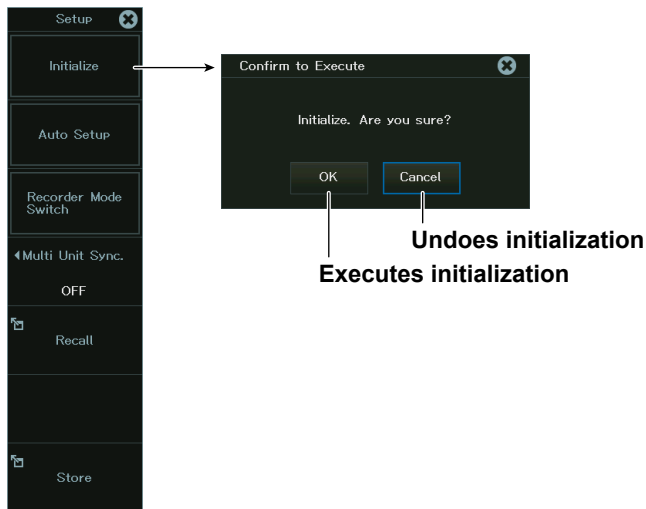

Settings That Cannot Be Reset to Their Factory Default Values

- Date and time settings
- Communication settings
- Language settings
- Start mode settings
- Operation mode (Scope mode or Recorder mode) settings
- Application menu's favorites
- Environment settings

Resetting All Settings to Their Factory Default Values

While holding down **RESET**, turn the power switch on. All settings are reset to their factory default values except the date and time settings (the display on/off setting will be reset) and the setup data stored in internal memory.

Note

This operation cannot be undone.

4.7 Switching the Operation Mode

This section explains how to switch the operation mode used in measurements. There are two operation modes: Scope and Recorder.

SETUP Menu

1. Press **SETUP**. The SETUP menu appears.
You can also tap  at the upper left of the screen to display the main menu, and tap **SETUP** and then **SETUP** to display the SETUP menu.
2. Tap **Recorder Mode Switch** or **Scope Mode Switch**, and then tap **OK** on the confirmation screen.

To cancel operation mode switching, tap **Cancel** on the confirmation screen.

• To switch to Recorder mode

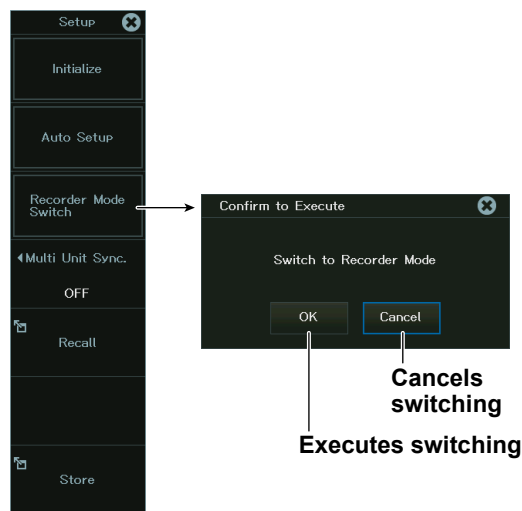

• To switch to Scope mode

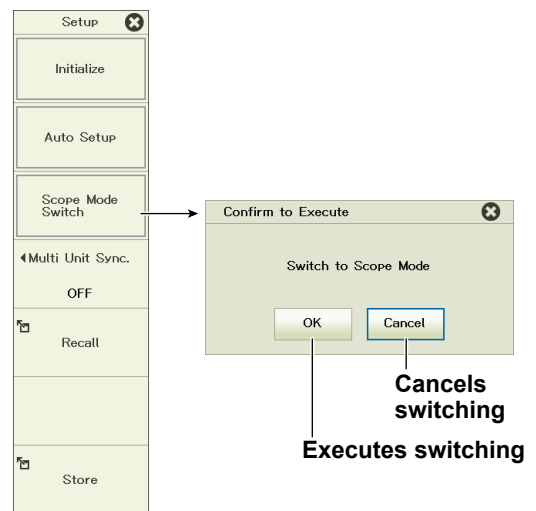

4.8 Performing Auto Setup

The auto setup feature automatically sets the V/div, Time/div, trigger level, and other settings to the most suitable values for the input signals.

SETUP Menu

1. Press **SETUP**. The SETUP menu appears.
You can also tap  at the upper left of the screen to display the main menu, and tap **SETUP** and then **SETUP** to display the SETUP menu.
2. Tap **Auto Setup** and then tap **OK** on the confirmation screen.
 - To cancel auto setup, tap **Cancel** on the confirmation screen.
 - In Scope mode, waveform acquisition starts after the auto setup execution.

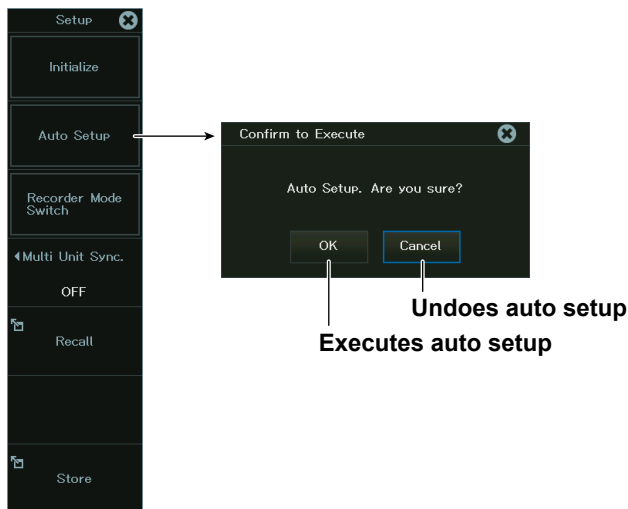

Center Position after the Execution of Auto Setup

The center position after you execute auto setup will be 0 V.

Applicable Modules

Auto setup is performed on the following modules.

720256 (4CH 10M16), 701250 (HS10M12), 720250 (HS10M12), 701251 (HS1M16), 701255 (NONISO_10M12), 720268 (HV (AAF, RMS)), 701261 (UNIVERSAL), 701262 (UNIVERSAL (AAF)), 701275 (ACCL/VOLT), 720212 (HS200M14), 720211 (HS100M12), 720254 (4CH 1M16)

Target Channels

Auto setup is performed on all channels except logic channels.

Logic waveforms are displayed with the same settings as before you executed auto setup.

Waveforms Displayed before the Execution of Auto Setup

When you perform auto setup, the data in the acquisition memory is overwritten, and the waveforms that were displayed before you executed auto setup are cleared.

Signals That Auto Setup Can Be Applied To

Frequency: Approx. 50 Hz or higher

Absolute input voltage: Signals whose maximum value is at least approx. 20 mV (at 1:1 setting)

Type: Simple, repeating signals

Note

The auto setup feature may not work properly for signals that include a DC component or high-frequency components.

Settings after the Execution of Auto Setup

Waveform Acquisition and Display Settings

Time/div (Scope mode)	The waveform with the shortest period out of the waveforms affected by auto setup is used to set T/div. T/div is set to the value at which 1.6 to 4 periods of the waveform can be displayed.
START/STOP	START
Acquisition mode	Normal
Acquisition count (Scope mode)	Infinite
Record length (Scope mode)	10 k
Time base	Int.
SSD Recording (Scope mode)	Off
Dual capture (Scope mode)	Off
Accumulation	Off

Vertical Axis Settings

V/Div, V Range	A value that causes the absolute values of the input waveform to be between 1.6 and 4.5 div
Coupling	DC
Bandwidth limit	Full
Input on/off	Channels whose absolute input voltage values reach or exceed 20 mV (1:1) are displayed (except for Scan). The displays of modules that are not affected by auto setup do not change.
Vertical scale (Scope mode)	DIV
Position (Scope mode)	0.00 div
Vertical zoom (Scope mode)	×1

Trigger settings (Scope mode)

Trigger mode	Auto
Trigger type	SIMPLE
Trigger source	The channel with the longest period out of the channels whose amplitude is 1 div or greater
Trigger level/slope	The level between the maximum and minimum values/ rising
Hysteresis	Low
Hold-off	0.0 ns
Trigger position	50 %
Trigger delay	0.0 μs

Computation Settings

Math	Off
------	-----

The values of settings not listed here do not change.

4.9 Calibrating the Instrument

CAL Menu

1. Press **SHIFT+SETUP (CAL)**. The CAL menu appears.
You can also tap  at the upper left of the screen to display the main menu, and tap **SETUP** and then **CAL** to display the CAL menu.
2. Tap **Execute Calibration**.

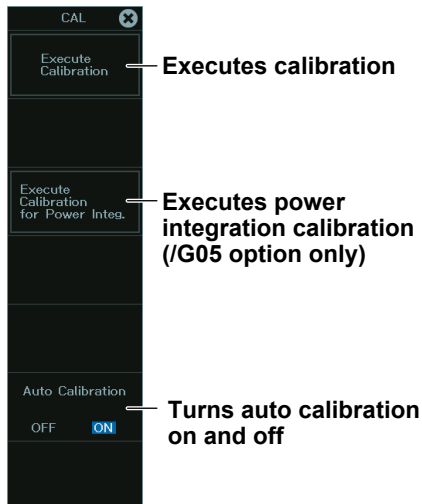

Calibration

The following items are calibrated. Execute calibration when to make accurate measurements.

- Vertical axis ground level and gain

Note

Calibration is automatically performed for the settings above when the power switch is turned on.

Notes about Calibration

- Allow the instrument to warm up for at least 30 minutes before you execute calibration. If you execute calibration immediately after power-on, the calibrated values may drift due to temperature changes or other environmental changes.
- Execute calibration in a stable temperature environment ranging from 5 to 40 °C (23 ±5 °C recommended).
- Do not apply signals when calibrating. Calibration may not be executed properly when input signals are being applied to the instrument.

Auto Calibration (Auto Cal)

Auto calibration is executed the first time you start signal acquisition after changing the Time/div setting if any of the time periods listed below has elapsed since the power was turned on.

- 3 minutes
- 10 minutes
- 30 minutes
- 1 hour and every 1 hour thereafter

If calibration is executed while signals are being applied to the instrument, we recommend that you stop signal application and recalibrate the instrument.

4.10 Starting and Stopping Waveform Acquisition

Starting and Stopping Waveform Acquisition

Press **START/STOP**. Waveform acquisition starts or stops.

The key is illuminated while the instrument is acquiring waveforms.

Waveform Acquisition and Indicators

- When the START/STOP key is illuminated, the instrument is acquiring waveforms. “Running” appears in the lower left of the screen.
- When the START/STOP key is not illuminated, waveform acquisition is stopped. “Stopped” appears in the lower left of the screen.

Instrument Operation When the Acquisition Mode Is Set to Averaging

- Averaging stops when you stop waveform acquisition.
- If you restart waveform acquisition again, averaging starts from the beginning.

START and STOP Operations during Accumulation

- Accumulation stops when you stop acquisition.
- If you restart waveform acquisition, past waveforms are cleared, and accumulation starts over.

Note

You can use the snapshot feature to retain the displayed waveform on the screen. This feature allows you to retain the waveform that you have taken a snapshot of on the screen while the instrument continues signal acquisition.

4.11 Displaying Help



Displaying Help

Press **HELP** ()

You can also tap  at the upper left of the screen to display the main menu, and tap **OTHERS** and then **HELP** to display the HELP menu.

The table of contents and index appear in the left frame, and text appears in the right frame.

Switching between Frames

To switch to the frame that you want to control, tap the frame, or use the left and right (, ) arrow keys.

Moving Cursors and Scrolling

To scroll through the screen or to move the cursor in the table of contents or index, drag or turn the **jog dial**.

Moving to the Link Destination

To move to a description that relates to blue text or to move from the table of contents or index to the corresponding description, tap the appropriate blue text or item, or move the cursor to the appropriate blue text or item using the **jog dial** or arrow keys, and then press **SET**.



Displaying Panel Key Descriptions

With the help file displayed, press a panel key to display an explanation of it.

Returning to the Previous Screen

To return to the previous screen, tap  on the screen, or press **RESET**.

Hiding the Help File

Tap  at the upper right of the screen, or press **HELP** () or **ESC** when help is displayed.

5.1 External Trigger Input (TRIGGER IN)



CAUTION

Only apply signals that meet the specifications below. Excessive voltage or the like may damage the instrument.

French



ATTENTION

Les signaux ne correspondant pas aux spécifications risquent d'endommager cet instrument, à cause de facteurs tels qu'une tension excessive.

External Trigger Input Terminal



This terminal is used when an external signal is used as the trigger source.

Item	Specifications
Connector type	BNC
Input level	TTL (0 to 5 V)
Minimum pulse width	100 ns
Detected edge	Rising or falling

Circuit Diagram and Timing Chart for External Trigger Input

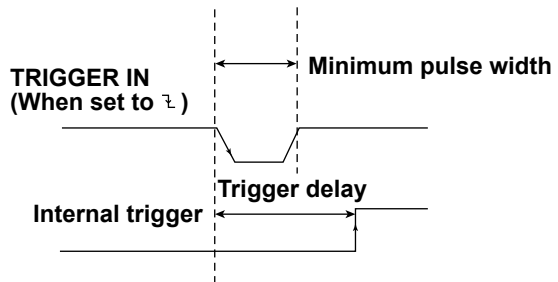
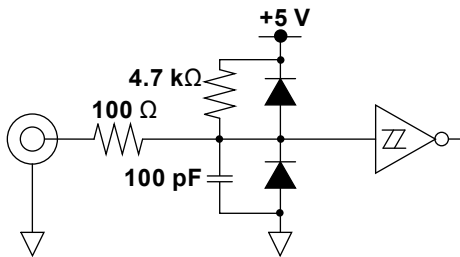

5.2 Trigger Output (TRIGGER OUT)



CAUTION

Do not short the TRIGGER OUT terminal or apply external voltage to it. If you do, the instrument may malfunction.

French



ATTENTION

Ne pas mettre la borne TRIGGER OUT en court-circuit et ne pas y appliquer une tension externe. Si vous le faites, l'instrument pourrait mal fonctionner.

Trigger Output Terminal

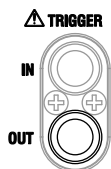

The following CMOS level signals can be transmitted.

Trigger Output (Normal)

When the output format is set to normal, the terminal transmits a falling signal when a trigger occurs. The signal level is normally high but goes low when a trigger occurs.

Trigger Output (Pulse)

When the output format is set to pulse, the terminal transmits a pulse signal when a trigger occurs. You can set the pulse width.

Specifications

Item	Specifications	
Connector type	BNC	
Output level	5 V CMOS	
Output delay time	(1.8 μ s to 4.5 μ s) + 1 sample (typical value) Applies to 1 MS/s or faster modules. Depends on the installed module.* However, during multi-unit synchronization (/C50 option), the delay is 5.2 μ s + 1 sample (typical value) (can only be output from the main unit).	
Output type		
• Normal	Logic	Falls when a trigger occurs and rises when a signal acquisition is completed
	Output hold time	100 ns or more
• Pulse	Logic	Transmits a pulse when a trigger occurs
	Pulse width	1 ms, 50 ms, 100 ms, 500 ms

* The trigger output signal delay varies depending on the installed module as follows: When a combination of these modules are installed, the delay time is that of the module with the greatest delay time.

Module	Trigger Output Delay (typical value)
720211	1.8 μ s + 1 sample
720212	2.5 μ s + 1 sample
720256	2.2 μ s + 1 sample
701250	2.1 μ s + 1 sample
720250	
701255	
720254	4.5 μ s + 1 sample
701251	
720268	

Circuit Diagram and Timing Chart for Trigger Out

TRIGGER OUT

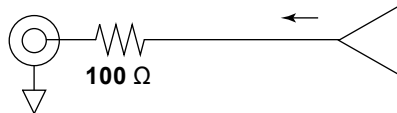

• Normal mode

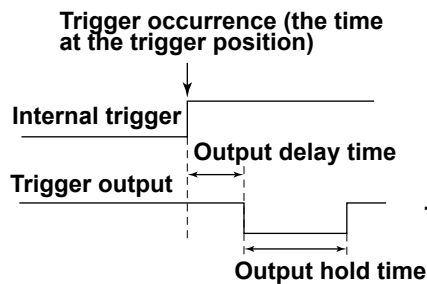

• Pulse mode

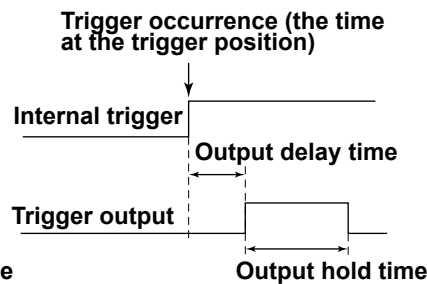

Low Level and High Level Hold Times (In normal mode)

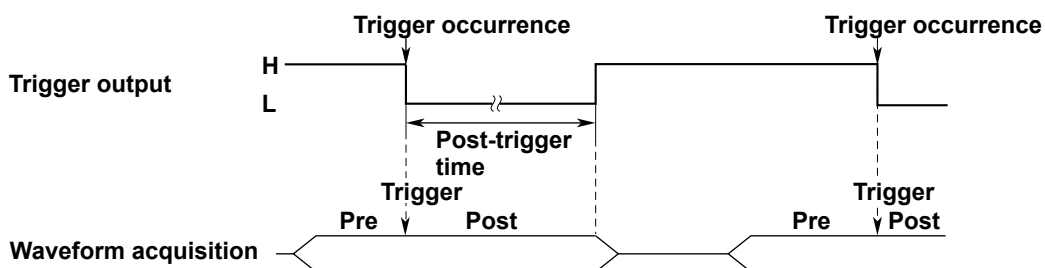

5.3 External Clock Input (EXT CLK IN)



CAUTION

Only apply signals that meet the specifications below. Excessive voltage or the like may damage the instrument.

French



ATTENTION

Les signaux ne correspondant pas aux spécifications risquent d'endommager cet instrument, à cause de facteurs tels qu'une tension excessive.

External Clock Input Terminal



Use this terminal to operate the instrument using an external clock signal.

Item	Specifications
Connector type	BNC
Input level	TTL (0 to 5 V)
Maximum input frequency	9.5 MHz
	100 kHz (for envelope)
Minimum pulse width	50 ns
Detected edge	Rising

Circuit Diagram for External Clock Input

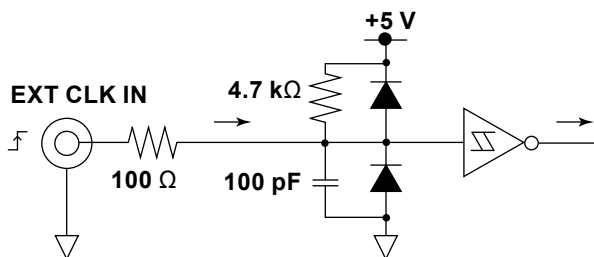

5.4 Sample Clock Output (CLKO)



CAUTION

Do not short the CLKO terminal or apply external voltage to it. If you do, the instrument may malfunction.

French



ATTENTION

Ne pas court-circuiter la borne CLKO et ne pas appliquer de tension de sortie. Si vous le faites, l'instrument pourrait mal fonctionner.

Sample Clock Output (CLKO)

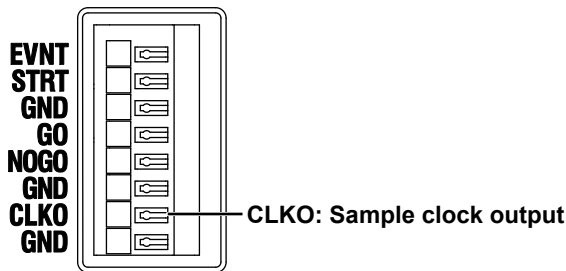

Periodic pulse signals can be output according to the following settings. You can set the pulse rate.

- OFF: Pulse signals are not output.
- Acquisition: Pulse signals are output only while the instrument is acquiring waveforms.
- Free run: Pulse signals are output constantly.

Item	Specifications
Connector type	Screwless terminal block
Output level	5 V CMOS
Output operation	Outputs a clock signal at the specify frequency
Frequency range	5 Hz to 200 kHz (1-2-5 steps)

Circuit Diagram of Sample Clock Output

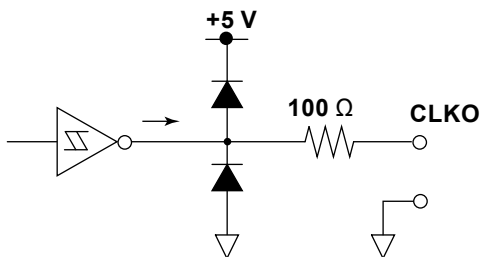

Connecting a Wire to the Terminal

What to Prepare

Wiring

- Remove 9 mm to 10 mm of the insulation from the end of the wire.
- Wire: Solid wire or thin stranded wire, AWG size: 22 to 28

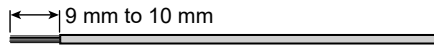

Connecting Wires to the Terminal Block

First, turn off the instrument. Next, make sure that the other end of the wire that you are connecting to the terminal block is not connected to a device, or make sure that the device that you are going to connect to is turned off.

1. Press the button next to the wire insertion hole with a flat-blade screwdriver or the like. Insert firmly to open the wire insertion hole.
2. Insert the wire that you prepared into the wire insertion hole. Insert the wire until it reaches the back of the wire insertion hole.
3. Pull lightly on the wire to make sure that it doesn't come out.

When you finish connecting the wire, turn on the instrument and the other device.

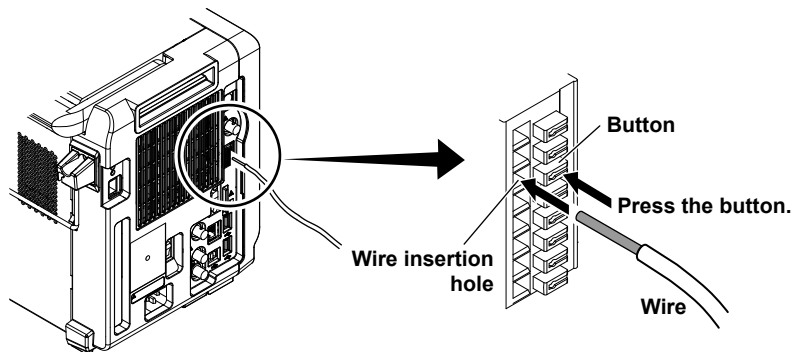

5.5 GO/NO-GO Determination Output (GO/NOGO)



CAUTION

- Do not apply external voltage to the NO-GO or GO output terminal. If you do, the instrument may malfunction.
- When connecting the GO/NO-GO determination signal output to another device, do not connect the wrong signal terminal. Doing so may damage this instrument or the connected instrument.

French



ATTENTION

- Ne pas appliquer de tension externe à la borne de sortie NO-GO ou GO. Si vous le faites, l'instrument pourrait mal fonctionner.
- Lors de la connexion de la sortie de signal de détermination GO/NO-GO à un autre appareil, veiller à ne pas connecter la mauvaise borne de signal. Cela pourrait endommager cet instrument ou l'instrument connecté.

GO/NO-GO Determination Output (GO/NOGO)

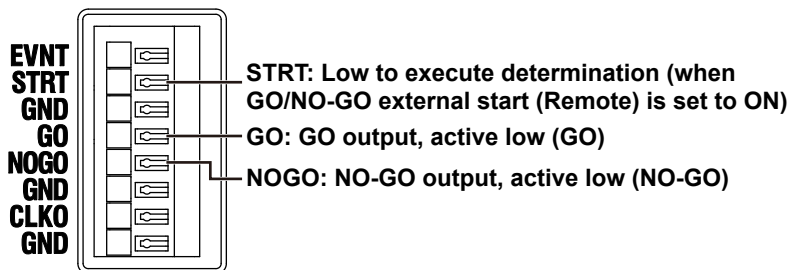

GO/NO-GO determination results can be output from the instrument's GO/NO-GO output terminal. GO/NO-GO determination can also be performed in sync with a signal received through the START terminal.

Item	Specifications
Connector type	Screwless terminal block
Output level	5 V CMOS

Input signal

START (negative logic)

Use this signal to perform GO/NO-GO determination by synchronizing to an external input signal. The signal is only valid when on the GO/NO-GO menu, Remote is set to ON. If Remote is set to OFF, GO/NO-GO determination is performed regardless of the external signal input (the GO/ NOGO determination result is output).

Signal Input Circuit

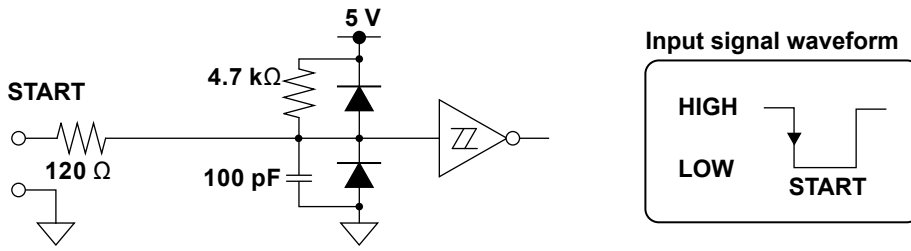

Output Signal

NOGO (Negative logic)

When the determination result is NO-GO (fail), the output signal level temporarily changes from high (H) to low (L).

GO (negative logic)

When the determination result is GO, the output signal level temporarily changes from high (H) to low (L).

Signal Output Circuit

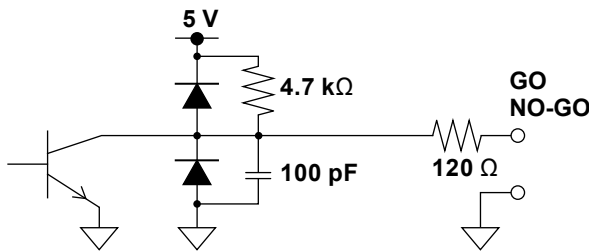

START Input and GO/NO-GO Output Timing

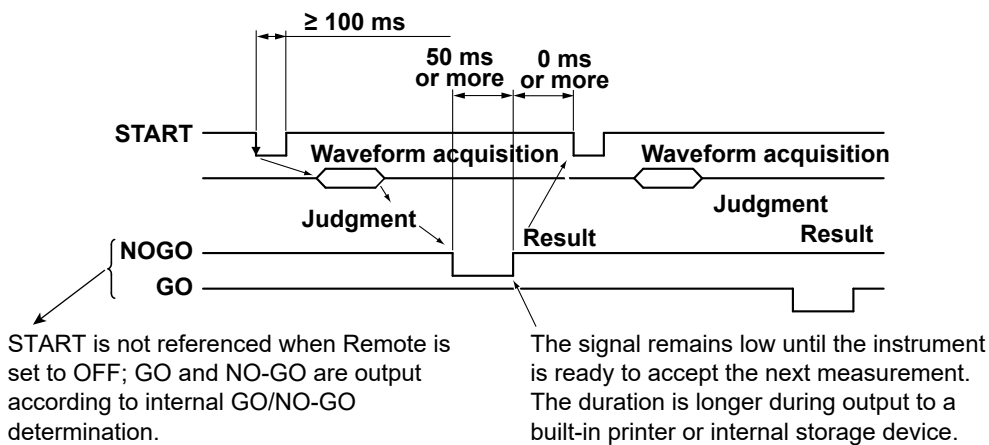

Connecting a Wire to the Terminal

For instruction on how to connect a wire to the terminal, see page 5-6.

5.6 External Start/Stop/Event Input (START/ EVENT)



CAUTION

Only apply signals that meet the specifications below. Excessive voltage or the like may damage the instrument.

French



ATTENTION

Les signaux ne correspondant pas aux spécifications risquent d'endommager cet instrument, à cause de facteurs tels qu'une tension excessive.

External Start/Stop/Event Input (START/ EVENT)

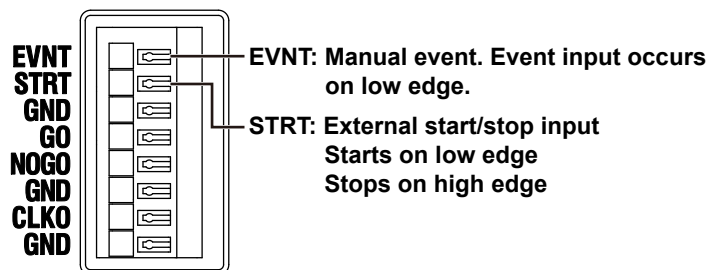

The START terminal can be used to externally control the starting and stopping of the instrument.

The EVENT terminal can receive manual event signals.

The START terminal is the same terminal as the external signal input terminal for GO/NO-GO determination. This terminal is used as an external start/stop input when the GO/NO-GO determination output function is not used (when on the GO/NO-GO menu, Mode is set to OFF).

Item	Specifications
Connector type	Screwless terminal block
Input level	TTL (0 to 5 V) or contact input

Circuit Diagram for External Start/Stop/Event Input

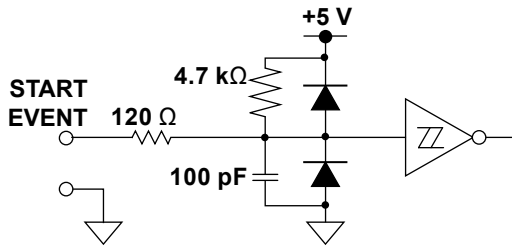

Contact input is possible

- For start/stop input Close to start, open to stop
- For event input Close to input event

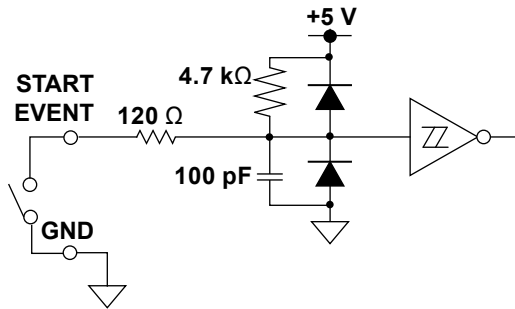

Input signal waveform

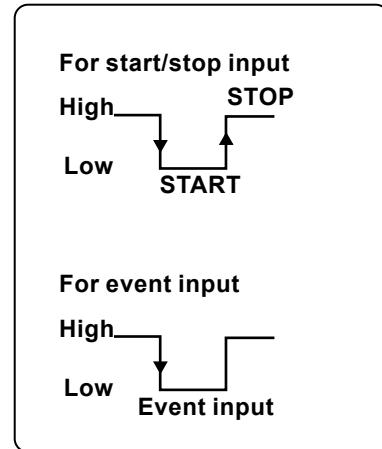

Note

- Low and high edges are used to detect starts and stops.
- You can select whether to enable high edges (stops) in the external start/stop signal or disable. For details on the setup, see section 23.6, “Configuring the Environment Settings,” in the user’s manual.

Connecting a Wire to the Terminal

For instruction on how to connect a wire to the terminal, see page 5-6.

5.7 Video Signal Output (VIDEO OUT (XGA))



CAUTION

- Connect the cable after turning off this instrument and the monitor.
- Do not short the VIDEO OUT terminal or apply external voltage to it. If you do, the instrument may malfunction.

French



ATTENTION

- Connecter le câble après avoir mis cet instrument et le moniteur hors tension.
- Ne pas court-circuiter la borne VIDEO OUT et ne pas appliquer de tension de sortie. Si vous le faites, l'instrument pourrait mal fonctionner.

Video Signal Output Terminal

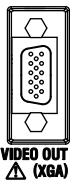

You can use video signal output to display the instrument's screen on a monitor. Any multisync monitor that supports XGA can be connected.

Item	Specifications
Connector type	D-sub 15 pin, receptacle
Output type	Analog RGB
Output resolution	XGA-compliant output, 1024 × 768 dots Approx. 60-Hz Vsync (66-MHz dot clock frequency)

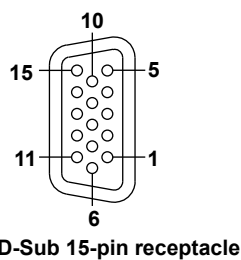

Pin No.	Signal	Specifications
1	Red	0.7 V _{P-P}
2	Green	0.7 V _{P-P}
3	Blue	0.7 V _{P-P}
4	—	
5	—	
6	GND	
7	GND	
8	GND	
9	—	
10	GND	
11	—	
12	—	
13	Horizontal sync signal	Approx. 36.4 kHz, TTL positive logic signal
14	Vertical sync signal	Approx. 60 Hz, TTL positive logic
15	—	

Connecting to a Monitor

1. Turn off this instrument and the monitor.
2. Connect this instrument and the monitor using an analog RGB cable.
3. Turn on this instrument and the monitor.

5.8 IRIG Signal Input (IRIG)/(C35 option)



CAUTION

Only apply signals that meet the specifications below. Excessive voltage or the like may damage the instrument.

French



ATTENTION

Les signaux ne correspondant pas aux spécifications risquent d'endommager cet instrument, à cause de facteurs tels qu'une tension excessive.

IRIG Signal Input Terminal



You can use an IRIG (Inter Range Instrumentation Group) signal to set the time on the instrument.

Item	Specifications
Input connector	BNC
Number of input connectors	1
Compatible IRIG signals	A006, B006, A136, B126
Input impedance	50 Ω /5 k Ω switchable
Maximum input voltage	± 8 V
Function	Instrument clock synchronization Sample clock synchronization
Clock sync range	± 60 ppm
Post-sync accuracy	No drift from the input signal

5.9 GPS Signal Input (GPS)/(C35 option)

CAUTION

Only apply signals that meet the specifications below. Excessive voltage or the like may damage the instrument.

French

ATTENTION

Les signaux ne correspondant pas aux spécifications risquent d'endommager cet instrument, à cause de facteurs tels qu'une tension excessive.

GPS Signal Input Terminal



You can use a GPS (Global Positioning System) signal to set the time on the instrument.

Item	Specifications
Input connector	9-pin Mini DIN
Compatible GPS unit	720940 (optional accessory)
Function	Instrument clock synchronization Sample clock synchronization
Accuracy after synchronization*	±200 ns (typical value when locked to GPS signal)*

* The figure is based on results obtained when the GPS unit is installed in a location with good line of sight to GPS satellites. The accuracy may not be attained depending on the measurement location, the location of satellites when the measurement is taken, the weather, and influence caused by obstruction.

6.1 If a Problem Occurs

Faults and Corrective Actions

If a message appears on the screen, see the following pages for reference.

If servicing is necessary, or if the instrument does not operate properly even after you have attempted to deal with the problem according to the instructions in this section, contact your nearest YOKOGAWA dealer.

Problem	Probable Cause	Corrective Action	Reference Section
The instrument does not turn on.	Using a power supply outside the ratings.	Use a correct power supply.	3.4
Nothing is displayed.	The backlight is turned off.	Press any key.	23.4*
	The screen is displayed with inappropriate colors.	Turn the power off, and then turn the power on again while pressing RESET .	4.6
The display is odd.	The system is not operating properly.	Turn off the instrument and then turn it back on.	3.5
Channels and MATH waveforms whose displays are turned on do not appear on the screen.	The display group containing the waveforms that you want to display is not selected.	Press DISPLAY and then the Select Group soft key to select a display group (1 to 4).	2.1*, 5.1*
Keys do not work.	The instrument is in remote mode.	Press SHIFT+CLEAR TRACE to switch the instrument to local mode.	—
	The panel and keys are locked.	Press KEY PROTECT .	23.7*
	Other causes.	Perform a key test. If the test fails, servicing is required.	6.3
The touch panel does not work.	The touch panel feature is turned off.	Turn on the touch panel feature.	23.4*
	The instrument is in remote mode.	Press SHIFT+CLEAR TRACE to switch the instrument to local mode.	—
	The panel and keys are locked.	Press KEY PROTECT .	23.7*
Triggering does not work.	The trigger settings are not appropriate.	Set the trigger conditions correctly.	Chapter 4*
The measured values are not correct.	Insufficient warm-up.	Warm up the instrument for 30 minutes after turning on the power.	—
	The instrument has not been calibrated.	Calibrate the instrument.	4.9
	The probe's phase has not been corrected.	Perform phase correction properly.	3.7
	The probe attenuation is not correct.	Set an appropriate value.	2.1*
	Other causes.	Calibrate the instrument. If the measured values are still not correct, servicing is required.	4.9, 6.3
Cannot save to the specified storage device.	The storage device is not formatted.	Format the storage device.	19.3*
	The storage device is read-only.	Set the storage device so that it is not read-only.	—
	No more free space on the storage device.	Delete unneeded files or use another storage device.	19.10*

6.1 If a Problem Occurs

Unable to configure or control the instrument through the communication interface.	The instrument's IP address (in the case of a network connection) or serial number (in the case of a USB connection) is different from that referred to by the program.	Match the IP address or serial number used in the program to the actual IP address or serial number of the instrument.	Communication Interface User's Manual, IM DL950-17EN
	The interface is not used in a way that conforms to the electrical or mechanical specifications.	Use the interface in a way that conforms to the specifications.	

* User's Manual, IM DL950-02EN

6.2 Messages and Corrective Actions

Messages

Messages may appear on the screen during operation. This section describes the error messages and how to respond to them. You can display the messages in the language that you specify through the operations explained in section 23.3 in the User's Manual, IM DL950-02EN. If servicing is necessary to solve the problem indicated by a message, contact your nearest YOKOGAWA dealer.

In addition to the following error messages, there are also communications error messages. These messages are explained in the communication interface user's manual, IM DL950-17EN.

Information

Code	Message	Chapter or Section
51	Autosetup is running.	4.8
53	Initializing is in progress.	4.6
57	Automatic balancing is running...	2.5 ¹
58	Automatic balancing is complete.	2.5 ¹
59	Calibration is running...	4.9
61	Media format is running.	19.3 ¹
62	Media format is complete.	19.3 ¹
63	A strain module is installed. Carry out automatic balancing before use.	2.5 ¹
64	File access is aborted.	—
67	Key response time is more than 1 second. Push it more than 1 second.	23.6 ¹
70	Exit from GO/NO-GO mode.	Chapter 14 ¹
72	Completed action.	15.1 ¹
73	Aborted the search.	Chapter 8 ¹
74	Executed the search, but no record was found that matched the conditions.	Chapter 8 ¹
75	Executed the search, but no record was found that matched the pattern.	Chapter 8 ¹
76	Total length of sync cable is too long.	—
77	Aborted the statistical measurement.	Chapter 11 ¹
79	Averaging has been completed.	—
80	Input module configuration was changed. All settings have been initialized.	Chapter 2 ¹
81	This model does not have computation option installed.	13.4 ¹
82	This model does not have the SSD option installed.	3.5 ¹
83	Write to the EEPROM complete. Wrote module-specific information to the module.	—
84	All settings were initialized.	—
85	The instrument is set to remote mode by the communication control. Press the SHIFT + CLEAR TRACE key to change to local mode.	—
86	Push 'Zoom Mag' knob or 'Zoom Position' knob when change a target window.	7.1 ¹
87	Sensed the firmware version change. Will initialize.	—
88	Post processing of SSD Record. Wait a while.	—
89	Cannot display XY waveforms under these conditions. -Different sample rate between X & Y. -SSD Recording waves	—
90	Executed the Autosetup, but no effective channel was found.	—

6.2 Messages and Corrective Actions

Code	Message	Chapter or Section
91	Some signals were not loaded due to the following problems. Check the symbol file. -The Number of signals is too many. -"Value Type" is not supported. -"Bit Count" is too many.	—
92	Cannot display some zoom waves while in this condition.	—
93	Following sub channel was set to Off due to limit of memory capacity.	2.9, ¹ 2.10, ¹ 2.11 ¹
94	Executing abort process. It takes a few seconds.	8.1 ¹
95	Cannot set all sub-channels input to on due to limit of memory capacity.	2.9, ¹ 2.10, ¹ 2.11 ¹
96	The following option was installed. To activate the option, restart the DL950.	—
97	Offset cancel value was set to maximum value due to over the limit.	—
98	Automatic balancing and offset cancel is running...	2.12 ¹
99	Automatic balancing and offset cancel is complete.	2.12 ¹

1 User's Manual, IM DL950-02EN

File Errors

Code	Message	Chapter or Section
500	File access failure.	—
501	Invalid file name. The name contains prohibited characters, or file name is duplicated.	19.4 ¹
502	Pass name over maximum number of characters. Full pass name should under 255 characters.	19.4 ¹
504	Out of disk space.	19.10 ¹
505	File not found. Check the file.	19.10 ¹
506	Duplicate file or directory name. Change the name.	19.10 ¹
507	The file name is not set. Set the file name.	19.4 ¹
508	Save data not found. Check for presence of data and channel.	Chapter 19 ¹
510	Cannot load this file format. Files stored on other models cannot be loaded.	—
511	File is now being accessed. Execute after access is made.	—
512	Cannot be executed while running. Press the START/STOP key to stop acquisition.	—
513	The specified file cannot be loaded on this Firmware version or this model.	—
514	No ch is displayed. Turn ON the display of the appropriate channel.	Chapter 2 ¹
515	Reached the maximum file size that can be stored.	—
516	SSD overrun error. The operation is aborted.	—
517	Unknown file format.	Chapter 19 ¹
518	Writing prohibited in the media. Unlock write protection of the media.	—
519	Cannot save in this format at the current record length. Specify a range and save a section of the data. * Cannot create a file of size 2 GB or larger.	—
520	Media error.	—
521	Directory can not be deleted.	19.1 ¹
522	Cannot load these files on a network drive. The File which larger than 50 Mbyte. Copy the file to the local drive before loading it.	19.10, ¹ 20.5 ¹
529	The file type to be loaded does not match the extension. Check the file name.	Chapter 19 ¹
530	Assigned path does not exist. Check the network setting and configuration.	Chapter 20 ¹
531	Assigned file does not exist. Check the network setting and configuration.	Chapter 20 ¹
532	Assigned path does not exist. Check the network setting and configuration.	Chapter 20 ¹
533	Writing prohibited in this file.	—
534	An error occurred while network access. Confirm network conditions.	Chapter 20 ¹
535	Current path is not suitable. Set other path while use action on trigger.	—
536	Destination path is same as source path, or sub folder of source path.	—
538	Module configuration is not matched, so it couldn't loaded. Configuration of saved data can see by File property.	Chapter 19, ¹ Chapter 19 ²

6.2 Messages and Corrective Actions

Code	Message	Chapter or Section
539	Module configuration is not matched, so it couldn't loaded. Configuration of saved data can see by File property.	Chapter 19, ¹ Chapter 19 ²
541	Cannot detect the medium. Check the presence of the medium.	—
542	Cannot start SSD recording while disk space shortage.	—
544	Cannot file access, Initialize, and autoseup while measure is in progress. Wait measure end, or OFF it.	11.1 ¹
545	Data read error.	—
546	Cannot save when subchannel condition was changed. Restore subchannel condition.	Chapter 2 ¹
549	Cannot load the data which saved with a freerun mode.	—
550	The number of the files in the root of the SSD exceeds 512 of the upper limit or approaches. Plaese delete the unnecessary files or make a folder, and save files in the folder.	19.2, ¹ 19.10 ¹
552	No items to save are set. Check the data type to save.	Chapter 19 ¹
554	File loading completed normally. However, because the loaded module is different from the current module configuration, the following channel settings and data are not loaded.	—
558	File processing has been aborted.	—

¹ User's Manual, IM DL950-02EN

² Features Guide, IM DL950-01EN

Printer Errors

Code	Message	Chapter or Section
576	Printer error.	—

Network Errors

Code	Message	Chapter or Section
600	Unable to connect to the server. Check the network settings and configuration.	Chapter 20 ¹
601	Has not connect with ftp server yet. Confirm the network settings and connection.	Chapter 20 ¹
602	This ftp function in not supported.	—
603	FTP Error: Client Handle Confirm the network settings and connection.	Chapter 20 ¹
604	Cannot send data to a network printer. Confirm the network settings and connection.	Chapter 20 ¹
605	Cannot send a mail. Confirm the network settings and connection.	Chapter 20 ¹
608	Failed to acquire time from SNTP server. Confirm the network settings and connection.	Chapter 20 ¹

1 User's Manual, IM DL950-02EN

Execution Errors (650 to 799)

Code	Message	Chapter or Section
650	Data is invalid.	—
651	The option is not equipped, so it cannot execute.	—
653	Can not be executed while running. Press START/STOP key to stop acquisition.	—
655	Cannot change the mode of realtime analysis, while the cursor and measure are running.	Chapter 17 ¹
657	SSD recording is valid when the sampling rate is slower than the values shown below. 1CH : 2MS/s, 2 to 3CH : 1MS/s, 4 to 6CH : 500kS/s, 7 to 16CH : 200kS/s, 17 to 32CH : 100kS/s, more than 33CH: 50kS/s	—
658	History search cannot be performed in this mode.	—
659	Cannot start Dual Capture under these conditions. • Sample rate of HighSpeedSample is lower than LowSpeedSample or equal. • T/Div of HighSpeedSmample is longer than LowSpeedSample, or equal.	3.4 ¹
661	Balancing failed.	—
662	Cannot assign to this display group.	Chapter 5 ²
664	Go-Nogo is available while Trigger Mode is - 'Single' or 'Normal' - 'Auto' (Faster than 50ms/div)	4.1, ¹ chapter 14 ¹
666	Failed to measure statistics. Waveform data may be missing. If Cycle Statistics is specified, the instrument may be configured in a way that fails to detect the cycle.	11.3 ¹
667	Executing file access. Abort or wait until it is complete.	—
668	Image is being printed or saved. Wait until the execution of the command is complete.	—
669	Cannot be executed when the action mode is ON.	15.1 ¹

6.2 Messages and Corrective Actions

Code	Message	Chapter or Section
670	Cannot be executed when the dual capture setting is ON.	3.4 ¹
671	Cannot be executed when a SSD Recording is ON.	3.5 ¹
672	Cannot be executed when the time base setting is to be an External clock.	3.1, ¹ 3.2 ¹
675	Average practice can't be done because the record length of the history exceeds the record length that it can be carried out.	Chapter 9 ¹
676	Set the trigger mode and capture mode to On Start for SSD recording.	3.4, ¹ 4.1 ¹
677	Cannot do while selftest is executing.	6.3
678	Dual capture is not possible if the low speed sample rate is faster than 100ks/S or T/div is faster than 1s/div. Meet either of the conditions below. * Shorten the record length (slower sample rate). * Decrease T/Div.	3.4 ¹
679	Cannot start at the current record length. Shorten the record length or meet the following condition. * Set the trigger mode to Auto, decrease T/Div to less than 100 msec/div to enable roll mode. * Set the trigger mode to Single or On Start.	Chapter 3, ¹ 4.1 ¹
680	Averaging mode is not possible when the trigger mode is Single or On Start. Change the trigger mode.	4.1 ¹
681	Dual capture is not possible when set to average. Change the acquisition mode.	3.4 ¹
682	Cannot start when the HISTORY or SEARCH menu is being displayed. Press the ESC key to clear the menu before starting.	—
685	Cannot start when roll mode display while accumulate mode set to ON. Turn Off accumulate.	5.5 ¹
686	Cannot be executed when the acquisition mode is set to average. Change the mode.	3.1 ¹
688	SSD recording is valid when the record length is longer than 1M.	3.1 ¹
689	Cannot be executed on SSD Recording waveforms.	—
690	Cannot be executed on waveforms in dual capture mode.	—
691	File recorded in SSD is currently being analyzed. Files being analyzed cannot be deleted, or renamed.	—
692	The file which failed in the SSD record can't be read.	—
693	Cannot be executed when GO/NO-GO Mode is Zone.	Chapter 14 ¹
694	The measuring range is up to 4G points from measure start (TimeRange1).	11.1 ¹
695	Set acquisition mode to Normal when using a wave window trigger.	3.1 ¹
696	The wave window trigger cannot be used if the sampling rate is faster than 500 kS/s or slower than 10 kS/s. When a record length is shorter than 25k, set a T/div slower than 10ms/div.	Chapter 3 ¹
697	Range over. Change to an appropriate range then retry shunt calibration.	2.1, ¹ 2.5 ¹
698	Statistical processing cannot be performed on SSD Recording waveforms.	3.5 ¹
701	Execution error.	—
702	All search conditions are off. At least one condition should on.	9.2 ¹
704	Cannot execute Time search while T/div is faster than 100msec/div.	Chapter 3, ¹ 8.4 ¹
705	Cannot start Action mode while Trigger mode is SingleN.	4.1, ¹ 15.1 ¹
706	Cannot be executed when Go-Nogo Mode is On. Set the Go-Nogo Mode to OFF	Chapter 14 ¹
707	Cannot execute search while searched No. reached Maximum(1000).	—
708	Cannot execute or set while AutoScroll processing. Stop AutoScroll.	7.1 ¹
710	Cannot do these operations on SSD Recording waveforms. - WAVEform:SEND?	—
711	Cannot search for realtime analysis channel recorded on the SSD.	—
712	Cannot start while No GO/NO-GO condition.	Chapter 14 ¹

6.2 Messages and Corrective Actions

Code	Message	Chapter or Section
713	Cannot make wave zone from less than 2,000 points data, from more than 10,000,000 points data, or from less than 10division data.	—
715	Cannot start while USB Function setting is Storage. Cannot change USB Function setting while SSD Recording.	23.5 ¹
717	Cannot abort this process.	—
718	Cannot start while time of one file is less than 10sec.	—
719	Cannot execute Time search when the time base setting is to be an External clock.	8.4 ¹
721	Set the sub-channel number less than 16 while the record length shorter than 10k.	Chapter 2 ¹
722	Cannot execute search because RealTime Math mode is changed after acquisition.	Chapter 16 ¹
723	Cannot start action, when action folder mode is off and acquisition count is more than 1000.	15.1 ¹
724	Cannot start dual capture with action, when action folder mode is off and image save mode is on. Turn on action folder mode.	15.1 ¹
725	Cannot set because types of the harmonic analysis are different. Set a right analysis type.	Appendix 12 ²
727	Only in the case of 2 wiring systems, the setting of the efficiency is possible.	—
728	Cannot start while RecordLength of one file is less than 100k points.	—
729	Cannot set because of differencnt realtime analysis mode. Please set right mode.	Appendix 12 ²
730	Cannot be executed when Freerun Mode is On.	—
731	This is invalid items. Confirm settings on RealTime Analysis.	Appendix 12 ²
732	Cannot open channel menu because of all items are display off.	—
733	Cannot set to ON because of sample rate will be less than 1S/sec.	—
734	Cannot set gain adjustment while DC Offset cancel is ON.	2.1 ¹
738	Cannot set Pm and ETA to ON when an efficiency mode is OFF. Cannot set Pm to ON when an efficiency mode is Power. Please confirm an efficiency mode.	17.1 ¹
739	Cannot set Graph Window to Vector when harmonics type is Line RMS.	17.2 ¹
740	Cannot format SSD while USB Function setting is Storage.	23.5 ¹
741	Cannot set when: - The value is more than the sample rate. - The ratio of the sample rate is not integer.	—
744	Cannot Start GO/NO-GO, when data points are less than 2,000.	—
745	It is not possible to set 17 or more as BitSize to the 3rd FastCH. Please use 1st or 2nd FastCH for 17 or more bits of data.	2.11 ¹
746	If the input of the next FastCH is set to ON, BitSize cannot be set to 17 or more. Please turn OFF the input of the next FastCH to get 17 or more bits of data.	2.11 ¹
747	If the bit size of the previous FastCH is 17 or more, it is not possible to get this FastCH. Please set 16 or fewer as BitSize to the previous FastCH.	2.11 ¹
751	Your password is incorrect. Please enter the correct password.	23.6 ¹
752	It is not possible to set the same value for P1 & P2.	2.1 ¹
754	Under the following conditions, Event type data cannot be set. -External sample	3.1, ¹ 3.2 ¹
755	Time synchronization processing is being performed. Please try again after a few seconds.	—
756	Cannot execute because the firmware version or system mode do not match.	—
757	Cannot execute because there is a unit where no module is implemented.	—
758	Only connected units can be selected.	Chapter 22 ¹

¹ User's Manual, IM DL950-02EN

² Features Guide, IM DL950-01EN

Setup Errors (800 to 899)

Code	Message	Chapter or Section
800	Illegal date-time. Set the correct date and time.	—
801	Cannot set these file name. - Over 32 characters. - Contains character which are not allowed. - Inhibit MS-DOS file name. Enter an other file name.	19.4 ¹
802	Cannot set while recording.	3.5 ¹
803	Cannot be set unless "Time Sync" is OFF. Set "Time Sync" to OFF.	21.1 ¹
804	Cannot change settings during GO/NO-GO. Stop the GO/NO-GO (Stop the Acquire) .	Chapter 14 ¹
805	Cannot operate during shutdown.	—
806	Cannot be changed when trigger A is not X. Set the state of the channel corresponding to condition A to 'X'.	4.8 ¹ to 4.10 ¹
807	Cannot set while TimeSynchro setting not Off.	21.1 ¹
808	Cannot change when Channel Display is OFF or Math settings are invalid. Set the channel display ON or make appropriate Math settings.	Chapter 2, ¹ Chapter 13 ¹
809	Cannot change when External Clock is active.	Chapter 3 ¹
810	Cannot change while running.	—
811	Illegal math expression. Input a correct computing equation.	13.4 ¹
812	Cannot set this model	—
813	Cannot set anything other than Low Pass for a Gaussian filter. Change the Filter Type to another filter besides Gaussian.	2.13, ¹ 13.4 ¹
814	Cannot change settings while SSD recording. Stop SSD recording.	—
815	Cannot change settings during Action mode. Stop the Action.	15.1 ¹
816	Cannot set the channels which do not have modules installed.	6.4, Chapter 2 ¹
817	Cannot Set or Execute.	—
818	If the trigger mode is set to Single, Single(N), or OnStart, the acquisition mode cannot be set to Average.	3.1, ¹ 4.1 ¹
819	If the acquisition mode is Average, the trigger mode cannot be set to Single, Single (N), or OnStart.	3.1, ¹ 4.1 ¹
820	The acquisition mode cannot be set in the current record length.	—
821	The operation is not possible when waveforms are loaded. Unload the loaded files from the FILE menu.	—
822	Cannot be configured or executed during the search operation.	Chapter 8 ¹
823	Cannot be configured or executed during the history search operation.	9.2 ¹
824	The record cannot be selected.	Chapter 9 ¹
825	History record does not exist.	Chapter 9 ¹
826	Cannot be configured or executed while computation is in progress. Aborted when history display mode is set to One.	9.1 ¹
827	Cannot be configured or executed while updating the history all display. Aborted when history display mode is set to One.	9.1 ¹
828	This format cannot output with color.	—
829	Zones cannot be edited in the following cases: * When the main window is not displayed. * When the relevant waveform is not displayed.	14.1 ¹
830	The zone waveform does not exist.	14.1 ¹
831	The zone is being edited. To perform other operations, exit zone editing.	14.1 ¹

Code	Message	Chapter or Section
832	Zones determination is not possible in the following cases: * When the main window is not displayed. * When the relevant waveform is not displayed. * When the zone waveform does not exist.	Chapter 2, ¹ 6.2, ¹ 7.1, ¹ 12.1, ¹ 14.1 ¹
833	Processing statistics. To perform other operations, abort the statistical processing.	11.2 ¹
834	There are no channels to be analyzed, or you specified a channel that can not be set.	—
835	Cannot be set when the acquisition mode is set to average.	3.1 ¹
836	Cannot be changed when VScale is SPAN.	2.1 ¹
837	Cannot be set during SSD recording.	3.5 ¹
838	It is an unacceptable parameter to set up to the present module.	Chapter 1 ¹
839	It can't be set up during the dual capture practice or set to on.	3.4 ¹
840	If you are running on a T/div longer than 20s/div, you cannot change this setting.	3.1 ¹
841	Cannot be set because there are too many display channels at the current record length. Shorten the record length.	3.1 ¹
843	Cannot set accumulate during roll mode display.	Chapter 3 ²
844	Cannot change this setting during SSD recording.	3.5 ¹
845	Cannot change the History parameter when accumulate is ON. Turn OFF accumulate first.	5.5 ¹
846	P-P compression cannot be used to save when a record length is 1K.	—
847	Cannot set On this module.	—
848	Settings can not be entered for channels on which no strain module is mounted.	—
849	Setting error.	—
850	Cannot be set when the trace is set to a frequency module.	—
851	Cannot be set when the trace is set to a DSP channel.	—
852	Cannot set Math to OFF while FFT Window ON.	12.1 ¹
853	Cannot select this trace because it already selected.	—
854	Because a record length is too long, it can't be set up by the present number of indication channels.	Chapter 2, ¹ 3.1 ¹
855	Cannot change to such Record length while running. Set the trigger mode to Auto and decrease T/Div to less than 100 msec/div to enable roll mode, or set the trigger mode to Single or On Start.	—
856	Cannot Display setting to On. This CH didn't acquisition to memory.	—
857	Cannot set while DualCapture mode on.	3.4 ¹
858	Cannot set while action mode is on.	15.1 ¹
859	The maximum number of channels that can be used with the wave window trigger is 8.	4.14 ¹
860	Some devices do not have corresponding options, Cannot be set. All connected devices must have the option.	—
861	Synchronizing process is running on multiple connected units. Please try again after a while.	—
862	This operation cannot be performed on running in recorder mode.	—
863	This operation cannot be performed on multiple connected units.	—
864	This operation cannot be performed on multiple connected sub units.	—
865	Cannot set while multiple connected running.	22.3 ¹
866	Cannot operate while updating firmware.	—
867	Cannot be configured or executed while displaying the APPLICATION menu.	—
868	Cannot be specified because characters in the JIS level-2 kanji set are included. Create the file on the local drive, and then copy it to the network drive.	—
869	Cannot set while Go-Nogo mode. Turn Off Go-Nogo mode first.	Chapter 14 ¹
870	All sub-channel inputs are off. At least one inputs should on.	2.2, ¹ 2.4 ¹
871	No effective channel for Math Setup.	—
872	No effective channel for History Search Setup.	—

6.2 Messages and Corrective Actions

Code	Message	Chapter or Section
873	The capture window cannot be changed while the dual capture is in progress, and while the measuring is in progress.	—
874	Cannot set Save Range except 'Main' while PP-Comp save mode.	—
875	Cannot change or START when accumulate is ON. Turn OFF accumulate first.	5.5 ¹
876	Cannot operate while waiting for multiple connection.	22.2 ¹
877	Cannot set to display points under 100.	—
878	Cannot set Trigger mode while dual capture mode On.	—
879	Cannot set GoNogo mode while Math or FFT Window is On.	Chapter 12, ¹ Chapter 13 ¹
880	Cannot set Action mode to On, while SSD recording and dual capture mode On.	—
881	Cannot set for CH which ValueType is Float while running.	—
882	Cannot set while Single-N running.	2.9, ¹ 2.10 ¹
883	Cannot set Input to ON with limit of memory capacity.	2.9, ¹ 2.10 ¹
884	Cannot set to record length at 1k while installed a CAN bus monitor module.	2.9 ¹
885	Zoom rate is limited while installed a module which has sub-channels.	—
886	Cannot set RealTime Math mode to ON due to the following problems. -The slot is installed 720221, 720240, 720241, 720242 or 720243. -There are not any input which can be set to source for RealTime Math.	Chapter 16 ²
887	There are not any modules which can be set to source for this operation.	Chapter 16 ²
888	Cannot set RealTime Math mode to ON while RealTime Math Function is disable.	Chapter 16 ²
889	Cannot change RealTime Math mode during roll display.	Chapter 3 ²
890	LIN Monitor does not support Float data.	2.10 ¹
891	Cannot set Math mode to ON while FFT points is set over 50k. Set to under 20k points.	12.2 ¹
892	Cannot set Math operation while FFT window is open.	12.1 ¹
893	Cannot set that item. It cannot be measured for Logic module.	11.1 ¹
894	Cannot set DC Offset Cancel to ON due to: - Coupling is not DC. - The DC offset Cancel has not been executed!	2.1 ¹
895	The password entered the first time is different from the password entered the second time. Reenter the password for the second time.	—
896	It is not possible to set the subchannel sample interval to be 1 second or more.(sample rate to be 1S/s or less.)	Chapter 3 ¹
897	This operation cannot be performed in recorder mode.	—
898	Cannot change when Internal Clock is active.	Chapter 3 ¹

1 User's Manual, IM DL950-02EN

2 Features Guide, IM DL950-01EN

System Errors (900 to 999)

Code	Message	Chapter or Section
900	No module installed. Install the module.	—
901	Failed to backup setup data. Will initialize. Backup battery may be low.	—
902	The firmware is not suitable for this system. Install the proper firmware.	—
903	The USB device's power consumption exceeded the capacity of the USB hub.	—
905	Lower the sample rate or reduce the number of measuring channels.	Chapter 2, ¹ Chapter 3 ¹

Code	Message	Chapter or Section
906	The fan has stopped. Service is required. The unit will shutdown.	—
907	Internal temperature is too high. Maintenance service is required. It will shutdown automatically.	—
908	Check the measured current and the number of probes that you are using.	3.6
909	SSD is full.	19.10 ¹
910	Key protect is enabled. To release the protection, press the PROTECT key or enter the password.	23.7 ¹
911	Fan for Input modules stopped. Cannot start. Maintenance service is required.	—
912	Fan for CPU stopped. Maintenance service is required. It will shutdown automatically.	—
913	LCD BackLight Failure. Maintenance service is required.	—
914	Cannot start while this module configuration. 720240, 720241, 720242 should use in CH13 - CH16. 720243 should use in CH9 - CH16.	—
915	It installed the module which cannot support by this machine.	—
916	It installed 701250/701255 which cannot use by this machine. Maintenance service is required.	—
917	Hardware configuration error occurred. Restart this machine. If it occurred again, maintenance service is required.	—
918	Error occurred while ImageFile process.	—
919	Key operate not available while system error occurred	—
920	Firmware overwriting error occurred.	—
921	Help files are not decompressed after firmware version up. Push [UTILITY] key and select F5 [Selftest]. Select F1[Selftest] menu and [VersionUp -> #5Help] to decompress them.	—
922	GPS module does not work.	—
923	Setting was changed. The unit will initialize.	—
926	This 720242 module does not support event format. Version upgrade is required.	—
927	Fan for back board stopped. Maintenance service is required. It will shutdown automatically.	—
929	System Error	—
930	Slot 1 EEPROM error.	—
931	Slot 2 EEPROM error.	—
932	Slot 3 EEPROM error.	—
933	Slot 4 EEPROM error.	—
934	Slot 5 EEPROM error.	—
935	Slot 6 EEPROM error.	—
936	Slot 7 EEPROM error.	—
937	Slot 8 EEPROM error.	—
938	Internal flash write error.	—
939	Internal flash verify error.	—
940	The unit will shutdown as an abnormal temperature was detected,	—
942	The USB power was turned off because USB overcurrent was detected, Please disconnect the connected USB device and restart it.	3.5
943	The GPS power was turned off because GPS overcurrent was detected. Please disconnect the GPS unit and restart it.	3.5

6.2 Messages and Corrective Actions

Code	Message	Chapter or Section
944	A module power failure was detected. Acquisition and multiple unit sync was stopped. Turn the power of DL950 on and off to restart. If it occurred again, maintenance service is required.	3.5
948	Unable to change option for any of the following reasons. - Conflict with option already set - No required option	—
960	Detected the error on multi-units synchronization, it disconnected. Unsaved data will be lost when resynchronizing.	—

- 1 User's Manual, IM DL950-02EN
- 2 Features Guide, IM DL950-01EN

Note

If servicing is required, first see if initializing the instrument fixes the problem.

6.3 Carrying Out Self-Tests

This section explains the following settings for testing whether the instrument's keyboard, memory, SD card interface, and internal SSD are functioning properly:

UTILITY Self Test Menu

1. Press **UTILITY**. The UTILITY menu appears.
You can also tap  at the upper left of the screen to display the main menu, and tap **OTHERS** and then **UTILITY** to display the UTILITY menu.
2. Tap **SelfTest** and then **SelfTest**, or press these soft keys.
The following menu appears.

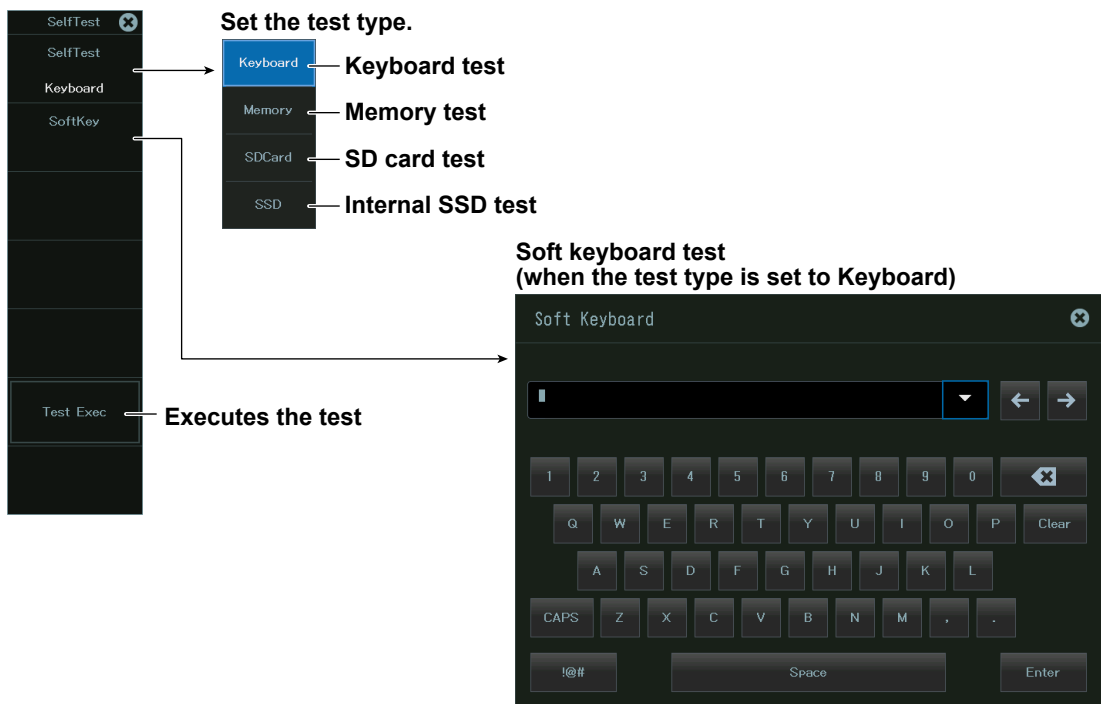

Setting the Test Type (Self Test)

Keyboard: Tests whether or not the front panel keys are operating correctly and whether or not the soft keyboard accepts input properly. The front panel keys are operating properly if the names of the keys that you press are highlighted. The soft keyboard is operating properly if you can enter the specified characters.

Memory: Tests whether or not the internal CPU board RAM and ROM are operating properly. If they are operating properly, "Pass" appears. If an error occurs, "Error" appears.

SD Card: Tests whether the SD card interface is operating properly. If an error occurs, "Error" appears.

SSD: Tests whether or not the internal SSD is operating properly. If an error occurs, "Error" appears.

If an Error Occurs during a Self-Test

If an error occurs even after you carry out the following procedure, contact your nearest YOKOGAWA dealer.

- Execute the self-test again several times.
- Confirm whether or not the media being tested is properly inserted.

6.4 Viewing System Information (Overview)

This section explains how to view this instrument's system information.

UTILITY Overview Menu

1. Press **UTILITY**. The UTILITY menu appears.
You can also tap  at the upper left of the screen to display the main menu, and tap **OTHERS** and then **UTILITY** to display the UTILITY menu.
2. Tap **Overview**, or tap the soft key.
A system overview appears.

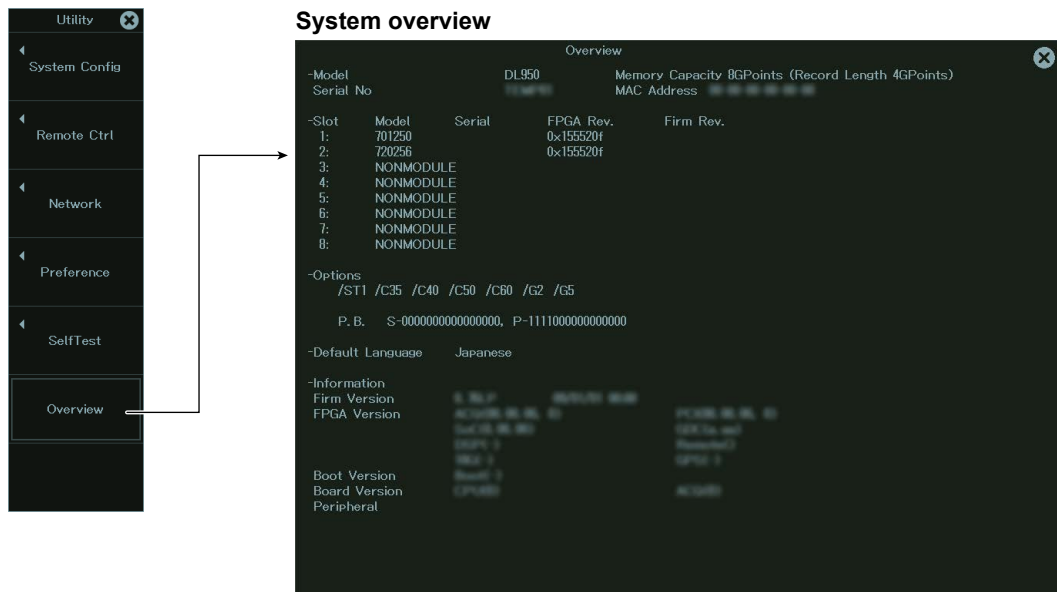

Displayed Information

Model, Memory Capacity (Record Length)	Model, memory size (record length)
Serial No	The instrument number and MAC address
Slot	The model and serial number of the module installed in each slot*
Options	The installed options
Default Language	The default language
Information	The firmware version number, date, etc.

* If the following modules are installed, their instrument numbers are also displayed at the corresponding slots. 720256, 720250, 720268, 720266, 701281, 720281, 720212, 720211, 720221, 720241, 720242, 720243, 720254
The instrument numbers of other modules are not displayed.

6.5 Recommended Part Replacement

The life and replacement period for expendable items varies depending on the conditions of use. Refer to the table below as a general guideline.

For part replacement and purchase, contact your nearest YOKOGAWA dealer. You cannot replace them by yourself.

Parts with Limited Service Life

Part Name	Service Life
LCD backlight	Under normal conditions of use, approximately 50000 hours

Consumable Parts

Part Name	Recommended Replacement Interval
Cooling fan	3 years
Backup battery (lithium battery)	5 years

6.6 Disposal

When disposing of this instrument, follow the laws and ordinances of the country or region where the product will be disposed of.

If you are disposing of the product in the EU, see also page xix.

7.1 Signal Input Section

Item	Specifications	
Type	Plug-in input unit	
Number of slots	8	
Maximum number of input channels	32 channels (when 4-CH modules are used in all slots) 128 channels (when 16CH temperature/voltage modules are used in all slots)	
Memory size	Standard	1 Gpoint (up to 500 Mpoint per channel)
	/M1 option	4 Gpoint (up to 2 Gpoint per channel)
	/M2 option	8 Gpoint (up to 4 Gpoint per channel)

7.2 Scope Mode Features

Waveform Acquisition and Display

Item	Specifications	
Acquisition mode	Normal	Normal waveform acquisition
	Envelope	Holds peak values at the maximum sample rate, regardless of the time axis setting
	Averaging	Average count: 2 to 65536 (2 ⁿ steps), Infinite (attenuation constant: 2 to 256, 2 ⁿ steps)
Record length	Standard model	10k, 25k, 50k, 100k, 250k, 500k, 1M, 2.5M, 5M, 10M, 25M (32Ch), 50M (16Ch), 100M (8Ch), 250M (4Ch), 500M (2Ch)
	/M1	10k, 25k, 50k, 100k, 250k, 500k, 1M, 2.5M, 5M, 10M, 25M, 50M, 100M (32Ch), 250M (16Ch), 500M (8Ch), 1G (4Ch), 2G (2Ch)
	/M2	10k, 25k, 50k, 100k, 250k, 500k, 1M, 2.5M, 5M, 10M, 25M, 50M, 100M, 250M (32Ch), 500M (16Ch), 1G (8Ch), 2G (4Ch), 4G (2Ch)
Sample rate	Can be set up to the module's maximum sample rate for each channel (there are limits based on the record length)	
Selectable time scale range	100 ns/div to 1 s/div (1-2-5 steps), 2 s/div, 3 s/div, 4 s/div, 5 s/div, 6 s/div, 10 s/div, 20 s/div, 30 s/div 1 min/div to 6 min/div (1 min steps), 10 min/div, 12 min/div, 30 min/div 1 h/div to 6 h/div (1 h steps), 8 h/div, 10 h/div, 12 h/div 1 day/div to 5 day/div (1 day steps)	
Action performed at the end of acquisition	Waveform data saving (simultaneous saving in binary, ASCII, and MATLAB formats) Image saving, measurement result saving, mail transmission, buzzer notification	
Event recording	Records up to 100 events using the event input terminal	
Zoom	Two windows	
Display format	1, 2, 3, 4, 5, 6, 8, 12, 16 split displays (set for each display group)	
Maximum number of displayed traces	Up to 64 traces for each display group	
Display interpolation	Off, sign interpolation, linear interpolation, pulse interpolation	
X-Y display	Select X and Y axes from analog input waveforms and Math waveforms, up to four traces in two windows	
Accumulation	Waveform accumulation: Infinite, 2, 4, 8, 16, 32, 64, 128	
History function	Maximum number of histories	5000
	Display mode	Single waveform display, all waveform display, average display
Dual capture	Data acquisition of the same waveform is possible at two different sample rates	
Low-speed sampling	Maximum sample rate	100 kS/s
	Selectable time scale range	1 s/div, 2 s/div, 3 s/div, 4 s/div, 5 s/div, 6 s/div, 10 s/div, 20 s/div, 30 s/div, 1 min/div to 6 min/div (1 min steps), 10 min/div, 12 min/div, 30 min/div, 1 h/div to 6 h/div (1 h steps), 8 h/div, 10 h/div, 12 h/div, 1 day/div to 5 day/div (1 day steps)
High-speed sampling	Maximum sample rate	Module's maximum sample rate
	Selectable time scale range	100 ns/div to 1 s/div (1-2-5 steps), 2 s/div, 3 s/div, 4 s/div, 5 s/div, 6 s/div, 10 s/div, 20 s/div, 30 s/div, 1 min/div

7.2 Scope Mode Features

Item	Specifications
Record length	Standard 10k, 25k, 50k, 100k, 250k, 500k, 1M, 2.5M, 5M model
	/M1 10k, 25k, 50k, 100k, 250k, 500k, 1M, 2.5M, 5M, 10M, 25M
	/M2 10k, 25k, 50k, 100k, 250k, 500k, 1M, 2.5M, 5M, 10M, 25M, 50M
SSD recording (/ST1)	Maximum sample rate Depends on the number of used channels. 2 MS/s (when 1CH is used), 200 kS/s (when 16CH is used) maximum
	Record length
Standard model	1M, 2.5M, 5M, 10M, 25M, 50M, 100M, 250M, 500M, 1G (32Ch), 2G (16Ch), 4G (8Ch), 5G (8Ch), 10G (4Ch), 20G (2Ch)
	/M1 1M, 2.5M, 5M, 10M, 25M, 50M, 100M, 250M, 500M, 1G, 2G, 4G (32Ch), 5G (32Ch), 10G (16Ch), 20G (8Ch), 50G (4Ch)
	/M2 1M, 2.5M, 5M, 10M, 25M, 50M, 100M, 250M, 500M, 1G, 2G, 4G, 5G, 10G (32Ch), 20G (16Ch), 50G (8Ch)

Vertical and Horizontal Control

Item	Specifications
Channel on/off	CHn, CHn_m, RTMATHn, and MATHn can be turned on and off separately.
Vertical axis zooming	×0.1 to ×100 (varies depending on the module type) By setting the scale using upper and lower limits
Vertical position setting	Waveforms can be moved in the range of ±5 div (not possible when top and bottom scale values are set).
Linear scaling	Can be set to Ax+B mode or P1-P2 mode (only for voltage, stress, and frequency)
Roll mode display	When the trigger mode is set to auto, single, or on-start, and the time axis setting is greater than or equal to 100 ms/div
Deskewing	±1 μs (modules with sample rates at 10 MS/s or faster)

Triggering Section

Item	Specifications
trigger mode	Auto, Auto Level, Normal, Single, Single (N), On-start
Selectable trigger level range	0 ±10 div
Trigger hysteresis	When measuring voltage: Select from ±0.1 div, ±0.5 div, ±1 div.
	When measuring temperature: Select from ±0.5 °C, ±1.0 °C, and ±2.0 °C.
	When measuring strain: Select from ±2.5 %, ±12.5 %, ±25 % of range.
	When measuring acceleration: Select from ±0.1 div, ±0.5 div, ±1 div of range.
	When measuring frequency: Select from ±0.01 div, ±0.5 div, ±1 div of range.
	CAN/CAN FD/LIN/SENT: ±0.01 div, ±0.5 div, ±1.0 div of display span
Real time math	±0.01 div, ±0.5 div, ±1.0 div of display span
Power and harmonic computation	±0.01 div, ±0.5 div, ±1.0 div of display span
Selectable trigger position range	0 to 100 % (as a percentage of the display record length in 0.1 % steps)
Selectable trigger delay range	0 to 10 s (resolution: 10 ns)
Selectable hold-off time range	0 to 10 s (resolution: 10 ns)
Manual trigger	Input through dedicated keys or communication commands
Simple trigger	trigger source CHn, CHn_m (specified input channel, specified bit for logic), RTMATHn, external, time, line
	Trigger slope Rising, falling, both edges (rising, falling only for logic)
	Clock trigger Date (year/month/day), time (hour/minute/second), time interval (10 seconds to 24 hours)

Item	Specifications
Enhanced trigger	<p>trigger source CHn, CHn_m (specified input channel, specified bit for logic), RTMATHn, external</p> <hr/> <p>Trigger type</p> <p>A→B(N) After condition A is met, the instrument triggers when condition B is met N times. Count specifications: 1 to 10000 Condition A: Enter/Exit Condition B: Enter/Exit</p> <hr/> <p>A Delay B After condition A is met, the instrument triggers when condition B is met for the first time after the specified time elapses. Specified time: 0 to 10 s (resolution: 10 ns) Condition A: Enter/Exit Condition B: Enter/Exit</p> <hr/> <p>Edge on A The instrument triggers on the logical OR of edges while condition A is met. Condition A: True/False</p> <hr/> <p>AND Triggers on the AND of multiple state conditions (including window triggers)</p> <hr/> <p>OR Triggers on the OR of multiple edge or state conditions (including window triggers)</p> <hr/> <p>Period Triggers when the period of condition T meets one of the following conditions.</p> <p>T > Time Longer than the specified time, time range: 0.02 μs to 10 s, resolution: 0.01 μs</p> <p>T < Time Shorter than the specified time, time range: 0.02 μs to 10 s, resolution: 0.01 μs</p> <p>T1 < T < T2 Within the specified time range, specified time T1: 0.02 μs to 9999999.99 μs, T2: 0.03 μs to 10 s, resolution: 0.01 μs</p> <p>T < T1, T2 < T Outside the specified time range, specified time T1: 0.02 μs to 9999999.99 μs, T2: 0.03 μs to 10 s, resolution: 0.01 μs</p> <hr/> <p>Pulse Width Triggers when the time from when trigger B conditions are met meets one of the following conditions.</p> <p>B > Time Time for trigger B conditions to not be met is longer than the specified time, specified time: 0.01 μs to 10 s, resolution: 0.01 μs</p> <p>B < Time Time for trigger B conditions to not be met is shorter than the specified time, specified time: 0.02 μs to 10 s, resolution: 0.01 μs</p> <p>B Time Out Time when trigger B conditions continue to be met is longer than the specified time, specified time: 0.01 μs to 10 s, resolution: 0.01 μs</p> <p>B Between Time when trigger B conditions continue to be met is within the specified time. Triggers when the conditions are no longer met Specified time T1: 0.01 μs to 9999999.99 μs, T2: 0.02 μs to 10 s, resolution: 0.01 μs</p> <hr/> <p>WaveWindow Power supply waveform monitoring trigger, number of target channels: 8 max. Source frequency: 40 to 1 kHz, resolution: 1 Hz, operating sample rate: 10 k to 500 kS/s</p>

7.2 Scope Mode Features

Analysis

Item	Specifications	
Cursors	T-Y waveforms	Horizontal / Vertical / H&V / Marker / Degree
	X-Y waveforms	Horizontal / Vertical / H&V / Marker
	FFT waveforms	Marker / Peak
Automated measurement of waveform parameters		
Measured parameters	Analog waveform, Math	PP, Amp, Max, Min, High, Low, Avg, Mid, Rms, Sdev, +Over, -Over Rise, Fall, Freq, Period, +Width, -Width, Duty, Pulse, Burst1, Burst2, Avg.Freq, AvgPeriod, Int1TY, Int2TY, Int1XY, Int2XY, Delay
	Logic waveform	Freq, Period, Pulse, Duty, Avg.Freq, Delay
Statistical processing	Statistical items:	Max, Min, Avg, Sdv, Cnt
	Maximum number of cycles	64,000
	Maximum measurement range	4 Gpoints (memory recording), 100 Mpoints (internal storage)
	Continuous statistical processing	Statistical processing is performed while waveforms are acquired.
	cyclic statistical processing	Automatically measures the waveform parameters once per cycle and performs statistical processing on the parameters.
History statistical processing	Automatically measures the waveform parameters on the data of each history waveform and performs statistical processing on the parameters.	
Waveform computation	Operators	Basic arithmetic with coefficients, binarization, shift
	Number of computations	Up to 8
	Computation length	Up to 2 Mpoint (when one waveform is used), 250 kpoint (when eight waveforms are used)
User-defined math function (/G02 option)	Operators	Equations can be created using the following operators. ABS, SQRT, LOG, EXP, NEG, SIN, COS, TAN, ATAN, PH, DIF, DDIF, INTG, IINTG, BIN, P2, P3, F1, F2, FV, PWHH, PWHL, PWLH, PWLL, PWXX, DUTYH, DUTYL, FILT1, FILT2, HLBT, MEAN
	Average setting	Simple average, exponential average, cycle average, peak computation
FFT	Waveform to be computed	CHn, CHnm, RTMATHn, MATHn
	Number of windows	2
	Number of FFT waveforms	Up to eight waveforms (up to four waveforms/window)
	Computation range	From the specified computation time start point until the specified number of points have been computed
	Math points	1k/2k/5k/10k/20k/50k/100k
	Type/sub type	PS-LOGMAG (For the /G02 option below) LS-MAG, LS-LOGMAG, LS-PHASE, LS-REAL, LS-IMAG RS-MAG, RS-LOGMAG PS-MAG PSD-MAG, PSD-LOGMAG CS-MAG, CS-LOGMAG, CS-PHASE, CS-REAL, CS-IMAG TF-MAG, TF-LOGMAG, TF-PHASE, TF-REAL, TF-IMAG CH-MAG
	Time window	Hanning, Hamming, FlatTop, Rectangle Exponential (/G02 option)
	Average setting (/G02 option)	Domain: Time axis, frequency axis Type: Simple average, exponential average, peak computation
GO/NO-GO determination A selected operation can be performed according to the determination condition on the acquired waveform.		
Zone determination	Number of determination zones	Up to 6
	Number of source waveforms	Up to 16
	Combinations	AND, OR
Parameter determination	Number of determination parameters	Up to 16
	Combinations	AND, OR

Item	Specifications
Operation after determination	Screen capture data saving, waveform data saving, buzzer notification, mail transmission
Zooming and searching	You can search for and then expand and display a portion of the displayed waveform.
Type	Edge Searches by counting the number of rising and falling edges Logic pattern Searches by counting the logic pattern Event Searches for an event number. Time Searches for a date and time.
History search	Searches through history waveforms for specified conditions.
Zone search	Number of determination zones Up to 4 Combinations AND, OR
Parameter search	Number of determination parameters Up to 4 Combinations AND, OR

7.3 Recorder Mode Features

Waveform Acquisition and Display

Item	Specifications
Record conditions	Preset time recording Records data for the specified time period from the start point Continuous recording Records data for the specified time period before stopping Trigger recording Records data based on trigger position setting
Acquisition mode	Memory recording Records waveforms to internal memory Saving during and at the end of memory recording Records to internal memory and then saves waveform data or screen capture data to files SSD recording (/ST1) Records waveforms to internal SSD storage
Acquisition mode	Normal Normal waveform acquisition Envelope Holds peak values at the maximum sample rate, regardless of the time axis setting
Recording time	1 s to 50 days
Sample interval	100 ns to 200 ms (1-2-5 series)
Action performed at the end of recording	Waveform data saving (binary, ASCII, and MATLAB formats) Screen capture data saving, measurement results saving, buzzer notification, mail transmission
SSD recording (/ST1)	Minimum sample interval Depends on the number of used channels. 500 ns (when 1CH is used), 5 μ s (when 16CH is used) minimum Maximum number of recorded points 20 Gpoint, 50 Gpoint (/M1, /M2) (there are limits based on the number of used channels)
Event recording	Records up to 100 events using the event input terminal
Display time range	10 μ s to 10 s (1-2-5 steps), 20 s, 30 s, 40 s, 50 s, 60 s, 100 s, 200 s, 300 s 10 min to 60 min (10 min steps), 100 min 2 hour, 5 hour, 10 hour to 60 hour (10 hour steps), 80 hour, 100 hour 5 day, 10 day, 20 day, 30 day, 40 day, 50 day
Zoom	One window
Display format	1, 2, 3, 4, 5, 6, 8, 12, 16 split displays (set for each display group) of TY display
Maximum number of displayed traces	Up to 64 traces for each display group
X-Y display	Number of windows 2 Number of X-Y traces Up to eight traces (up to four traces/window) Select the X and Y axes from CHn, CHn_m, RTMATHn, MATHn.

7.3 Recorder Mode Features

Vertical and Horizontal Control

Item	Specifications
Channel on/off	CHn, CHn_m, RTMATHn, and MATHn can be turned on and off separately.
Vertical axis zooming	By setting the scale using upper and lower limits
Linear scaling	Can be set to Ax+B mode or P1-P2 mode (only for voltage, stress, and frequency)
Deskewing	$\pm 1 \mu\text{s}$ (modules with sample rates at 10 MS/s or faster)

Triggering Section

Item	Specifications
Selectable trigger level range	0 \pm measurement range
Trigger hysteresis	When measuring voltage: Select from $\pm 1 \%$, $\pm 5 \%$, $\pm 10 \%$ of range. When measuring temperature: Select from $\pm 0.5 \text{ }^\circ\text{C}$, $\pm 1.0 \text{ }^\circ\text{C}$, and $\pm 2.0 \text{ }^\circ\text{C}$. When measuring strain: Select from $\pm 2.5 \%$, $\pm 12.5 \%$, $\pm 25 \%$ of range. When measuring acceleration: Select from $\pm 1 \%$, $\pm 5 \%$, $\pm 10 \%$ of range. When measuring frequency: Select from $\pm 0.1 \%$, $\pm 5 \%$, $\pm 10 \%$ of range. CAN/CAN FD/LIN/SENT: Select from $\pm 0.1\%$, $\pm 5\%$, $\pm 10\%$ of span.
Manual trigger	Using a dedicated key
trigger source	CHn, CHn_m (specified input channel, specified bit for logic), RTMATHn, external trigger, time
Trigger type	Edge Rising, falling, rising and falling (rising, falling only for logic) Time Date (year/month/day), time (hour/minute/second) OR Triggers on the OR of multiple trigger source edges (including window triggers) AND Triggers on the AND of multiple state conditions (including window triggers)

Analysis

Item	Specifications
Cursors	T-Y waveforms Horizontal / Vertical / H&V / Marker / Degree X-Y waveforms Horizontal / Vertical / H&V / Marker FFT waveforms Marker / Peak
Automated measurement of waveform parameters	
Measured parameters	Analog waveform, Math PP, Amp, Max, Min, High, Low, Avg, Mid, Rms, Sdev, +Over, -Over Rise, Fall, Freq, Period, +Width, -Width, Duty, Pulse, Burst1, Burst2, Avg.Freq, AvgPeriod, Int1TY, Int2TY, Int1XY, Int2XY, Delay Logic waveform Freq, Period, Pulse, Duty, Avg.Freq, Delay
Statistical processing	Statistical items: Max, Min, Avg, Sdv, Cnt Maximum number of cycles 64,000 Maximum measurement range 4 Gpoint (memory recording), 100 Mpoint (SSD recording) cyclic statistical processing Automatically measures the waveform parameters once per cycle and performs statistical processing on the parameters.
Waveform computation	Operators Basic arithmetic with coefficients, binarization, shift Number of computations Up to 8 Computation length Up to 2 Mpoint (when one waveform is used), 250 kpoint (when eight waveforms are used)
User-defined math function (/G02 option)	Operators Equations can be created using the following operators. ABS, SQRT, LOG, EXP, NEG, SIN, COS, TAN, ATAN, PH, DIF, DDIF, INTG, IINTG, BIN, P2, P3, F1, F2, FV, PWHH, PWHL, PWLH, PWLL, PWXX, DUTYH, DUTYL, FILT1, FILT2, HLB, MEAN Average setting None
FFT	Waveform to be computed CHn, MATHn Number of windows 2 Number of FFT waveforms Up to eight waveforms (up to four waveforms/window)

Item	Specifications	
	Computation range	From the specified computation time start point until the specified number of points have been computed
	Math points	1k/2k/5k/10k/20k/50k/100k
	Type/sub type	PS-LOGMAG (For the /G02 option below) LS-MAG, LS-LOGMAG, LS-PHASE, LS-REAL, LS-IMAG RS-MAG, RS-LOGMAG PS-MAG PSD-MAG, PSD-LOGMAG CS-MAG, CS-LOGMAG, CS-PHASE, CS-REAL, CS-IMAG TF-MAG, TF-LOGMAG, TF-PHASE, TF-REAL, TF-IMAG CH-MAG
	Time window	Hanning, Hamming, FlatTop, Rectangle Exponential (/G02 option)
	Average setting	None
Zooming and searching	You can search for and then expand and display a portion of the displayed waveform.	
Type	Edge	Searches by counting the number of rising and falling edges
	Logic pattern	Searches by counting the logic pattern
	Event	Searches for an event number.
	Time	Searches for a date and time.

7.4 Real time math (/G03, /G05)

Item	Specifications	
Math expression	Real time math using hardware	
Max. number of math channels	16 (separate from the input channels)	
Computation result storage format	Single-precision floating-point (32 bit)	
Real time math		
Math rate	Max. math rate: 10 MS/s or 1 MS/s for polynomials	
Math type	Basic arithmetic with coefficients:	Expressions: +, -, ×, / Coefficients: A, B, and C can be defined. Addition: $(A \times S1) + (B \times S2) + C$ Subtraction: $(A \times S1) - (B \times S2) + C$ Multiplication: $(A \times S1) \times (B \times S2) + C$ Division: $(A \times S1)/(B \times S2) + C$ Range of coefficients A, B, and C: $\pm 9.9999E+30$ to $\pm 9.9999E+30$
	Quartic polynomial:	$A*s4 + B*s3 + C*s2 + D*s + E$ Range of coefficients A, B, C, D, and E): $\pm 9.9999E+30$ to $\pm 9.9999E+30$
	Coefficient multiplied by addition or subtraction of sources:	$K * (s1 \pm s2 \pm s3 \pm s4)$ Range of coefficient K: $\pm 9.9999E+30$ to $\pm 9.9999E+30$
	Logic signal/analog waveform conversion:	Uses the logic signal as an analog signal, and performs a scaling conversion
	Differentiation:	Differentiation using a fifth order Lagrange interpolation formula
	Integration:	Integration reset condition: When waveform acquisition starts, when a channel is turned on or off
	Selectable reset conditions:	Over Limit Zero Cross to Positive: When the source signal is moving in the positive direction and crosses zero Zero Cross to Negative: When the source signal is moving in the negative direction and crosses zero
	Common logarithm	Log1: $Kx\text{Log}_{10}(s1/s2)$, Log2: $Kx\text{Log}_{10}(s1)$
	Square root (Sqr1):	$\sqrt{s1^2 \pm s2^2}$
	Square root (Sqr2):	\sqrt{s}
	Frequency:	The period is measured, and the frequency is calculated as 1/period.

7.4 Real time math (/G03, /G05)

Item	Specifications
Period:	The period from one edge condition to the next edge condition is measured. Resolution: 100 ns. Max. period: 10 s
Edge count:	Counts the specified edges
Demodulation of the pulse width modulated (PWM) signal:	The PWM-modulated signal is integrated over the modulation period and converted into analog signal.
Torque:	The torque is computed from the measured frequency and the specified coefficient.
Rms value:	$\sqrt{\frac{1}{N} \sum_{n=1}^N s(n)^2}$ <p>The math period is from one zero crossing of the specified signal to the next zero crossing. Alternatively, the period is the specified time: 1 to 500 ms, resolution: 1 ms</p>
Effective power:	$\frac{1}{T} \int_0^T (s1 \cdot s2) dt$ <p>The math period is the integrated value of the time from one zero crossing of the specified signal to the next zero crossing.</p>
Effective power integration	$\int_0^T (s1 \cdot s2) dt$ <p>The value "s1xs2" is integrated over time.</p>
Cosine:	cos(s)
Sine:	sin(s)
Arc tangent:	atan(s1/s2)
Angle of rotation:	Pulse integration is performed based on the specified A, B, and Z phase signals. The angle of the bit signal is computed as an absolute value from the logic input. Max. setting of the number of pulses per rotation: 65535
Electrical angle:	Calculates the phase difference between (1) the angle that was determined from the logic signals that were specified for phases A, B, and Z, and (2) the fundamental wave component that was determined from the discrete Fourier transform of the waveform that was specified as the target. Calculates the phase difference (electrical angle) between the angle of rotation and drive current of the motor.
Knocking filter: (only when the /VCE option is installed)	When the signal level of the math source waveform that is being differentiated is less than or equal to the elimination level, the output is set to 0.
Resolver:	The angle of rotation is computed from the carrier signal, sine signal, and cosine signal. Supported carrier frequencies: 1 kHz to 20 kHz Tracking filter band setting: 2 kHz, 1 kHz, 250 Hz, 100 Hz Maximum measurable angle acceleration: 140000 rps ² (when the tracking filter is set to 2 kHz) 54000 rps ¹ (when the tracking filter is set to 2 kHz) 1800 rps ² (when the tracking filter is set to 250 Hz) 180 rps ² (when the tracking filter is set to 100 Hz)
3 phase resolver:	Calculates the angle of rotation from the two sine signals that are generated from the detection coil of the 3 phase resolver depending on the angle of the rotor. Supported carrier frequencies: 1 kHz to 20 kHz Tracking filter band setting: 2 kHz, 1 kHz, 250 Hz, 100 Hz
Math source waveforms	All input channels including sub channels. (there are limitations based on the operator) Math results can be specified as sources of another channel. However, you can only specify math results of channels whose numbers are smaller than the channel that you are specifying sources for.
Math delay	A uniform delay for each math operation, regardless of the number of math channels
Filter on math results	IIR low-pass filter all math results Full, cutoff frequencies (128 kHz, 64 kHz, 32 kHz, 16 kHz, 8 kHz, 4 kHz, 2 kHz, 1 kHz, 500 Hz, 250 Hz, 125 Hz, 62.5 Hz)

Item	Specifications
Vertical scale	Set based on the specified top and bottom scale values, simultaneous use of zooming using the scale knob and moving using the position knob
Digital filter	Digital filter for input channels. Math can be performed on up to 16 channels at the same time.
Target input modules	720212, 720211, 701250, 701255, 720250, 701251, 720268, 701261, 701262, 701265, 720266, 701275, 701270, 701271
Filter types	<p>Mean (moving average) Filter format: FIR (moving average) Filter type: LPF Sample rate: Selectable from 1 M, 100 k, 10 k, 1 k [S/s] Number of moving average points: Selectable from 2, 4, 8, 16, 32, 64, 128</p> <hr/> <p>Gaus: Filter format: FIR Filter type: LPF Filter order: 5 to 49 Cutoff frequency: 300 kHz to 2 Hz Resolution: 300 kHz to 30 kHz, in steps of 2 kHz Resolution: 29.8 kHz to 3 kHz, in steps of 200 Hz Resolution: 2.98 kHz to 300 Hz, in steps of 20 Hz Resolution: 298 Hz to 30 Hz, in steps of 2 Hz Resolution: 29.8 Hz to 2 Hz, in steps of 0.2 Hz Cutoff characteristic: $-3.0 \times (f/f_c)^2$ (where f is the frequency and f_c is the cutoff frequency)</p> <hr/> <p>Sharp: Filter format: FIR Filter type: LPF, HPF, BPF Filter order: 5 to 194 LPF: Cutoff frequency: 300 kHz to 2 Hz Resolution: 300 kHz to 30 kHz, in steps of 2 kHz Resolution: 29.8 kHz to 3 kHz, in steps of 200 Hz Resolution: 2.98 kHz to 300 Hz, in steps of 20 Hz Resolution: 298 Hz to 30 Hz, in steps of 2 Hz Resolution: 29.8 Hz to 2 Hz, in steps of 0.2 Hz HPF: Cutoff frequency: 300 kHz to 200 Hz Resolution: 300 kHz to 30 kHz, in steps of 2 kHz Resolution: 29.8 kHz to 3 kHz, in steps of 200 Hz Resolution: 2.98 kHz to 200 Hz, in steps of 20 Hz BPF: Center frequency: 300 kHz to 300 Hz Resolution: 300 kHz to 30 kHz, in steps of 2 kHz Resolution: 29.8 kHz to 3 kHz, in steps of 200 Hz Resolution: 2.98 kHz to 300 Hz, in steps of 20 Hz Bandwidth: 200 kHz, 150 kHz, 100 kHz, 50 kHz, 20 kHz, 15 kHz, 10 kHz, 5 kHz, 2 kHz, 1.5 kHz, 1 kHz, 500 Hz, 200 Hz (there are limits based on the center frequency) Cutoff characteristic: $-40 \text{ dB}@2f_c$ (LPF), $-40 \text{ dB}@0.5f_c$ (HPF) Phase: Linear phase characteristics</p>

7.4 Real time math (/G03, /G05)

Item	Specifications
IIR:	<p>Filter format: IIR (Butterworth)</p> <p>Filter type: LPF, HPF, BPF</p> <p>Filter order: 4</p> <p>LPF: Cutoff frequency: 300 kHz to 2 Hz Resolution: 2 kHz for 300 kHz to 30 kHz Resolution: 200 Hz for 29.8 kHz to 3 kHz Resolution: 20 Hz for 2.98 kHz to 0.3 kHz Resolution: 2 Hz for 298 Hz to 2 Hz</p> <p>HPF: Cutoff frequency: 300 kHz to 20 Hz Resolution: 2 kHz for 300 kHz to 30 kHz Resolution: 200 Hz for 29.8 kHz to 3 kHz Resolution: 20 Hz for 2.98 kHz to 20 Hz</p> <p>BPF: Center frequency: 300 kHz to 60 Hz Resolution: 2 kHz for 300 kHz to 12 kHz Resolution: 200 Hz for 11.8 kHz to 1.2 kHz Resolution: 20 Hz for 1.18 kHz to 60 Hz Bandwidth: 200 kHz, 150 kHz, 100 kHz, 50 kHz, 20 kHz, 15 kHz, 10 kHz, 5 kHz, 2 kHz, 1.5 kHz, 1 kHz, 500 Hz, 200 Hz, 100 Hz (there are limits based on the center frequency)</p> <p>Cutoff characteristics: -24 dB/Oct</p> <p>Phase: Nonlinear phase characteristics</p>
IIR-Lowpass:	<p>Filter format: IIR (Butterworth)</p> <p>Filter type: LPF</p> <p>Filter order: 4</p> <p>Cutoff frequency: 128 kHz, 64 kHz, 32 kHz, 16 kHz, 8 kHz, 4 kHz, 2 kHz, 1 kHz, 500 Hz, 250 Hz, 125 Hz, 62.5 Hz (no limits based on the sample rate)</p>

Power Math (/G05)

Item	Specifications
Math expression	Real time math using hardware
Math source channels	Voltage input channels excluding the 720221
Max. math rate	10 MS/s (100 kS/s for power math)
Math result output channels	Power analysis math: Real time math RTMATH13, RTMATH14; harmonic analysis math RTMATH15, RTMATH16; fixed
Computed result	Single-precision floating-point (32 bit)
Power analysis	<p>Max. number of analyzable systems Up to two three-phase systems can be computed simultaneously.</p> <p>Max. number of simultaneous math parameters 118 when one system is measured 58 × 2 systems when two systems are measured</p> <p>Supported wiring systems Single-phase two-wire (1P2W); single-phase three-wire (1P3W); or three-phase three-wire (3P3W), Three-phase three-wire system that uses a three-voltage three-current method (3P3W; 3V3A); three-phase four-wire system (3P4W)</p> <p>Delta math function Three-phase three-wire (3P3W) → three-phase three-wire system that uses a three-voltage three-current method (3P3W; 3V3A) Three-phase three-wire (3V3A) → three-phase four-wire system (3P4W) (delta → star) Three-phase four-wire system (3P4W) → three-phase three-wire (3V3A) (star → delta)</p>

Item	Specifications
Math items	<p>Rms voltage and current of each phase</p> <p>Voltage and current simple average of each phase (DC)</p> <p>AC voltage and current components of each phase (AC)</p> <p>Active power</p> <p>Apparent power</p> <p>Reactive power</p> <p>Power factor</p> <p>Current phase difference</p> <p>Voltage and current frequencies</p> <p>Maximum voltage and current, minimum voltage and current</p> <p>Maximum power, minimum power</p> <p>Integrated watt-hour, integrated watt-hour of each polarity (positive and negative)</p> <p>Integrated ampere-hour, integrated ampere-hour of each polarity (positive and negative)</p> <p>Apparent energy</p> <p>Reactive energy</p> <p>Impedance of the load circuit</p> <p>Series resistance of the load circuit</p> <p>Series reactance of the load circuit</p> <p>Parallel resistance of the load circuit</p> <p>Parallel reactance of the load circuit</p> <p>Three-phase voltage unbalanced factor</p> <p>Three-phase current unbalanced factor</p> <p>Motor output math</p> <p>Power efficiency (select motor output result and power math result or power math result of two systems)</p>
Rms math system	Select true rms value or rectified mean value calibrated to the rms value
Math sync mode	<p>Edge: Select a signal. Computed using zero-crossings.</p> <p>Auto Timer: Specify the time. Computed at specified time intervals.</p> <p>Transient: Select a signal. For the first measurement, computation starts on both zero-crossing edges. After that, computation is performed on the specified zero-crossing edge. Signal stop is determined by the stop prediction function. Switches to Auto Timer after stopping.</p>
Channel selection for edge	Select a single channel from own phase voltage, own phase current, or other voltage/current.
Sync channel filter	<p>If sync mode is set to Edge, low-pass filter can be selected.</p> <p>Cutoff frequency: Select from 128 kHz, 64 kHz, 32 kHz, 16 kHz, 8 kHz, 4 kHz, 2 kHz, 1 kHz, 500 Hz, 250 Hz, 125 Hz, and 62.5 Hz.</p>
Harmonic analysis	<p>Max. number of analyzable systems 1</p> <p>Max. number of analyzable frequencies Fundamental wave 1 kHz</p> <p>FFT points 4096</p> <p>Supported wiring systems Single-phase two-wire (1P2W); single-phase three-wire (1P3W); or three-phase three-wire (3P3W), Three-phase three-wire system that uses a three-voltage three-current method (3P3W; 3V3A); three-phase four-wire system (3P4W)</p> <p>Delta math function Three-phase three-wire (3P3W) → three-phase three-wire system that uses a three-voltage three-current method (3P3W; 3V3A) Three-phase three-wire (3V3A) → three-phase four-wire system (3P4W) (delta → star) Three-phase four-wire system (3P4W) → three-phase three-wire (3V3A) (star → delta)</p> <p>Math mode Rms analysis mode, power analysis mode</p> <p>Math items Rms analysis mode: Rms percentage content of the 1st to 40th harmonic Phase angles of the 1st to 40th harmonic Total rms value Distortion factor (IEC) Distortion factor (CSA)</p>

7.4 Real time math (/G03, /G05)

Item	Specifications
	Power analysis mode
	Active powers from the 1st to the 35th harmonic
	Active power percentage content from the 1st to the 35th harmonic
	Phase angles of the 1st to 35th harmonic
	Total active powers
	Total reactive powers
	Total apparent powers
	Power factor
	1st harmonic rms voltage
	1st harmonic rms current
	1st harmonic voltage phase angle
	1st harmonic current phase angle
Sync channel	Rms analysis mode: Analysis source channel Power analysis mode: Select one channel from voltage and current.
Sync channel filter	Low-pass filter can be selected. Cutoff frequency: Select from 128 kHz, 64 kHz, 32 kHz, 16 kHz, 8 kHz, 4 kHz, 2 kHz, 1 kHz, 500 Hz, 250 Hz, 125 Hz, and 62.5 Hz.

7.5 Time Axis

Item	Specifications
Time axis accuracy	±4.6 ppm
External clock input	Clock input through the external clock input terminal

7.6 Display

Item	Specifications
Display	12.1-inch color TFT LCD (capacitive touch panel)
Display format	T-Y, X-Y, FFT, harmonics (/G05)
Display resolution	1024×768 (XGA)
Resolution of the waveform display	801×656 (normal), 1001×656 (wide)
Defective pixels	3 ppm or less of the total number of pixels including RGB

7.7 Saving Data

Saving Data

Item	Specifications
Types of saved data	Measured data, analysis results, settings, screen capture
Measured data format	Binary (.WDF), MATLAB (.MAT), text (.CSV) Maximum file size (MAT, CSV format): 2 GB
Data storage device	Internal storage, SD memory card, USB storage, network drive

Saving Screen Captures

Item	Specifications
Screen capture data format	PNG, JPEG, BMP
Screen capture data color	Monochrome, color, color (reverse), grayscale
Data storage device	Internal storage, SD memory card, USB storage, network drive

7.8 PC Data Streaming

Item	Specifications
Connection type	USB, Ethernet, 10G Ethernet (/C60)

7.9 Multi-Unit Synchronization (/C50)

Item	Specifications
Connector type	SFP
Ports	4 (up to four sub units can be connected to a main unit)
Synchronization accuracy	$\pm(30 \text{ ns} + 1 \text{ sample})$ (typical value)
Function	Start and stop from the main unit, combination trigger across units
Maximum cable length	20 m

7.10 Storage

Internal storage (/ST1 option)

Item	Specifications
Number of drives	1
Media type	SSD
Available space	512 GB

SD memory card

Item	Specifications
Number of slots	1
Maximum capacity	128 GB
Compatible cards	SD, SDHC, and SDXC memory cards

USB storage

Item	Specifications
Compatible USB storage devices	Mass storage devices that comply with USB Mass Storage Class Ver. 1.1
Available space	8 TB max. Partition format: MBR, GPT; format type: FAT16/FAT32/exFAT

7.11 USB Ports for Peripherals

Item	Specifications
Connector type	USB type A (receptacle)
Electrical and mechanical	USB Rev. 2.0 compliant
Supported transfer modes	HS (High Speed; 480 Mbps), FS (Full Speed; 12 Mbps), LS (Low Speed; 1.5 Mbps)
Compatible devices	Mass storage devices that comply with USB Mass Storage Class Ver. 1.1 104 or 109 keyboards that comply with USB HID Class Ver. 1.1 Mouse devices that comply with USB HID Class Ver. 1.1 HP Inkjet printers compatible with USB Printer Class Ver. 1.0, BrotherPocketJET printers
Number of ports	2
Power supply	5 V, 500 mA (each port)

External Printer Output

Item	Specifications
Supported models	Brother Pocket JET printers, 300 dpi models HP inkjet printers, single function models For details on models, see the catalog or website.
Output format	Screen hard copy, monochrome or color (color available only with HP printers)

7.12 Auxiliary I/O Section

External Trigger Input Terminal

Item	Specifications
Connector type	BNC
Input level	TTL (0 to 5 V)
Minimum pulse width	100 ns
Detected edge	Rising or falling

Trigger Output Terminal

Item	Specifications		
Connector type	BNC		
Output level	5 V CMOS		
Output delay time	(1.8 μ s to 4.5 μ s) + 1 sample (typical value) Applies to 1 MS/s or faster modules. Depends on the installed module.		
Output type	Normal format	Logic:	Falls when a trigger occurs and rises when a signal acquisition is completed
		Output hold time:	100 ns or more
	Pulse format	Logic:	Transmits a pulse when a trigger occurs
		Pulse width:	1 ms, 50 ms, 100 ms, 500 ms

External Clock Input Terminal

Item	Specifications
Connector type	BNC
Input level	TTL (0 to 5 V)
Maximum input frequency	9.5 MHz
	100 kHz (for envelope)
Minimum pulse width	50 ns
Detected edge	Rising

Video Signal Output

Item	Specifications
Connector type	D-sub 15 pin, receptacle
Output format	Analog RGB
Output resolution	XGA-compliant output, 1024 \times 768 dots Approx. 60-Hz Vsync (66-MHz dot clock frequency)

GO/NOGO Output

Item	Specifications
Connector type	Screwless terminal block
Output level	5 V CMOS

External Start/Stop Input

Item	Specifications
Connector type	Screwless terminal block
Input level	TTL (0 to 5 V) or contact input

Event Input

Item	Specifications
Connector type	Screwless terminal block
Input level	TTL (0 to 5 V) or contact input

Sample Clock Output

Item	Specifications
Connector type	Screwless terminal block
Output level	5 V CMOS
Output operation	Outputs a clock signal at the specify frequency
Frequency range	5 Hz to 200 kHz (1-2-5 steps)

COMP Output (Probe Compensation Signal Output Terminal)

Item	Specifications
Output signal frequency	1 kHz \pm 1 %
Output amplitude	1 V _{p-p} \pm 10 %

Probe power (/P4 or /P8 option)

Item	Specifications
Output terminals	4 (/P4), 8 (/P8)
Output voltage	\pm 12 V
Output current	Up to a total of 2.4 A (/P4), up to a total of 4.8 A (/P8)*

* 2.4 A per four outputs

GPS Interface (/C35 option)

Item	Specifications
Input connector	9-pin Mini DIN
Compatible GPS unit	720940 (optional accessory)
Function	Instrument clock synchronization Sample clock synchronization
Synchronization accuracy*	\pm 200 ns (typical value when locked to GPS signal)*

* The figure is based on results obtained when the GPS unit is installed in a location with good line of sight to GPS satellites. The accuracy may not be attained depending on the measurement location, the location of satellites when the measurement is taken, the weather, and influence caused by obstruction.

IRIG Interface (/C35 option)

Item	Specifications
Input connector	BNC
Number of input connectors	1
Compatible IRIG signals	A006, B006, A136, B126
Input impedance	50 Ω /5 k Ω switchable
Maximum input voltage	\pm 8 V
Function	Instrument clock synchronization Sample clock synchronization
Clock sync range	\pm 60 ppm
Synchronization accuracy	No drift from the input signal

7.13 Computer Interface

USB-PC Connection

Item	Specifications
Connector type	USB type B (receptacle)
Electrical and mechanical specifications	USB Rev. 3.0 compliant
Supported transfer modes	FS (Full Speed) mode (12 Mbps), HS (High Speed) mode (480 Mbps), SS (Super Speed) mode (5 Gbps)
Number of ports	1
Supported protocols	Functions as a device that conforms to one of the following two protocols. USBTMC-USB488 (USB Test and Measurement Class Ver. 1.0)* Communication commands can be used through USB. Mass Storage Class Ver.1.1 Only reading is possible from the instrument's internal storage through PC access. (Operations, such as formatting, are not possible.)
PC system requirements	Windows 8.1, Windows 10

* A separate driver is required.

Ethernet

Item	Specifications
Connector type	RJ-45 modular jack
Ports	1
Electrical and mechanical specifications	IEEE802.3 compliant
Transmission system	Ethernet (1000BASE-T/100BASE-TX/10BASE-T)
Communication protocol	TCP/IP
Supported services	DHCP, DNS, SNMP client, SMTP client, FTP client, FTP server, Web server, LPR, VXI-11, HiSLIP, Socket PTP slave, PTP master (/C40 option)
Time synchronization feature	Sync source: Supports IEEE1588-2008 (PTP v2) Supports PTP packets of Layer3 (UDP/IPv4) and Layer2 (Ethernet) Slave feature only (without the /C40 option) Slave and master features (with the /C40 option) Supports Ordinary Clock Supports E2E delay correction Supports 2-step Sync messages Sync targets: Synchronization accuracy: Instrument clock, sample clock ±150 ns (typical value) when 1000BASE-T is used and an Ethernet switch is not used Master sync clock (/C40 option): Internal clock, GPS (/C35 option)

10G Ethernet (/C60)

Item	Specifications
Connector type	SFP+
Ports	1
Electrical and mechanical specifications	IEEE802.3 compliant
Transmission system	Ethernet (10GBASE-R)
Communication protocol	TCP/IP
Supported services	DHCP, DNS, SNMP client, SMTP client, FTP client, FTP server, Web server, Socket, VXI-11 HiSLIP

7.14 General Specifications

Item	Specifications
Standard operating conditions	Ambient temperature: 23 ±5 °C
	Ambient humidity: 20 to 80 %RH
	Supply voltage and frequency errors: Within ±1 % of rating
	After a 30 minute warm-up and after calibration
Recommended calibration period	1 year
Warm-up time	At least 30 minutes
Operating environment	Temperature: 5 °C to 40 °C
	Humidity: 20 to 85 %RH (no condensation)
	Altitude: 2000 m or less
Storage environment	Temperature: -20 °C to 60 °C
	Humidity: 20 to 85 %RH (no condensation)
Power supply	Rated supply voltage: 100 to 120 VAC, 220 to 240 VAC (auto switching)
	Permitted supply voltage range: 90 to 132 VAC, 198 to 264 VAC
	Rated supply frequency range: 48 Hz to 63 Hz
	Maximum power consumption: 280 VA
	Withstand voltage: 1500 VAC for 1 minute between the power supply and case
	Insulation resistance: 10 MΩ or higher at 500 VDC between the power supply and case
Installation orientation	Vertical, horizontal, tilted
External dimensions	Approx. 375 mm (W) × 259 mm (H) × 202 mm (D), excluding the handle and protrusions
Weight	Approx. 7.5 kg (main unit only, no options)
Instrument cooling method	Forced air cooling (air vents on the left and top panels)
Battery backup	Settings and clock are backed up with the internal lithium battery. Life: Approx. five years (at an ambient temperature of 23 °C)
Safety standards	Compliant standards: EN61010-1, EN61010-2-030, EN61010-031, EN60825-1 Pollution degree 2
	Measurement category: See the specifications of each module.
Emissions	Compliant standards: EN61326-1 Class A Table 2 (for use in industrial locations), EN61326-2-1, EN55011 Class A, Group 1 EN61000-3-2, EN61000-3-3 EMC Regulatory Arrangement in Australia and New Zealand EN61326-1: Class A Table2 (for use in industrial locations), EN55011 Class A, Group 1 Korea Electromagnetic Conformity Standard (한국 전자파적합성기준) KN11, KN6100-6-2
	This product is classified as Class A (for use in industrial environments). Operation of this product in a residential area may cause radio interference. Further, when a measurement lead or probe is connected to an input module or when connected to the device under measurement, the emission requirements may be exceeded. In such cases, the user will be required to correct the interference.

Item	Specifications																																																																								
	<p>Cable conditions</p> <p>USB port Use a shielded USB cable that is 3 m or less in length. Attach a ferrite core¹ to the instrument side of the cable.</p> <p>Ethernet port (Ethernet) Use a category 5 or better STP cable that is 30 m or less in length. Attach a ferrite core¹ to the instrument end of the cable.</p> <p>I/O port Use a shielded USB cable that is 3 m or less in length. Attach a ferrite core² by passing the instrument end of the cable twice through the core.</p> <p>I/O port (BNC terminal) Use a shielded BNC cable that is 3 m or less in length. Attach a ferrite core¹ to the instrument side of the cable.</p> <p>Video signal output cable Use a shielded cable that is 3 m in length or less.</p> <p>GPS port Use the dedicated accessory. Attach a ferrite core¹ to the instrument end of the cable.</p> <p>Probe power cable Use the dedicated cable. Attach a ferrite core² by passing the instrument end of the cable twice through the core.</p> <p style="text-align: center;">Example of passing the cable through twice</p> 																																																																								
Immunity	<p>Compliant standards</p> <p>EN61326-1 Table 2 (for use in industrial locations), EN61326-2-1 When a measurement lead or probe is connected to an input module or when connected to the device under measurement, the immunity requirements may not be met. In such cases, the user will be required to correct the interference.</p> <p>Influence in the immunity environment (criteria A)</p> <table border="0"> <tbody> <tr><td>720211</td><td>≤±50 mV</td><td>(Input 1:1, 10 mV/div)</td></tr> <tr><td>720212</td><td>≤±50 mV</td><td>(Input 1:1, 10 mV/div)</td></tr> <tr><td>701250</td><td>≤±20 mV</td><td>(Input 1:1, 5 mV/div)</td></tr> <tr><td>720250</td><td>≤±20 mV</td><td>(Input 1:1, 5 mV/div)</td></tr> <tr><td>701251</td><td>≤±3 mV</td><td>(Input 1:1, 1 mV/div)</td></tr> <tr><td>720254</td><td>≤±15 mV</td><td>(Input 1:1, 10 mV/div)</td></tr> <tr><td>701255</td><td>≤±25 mV</td><td>(Input 1:1, 5 mV/div)</td></tr> <tr><td>720256</td><td>≤±15 mV</td><td>(Input 1:1, 5 mV/div)</td></tr> <tr><td>720268</td><td>≤±300 mV</td><td>(Input 1:1, 50 mV/div)</td></tr> <tr><td>701261</td><td>≤±3 mV</td><td>(Input 1:1, 5 mV/div)</td></tr> <tr><td>701262</td><td>≤±3 mV</td><td>(Input 1:1, 5 mV/div)</td></tr> <tr><td>701265</td><td>≤±0.05 mV</td><td>(Input 1:1, 0.1 mV/div)</td></tr> <tr><td>720266</td><td>≤±0.05 mV</td><td>(Input 1:1, 0.1 mV/div)</td></tr> <tr><td>720221</td><td>≤±2 mV</td><td>(Input 1:1, 1 mV/div, data update period =100 ms)</td></tr> <tr><td>701270</td><td>≤±100 μSTR</td><td>(±500 μSTR range, gauge factor 2)</td></tr> <tr><td>701271</td><td>≤±100 μSTR</td><td>(±500 μSTR range, gauge factor 2)</td></tr> <tr><td>701275</td><td>≤±6 mV</td><td>(Input 1:1, 5 mV/div)</td></tr> <tr><td>701281</td><td>≤±0.01 Hz</td><td>(Frequency, 0.1 Hz/div)</td></tr> <tr><td>720281</td><td>≤±0.01 Hz</td><td>(Frequency, 0.1 Hz/div)</td></tr> <tr><td>720230</td><td>No bit errors</td><td></td></tr> <tr><td>720240</td><td>No errors</td><td></td></tr> <tr><td>720242</td><td>No errors</td><td></td></tr> <tr><td>720241</td><td>No errors</td><td></td></tr> <tr><td>720243</td><td>No errors</td><td></td></tr> </tbody> </table> <p>Cable conditions Same as the emission cable conditions</p> <p>Definitions of criteria Criteria A: During testing, “influence in the immunity environment” described above is met. Criteria B: The instrument continues to function and is controllable throughout testing. The instrument does not change operation modes, and data changes do not persist. Criteria C: Temporary losses of functionality (such as measurement stopping, etc.) are recovered from through the intervention of the operator.</p>	720211	≤±50 mV	(Input 1:1, 10 mV/div)	720212	≤±50 mV	(Input 1:1, 10 mV/div)	701250	≤±20 mV	(Input 1:1, 5 mV/div)	720250	≤±20 mV	(Input 1:1, 5 mV/div)	701251	≤±3 mV	(Input 1:1, 1 mV/div)	720254	≤±15 mV	(Input 1:1, 10 mV/div)	701255	≤±25 mV	(Input 1:1, 5 mV/div)	720256	≤±15 mV	(Input 1:1, 5 mV/div)	720268	≤±300 mV	(Input 1:1, 50 mV/div)	701261	≤±3 mV	(Input 1:1, 5 mV/div)	701262	≤±3 mV	(Input 1:1, 5 mV/div)	701265	≤±0.05 mV	(Input 1:1, 0.1 mV/div)	720266	≤±0.05 mV	(Input 1:1, 0.1 mV/div)	720221	≤±2 mV	(Input 1:1, 1 mV/div, data update period =100 ms)	701270	≤±100 μSTR	(±500 μSTR range, gauge factor 2)	701271	≤±100 μSTR	(±500 μSTR range, gauge factor 2)	701275	≤±6 mV	(Input 1:1, 5 mV/div)	701281	≤±0.01 Hz	(Frequency, 0.1 Hz/div)	720281	≤±0.01 Hz	(Frequency, 0.1 Hz/div)	720230	No bit errors		720240	No errors		720242	No errors		720241	No errors		720243	No errors	
720211	≤±50 mV	(Input 1:1, 10 mV/div)																																																																							
720212	≤±50 mV	(Input 1:1, 10 mV/div)																																																																							
701250	≤±20 mV	(Input 1:1, 5 mV/div)																																																																							
720250	≤±20 mV	(Input 1:1, 5 mV/div)																																																																							
701251	≤±3 mV	(Input 1:1, 1 mV/div)																																																																							
720254	≤±15 mV	(Input 1:1, 10 mV/div)																																																																							
701255	≤±25 mV	(Input 1:1, 5 mV/div)																																																																							
720256	≤±15 mV	(Input 1:1, 5 mV/div)																																																																							
720268	≤±300 mV	(Input 1:1, 50 mV/div)																																																																							
701261	≤±3 mV	(Input 1:1, 5 mV/div)																																																																							
701262	≤±3 mV	(Input 1:1, 5 mV/div)																																																																							
701265	≤±0.05 mV	(Input 1:1, 0.1 mV/div)																																																																							
720266	≤±0.05 mV	(Input 1:1, 0.1 mV/div)																																																																							
720221	≤±2 mV	(Input 1:1, 1 mV/div, data update period =100 ms)																																																																							
701270	≤±100 μSTR	(±500 μSTR range, gauge factor 2)																																																																							
701271	≤±100 μSTR	(±500 μSTR range, gauge factor 2)																																																																							
701275	≤±6 mV	(Input 1:1, 5 mV/div)																																																																							
701281	≤±0.01 Hz	(Frequency, 0.1 Hz/div)																																																																							
720281	≤±0.01 Hz	(Frequency, 0.1 Hz/div)																																																																							
720230	No bit errors																																																																								
720240	No errors																																																																								
720242	No errors																																																																								
720241	No errors																																																																								
720243	No errors																																																																								
Environmental standards	EU RoHS Directive compliant																																																																								

1 (TDK ZCAT2035-0930A, YOKOGAWA part No.: A1190MN)

2 (TDK ZCAT1325-0530A, YOKOGAWA part No.: A1181MN)

7.15 Module Specifications

4CH 10MS/s, 16bit Isolation Module (720256)

Item	Specifications								
Standard operating conditions	Temperature: 23 ±5 °C Humidity: 20 to 80 % RH Immediately after calibration after a 30 minute warm-up								
Effective measurement range	20 div (display range: 10 div)								
Number of input channels	4								
Input coupling settings	AC, DC, GND								
Maximum sample rate	10 MS/s								
Input type	Isolated unbalanced								
Frequency characteristics ¹ (3 dB point a when sine wave of amplitude ±3 div is applied)	DC to 3 MHz								
Voltage scale setting	5 mV/div to 20 V/div (1-2-5 steps) (when using 1:1 probe factor)								
Maximum input voltage (at a frequency of 1 kHz or less)	Combined with the 700929 (10:1), 702902 (10:1), or 701947 (100:1): ² 600 V (DC+ACpeak) Combined with the 701901 + 701954 (1:1): ⁴ 200 V (DC+ACpeak) Direct input (cable that does not comply with the safety standards): ⁶ 42 V (DC+ACpeak)								
maximum rated voltage to ground	Working voltage of safety standard Combined with 700929 (10:1), 702902 (10:1), 701947 (100:1) ³ or combined with 701901 + 701954 (1:1): ⁵								
Between input and case	300 Vrms CAT II, 400 Vrms (measurement category Other (O) 1500 V transient overvoltage)								
Between inputs (at a frequency of 1 kHz or less)	Direct input (cable that does not comply with the safety standards) ⁷ 42 V (DC+ACpeak) (CAT II, 30 Vrms)								
Vertical (voltage) axis accuracy	±(0.25% of 10 div)								
DC accuracy ¹									
Input connector	BNC connector (isolated type)								
Input impedance	1 MΩ ±1 %, approx. 32 pF								
3 dB point when AC coupled	10 Hz or less (1 Hz or less when using the 700929 or 702902, 0.1 Hz or less when using the 701947)								
Common mode rejection ratio	80 dB (50/60 Hz) or more (typical value ⁸)								
Residual noise level (input section shorted)	±0.05 div 5 mV/div to 20 mV/div (typical value ⁸) ±0.025 div 50 mV/div to 20 V/div (typical value ⁸)								
Withstand voltage	2300 Vrms for 2 seconds (across each input terminal and earth) (60 Hz)								
Insulation resistance	500 VDC, 10 MΩ or more (across each input terminal and earth)								
A/D converter resolution	16 bit (2400 LSB/div)								
Temperature coefficient	Zero point: ±0.02 % of 10 div/°C 50 mV/div to 20 V/div (typical value ⁸) ±0.10 % of 10 div/°C 5 mV/div to 20 mV/div (typical value ⁸) Gain: ±0.02%/°C (typical value ⁸)								
Bandwidth limit	Analog Filter Select from Full and 400 kHz Cutoff characteristics: -18 dB/OCT (typical value ⁸) Digital Filter Cutoff frequency: AUTO, 128 kHz, 64 kHz, 32 kHz, 16 kHz, 8 kHz, 4 kHz, 2 kHz, 1 kHz, 500 Hz, 250 Hz, 125 Hz, 62.5 Hz Filter format: IIR (except AUTO) Cutoff frequency (fc) when set to AUTO								
	<table border="1"> <thead> <tr> <th>Sample rate</th> <th>Cutoff frequency (fc)</th> </tr> </thead> <tbody> <tr> <td>500 kS/s or more</td> <td>200 kHz</td> </tr> <tr> <td>200 kS/s to 100 S/s</td> <td>40 % of the sample rate</td> </tr> <tr> <td>50 S/s or less</td> <td>40 Hz</td> </tr> </tbody> </table>	Sample rate	Cutoff frequency (fc)	500 kS/s or more	200 kHz	200 kS/s to 100 S/s	40 % of the sample rate	50 S/s or less	40 Hz
Sample rate	Cutoff frequency (fc)								
500 kS/s or more	200 kHz								
200 kS/s to 100 S/s	40 % of the sample rate								
50 S/s or less	40 Hz								
Probe attenuation settings	Voltage probe: 1:1, 10:1, 100:1, 1000:1 Current probe: 1 A:1 V, 10 A:1 V, 100 A:1 V, 1 A:10 mV, 1 A:2.5 mV Clamp-on probe: 1 A:10 mV, 1 A:2.5 mV								

Item	Specifications
Cutoff frequency characteristics of the anti-aliasing filter (AAF)	When the filter is set to AUTO, the anti-aliasing filter (AAF) and low-pass filter are automatically set according to the sample rate.

Sample rate	AAF	Low-Pass Filter
10 MS/s	200 kHz	400 kHz
5 MS/s	200 kHz	400 kHz
2 MS/s	200 kHz	400 kHz
1 MS/s	200 kHz	400 kHz
500 kS/s	200 kHz	400 kHz
200 kS/s	80 kHz	400 kHz
100 kS/s	40 kHz	400 kHz
50 kS/s	20 kHz	400 kHz
20 kS/s	8 kHz	400 kHz
10 kS/s	4 kHz	400 kHz
5 kS/s	2 kHz	400 kHz
2 kS/s	800 Hz	400 kHz
1 kS/s	400 Hz	400 kHz
500 S/s	200 Hz	400 kHz
200 S/s	80 Hz	400 kHz
100 S/s	40 Hz	400 kHz
50 S/s or less	40 Hz	400 kHz
Ext sample	OFF	OFF

When AC coupled. DC components are not attenuated to 1/10 or 1/100 when the 700929, 702902, or 701947 is in use.

- 1 Value measured under standard operating conditions

Combined with the 700929, 702902, or 701947

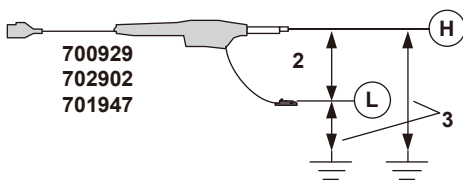

Combined with the 701901 and 701954

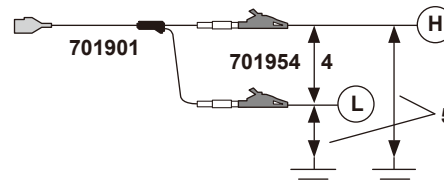

Direct input (cable that does not comply with the safety standards)

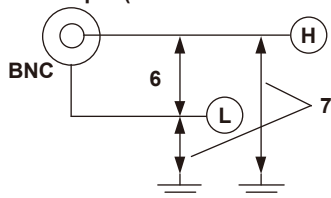

- 8 Typical values represent typical or average values. They are not strictly warranted.

7.15 Module Specifications

High-Speed 10 MS/s, 12-Bit Isolation Module (701250)

Item	Specifications
Standard operating conditions	Temperature: 23 ±5 °C Humidity: 20 to 80 % RH After a 30 minute warm-up and after calibration
Effective measurement range	20 div (display range: 10 div)
Number of input channels	2
Input coupling settings	AC, DC, GND
Maximum sample rate	10 MS/s
Input type	Isolated unbalanced
Frequency characteristics ¹ (3 dB point a when sine wave of amplitude ±3 div is applied)	DC to 3 MHz
Voltage scale setting	5 mV/div to 20 V/div (1-2-5 steps) (when using 1:1 probe factor)
Maximum input voltage (at a frequency of 1 kHz or less)	Combined with the 700929 (10:1), 702902 (10:1), or 701947 (100:1): ² 600 V (DC+ACpeak) Combined with the 701901 + 701954 (1:1): ⁴ 200 V (DC+ACpeak) (as a value that meets the safety standard) 250 V (DC+ACpeak) (maximum allowable voltage, as a value that does not damage the instrument when applied) Direct input (cable that does not comply with the safety standards): ⁶ 42 V (DC+ACpeak)
maximum rated voltage to ground Between input and case Between inputs (at a frequency of 1 kHz or less)	Working voltage of safety standard Combined with 700929 (10:1), 702902 (10:1), 701947 (100:1) ³ or combined with 701901 + 701954 (1:1): ⁵ 300 Vrms CAT II, 400 Vrms (measurement category Other (O) 1500 V transient overvoltage) Direct input (cable that does not comply with the safety standards): ⁷ 42 V (DC+ACpeak) (CAT II, 30 Vrms)
Vertical (voltage) axis accuracy DC accuracy ¹	±(0.5 % of 10 div)
Input connector	BNC connector (isolated type)
Input impedance	1 MΩ ±1 %, approx. 35 pF
3 dB point when AC coupled	10 Hz or less (1 Hz or less when using the 700929 or 702902, 0.1 Hz or less when using the 701947)
Common mode rejection ratio	80 dB (50/60 Hz) or more (typical value ⁸)
Residual noise level (input section shorted)	±400 μV or ±0.06 div whichever is greater (typical value ⁸)
Withstand voltage	2300 Vrms for 2 seconds (across each input terminal and earth) (60 Hz)
Insulation resistance	500 VDC, 10 MΩ or more (across each input terminal and earth)
A/D converter resolution	12 bits (150 LSB/div)
Temperature coefficient	Zero point: 5 mV/div to 20 V/div: ±(0.05 % of 10 div)/°C (typical value ⁸) Gain: ±0.02%/°C (typical value ⁸)
Bandwidth limit	Select from Full, 500 kHz, 50 kHz, 5 kHz, 500 Hz Cutoff characteristics: -18 dB/OCT (typical value ⁸)
Probe attenuation settings	Voltage probe: 1:1, 10:1, 100:1, 1000:1 Current probe: 1 A:1 V, 10 A:1 V, 100 A:1 V Clamp-on probe: 1 A:10 mV, 1 A:2.5 mV

1 Value measured under standard operating conditions

Combined with the 700929, 702902, or 701947

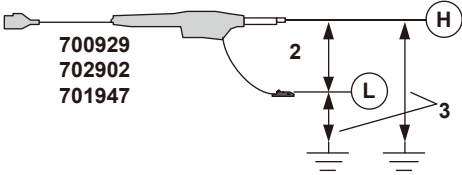

Combined with the 701901 and 701954

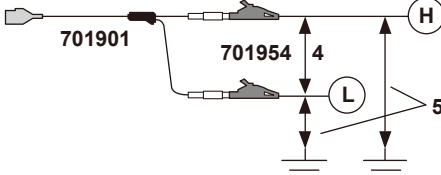

Direct input (cable that does not comply with the safety standards)

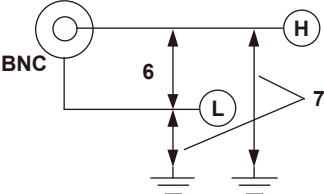

8 Typical values represent typical or average values. They are not strictly warranted.

7.15 Module Specifications

High-Speed 10 MS/s, 12-Bit Isolation Module (720250)

Item	Specifications
Standard operating conditions	Temperature: 23 ±5 °C Humidity: 20 to 80 % RH After a 30 minute warm-up and after calibration
Effective measurement range	20 div (display range: 10 div)
Number of input channels	2
Input coupling settings	AC, DC, GND
Maximum sample rate	10 MS/s
Input type	Isolated unbalanced
Frequency characteristics ¹ (3 dB point a when sine wave of amplitude ±3 div is applied)	DC to 3 MHz
Voltage scale setting	5 mV/div to 20 V/div (1-2-5 steps) (when using 1:1 probe factor)
Maximum input voltage (at a frequency of 1 kHz or less)	Combined with the 700929 (10:1), 702902 (10:1), or 701947 (100:1): ² 800 V (DC+ACpeak) Combined with the 701901 + 701954 (1:1): ⁴ 200 V (DC+ACpeak) (as a value that meets the safety standard) 250 V (DC+ACpeak) (maximum allowable voltage, as a value that does not damage the instrument when applied) Direct input (cable that does not comply with the safety standards): ⁶ 42 V (DC+ACpeak)
maximum rated voltage to ground Between input and case Between inputs (at a frequency of 1 kHz or less)	Working voltage of safety standard Combined with 700929 (10:1), 702902 (10:1), 701947 (100:1) ³ or combined with 701901 + 701954 (1:1): ⁵ 400 Vrms (CAT II) Direct input (cable that does not comply with the safety standards): ⁷ 42 V (DC+ACpeak) (CAT II, 30 Vrms)
Vertical (voltage) axis accuracy DC accuracy ¹	±(0.5 % of 10 div)
Input connector	BNC connector (isolated type)
Input impedance	1 MΩ ±1 %, approx. 35 pF
3 dB point when AC coupled	10 Hz or less (1 Hz or less when using the 700929 or 702902, 0.1 Hz or less when using the 701947)
Common mode rejection ratio	80 dB (50/60 Hz) or more (typical value ⁸)
Residual noise level (input section shorted)	±400 μV or ±0.06 div whichever is greater (typical value ⁸)
Withstand voltage	2300 Vrms for 2 seconds (across each input terminal and earth)
Insulation resistance	500 VDC, 10 MΩ or more (across each input terminal and earth)
A/D converter resolution	12 bits (150 LSB/div)
Temperature coefficient	Zero point: ±(0.05 % of 10 div)/°C (typical value ⁸) Gain: ±0.02%/°C (typical value ⁸)
Bandwidth limit	Select from Full, 500 kHz, 50 kHz, 5 kHz, 500 Hz Cutoff characteristics: -18 dB/OCT (typical value ⁸)
Probe attenuation settings	Voltage probe: 1:1, 10:1, 100:1, 1000:1 Current probe: 1 A:1 V, 10 A:1 V, 100 A:1 V Clamp-on probe: 1 A:10 mV, 1 A:2.5 mV

1 Value measured under standard operating conditions

Combined with the 700929, 702902, or 701947

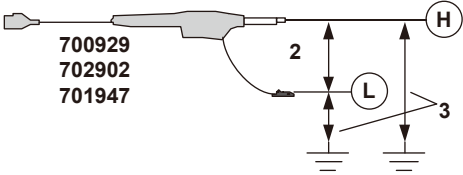

Combined with the 701901 and 701954

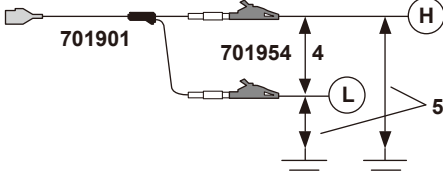

Direct input (cable that does not comply with the safety standards)

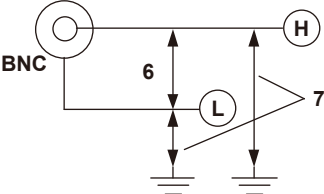

8 Typical values represent typical or average values. They are not strictly warranted.

7.15 Module Specifications

High-Speed High-Resolution 1 MS/s, 16-Bit Isolation Module (701251)

Item	Specifications
Standard operating conditions	Temperature: 23 ±5 °C Humidity: 20 to 80 % RH After a 30 minute warm-up and after calibration
Effective measurement range	20 div (display range: 10 div)
Number of input channels	2
Input coupling settings	AC, DC, GND
Maximum sample rate	1 MS/s
Input type	Isolated unbalanced
Frequency characteristics ¹ (-3 dB point when a sine wave of amplitude ±3 div is applied)	5 mV/div to 20 V/div: DC to 300 kHz 2 mV/div, 1 mV/div: DC to 200 kHz
Voltage scale setting	1 mV/div to 20 V/div (1-2-5 steps) (when using 1:1 probe factor)
Maximum input voltage (at a frequency of 1 kHz or less)	Combined with the 700929 (10:1), 702902 (10:1), or 701947 (100:1): ² 600 V (DC+ACpeak) Combined with the 701901 + 701954 (1:1): ⁴ 140 V (DC+ACpeak) Direct input (cable that does not comply with the safety standards): ⁶ 42 V (DC+ACpeak)
maximum rated voltage to ground Between input and case Maximum each input (at a frequency of 1 kHz or less)	Working voltage of safety standard Combined with 700929 (10:1), 702902 (10:1), 701947 (100:1) ³ or combined with 701901 + 701954 (1:1): ⁵ 300 Vrms CAT II, 400 Vrms (measurement category Other (O) 1500 V transient overvoltage) Direct input (cable that does not comply with the safety standards): ⁷ 42 V (DC+ACpeak) (CAT II, 30 Vrms)
Vertical (voltage) axis accuracy	5 mV/div to 20 V/div: ±(0.25 % of 10 div) 2 mV/div: ±(0.3 % of 10 div)
DC accuracy ¹	1 mV/div: ±(0.5 % of 10 div)
Input connector	BNC connector (isolated type)
Input impedance	1 MΩ ±1 %, approx. 35 pF
3 dB point when AC coupled	1 Hz or less (0.1 Hz or less when using the 700929 or 702902, 0.01 Hz or less when using the 701947)
Common mode rejection ratio	80 dB (50/60 Hz) or more (typical value ⁸)
Residual noise level (input section shorted)	±100 μV or ±0.01 div whichever is greater (typical value ⁸)
Withstand voltage	2300 Vrms for 2 seconds (across each input terminal and earth) (60 Hz)
Insulation resistance	500 VDC, 10 MΩ or more (across each input terminal and earth)
A/D converter resolution	16 bits (2400 LSB/div)
Temperature coefficient	Zero point: 5 mV/div to 20 V/div: ±(0.02 % of 10 div)/°C (typical value ⁸) 2 mV/div: ±(0.05 % of 10 div)/°C (typical value ⁸) 1 mV/div: ±(0.10 % of 10 div)/°C (typical value ⁸) Gain: 1 mV/div to 20 V/div: ±0.02%/°C (typical value ⁸)
Bandwidth limit	Select from Full, 40 kHz, 4 kHz, 400 Hz Cutoff characteristics: -12 dB/OCT (typical value ⁸)
Probe attenuation settings	Voltage probe: 1:1, 10:1, 100:1, 1000:1 Current probe: 1 A:1 V, 10 A:1 V, 100 A:1 V Clamp-on probe: 1 A:10 mV, 1 A:2.5 mV

1 Value measured under standard operating conditions

Combined with the 700929, 702902, or 701947

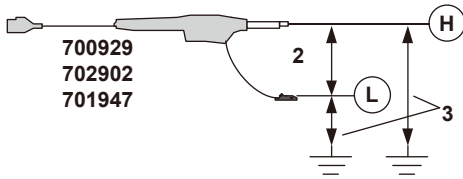

Combined with the 701901 and 701954

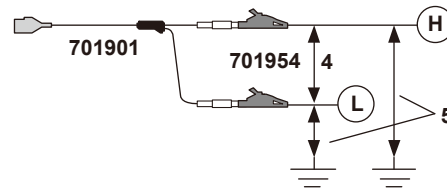

Direct input (cable that does not comply with the safety standards)

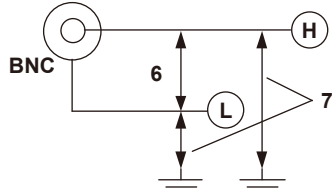

8 Typical values represent typical or average values. They are not strictly warranted.

High-Speed 10 MS/s, 12-Bit Non-Isolation Module (701255)

Item	Specifications
Standard operating conditions	Temperature: 23 °C ±5 °C Humidity: 20 % to 80 % RH After a 30 minute warm-up and after calibration
Effective measurement range	20 div (display range: 10 div)
Number of input channels	2
Input coupling settings	AC, DC, GND
Maximum sample rate	10 MS/s
Input type	Non-isolated unbalanced
Frequency characteristics ¹ (-3 dB point a when sine wave of amplitude ±3 div is applied)	DC to 3 MHz
Voltage scale setting	5 mV/div to 20 V/div (1-2-5 steps) (when using 1:1 probe factor)
Maximum input voltage (at a frequency of 1 kHz or less)	Combined with the 701940 (10:1): ² 600 V (DC+ACpeak) Direct Input: ³ 200 V (DC+ACpeak) (as a value that meets the safety standard) 250 V (DC+ACpeak) (maximum allowable voltage, as a value that does not damage the instrument when applied)
Vertical (voltage) axis accuracy DC accuracy ¹	±(0.5 % of 10 div)
Input connector	BNC connector (metal type)
Input impedance	1 MΩ ±1 %, approx. 35 pF
3 dB point when AC coupled	10 Hz or less (1 Hz or less when the 701940 is in use)
Residual noise level (input section shorted)	±400 μV or ±0.06 div whichever is greater (typical value ⁴)
A/D converter resolution	12 bits (150 LSB/div)
Temperature coefficient	Zero point: ±(0.05 % of 10 div)/°C (typical value ⁴) Gain: ±0.02%/°C (typical value ⁴)
Bandwidth limit	Select from Full, 500 kHz, 50 kHz, 5 kHz, 500 Hz Cutoff -18 dB/OCT (typical value ⁴) characteristics:
Probe attenuation settings	Voltage probe: 1:1, 10:1, 100:1, 1000:1 Current probe: 1 A:1 V, 10 A:1 V, 100 A:1 V Clamp-on probe: 1 A:10 mV, 1 A:2.5 mV

1 Value measured under standard operating conditions

Recommended:

With the 10:1 passive probe (701940)

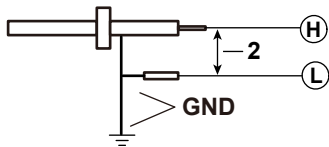

GND is connected to the case potential.

Direct input

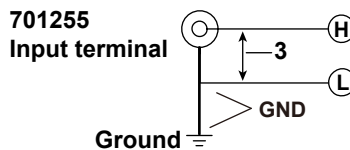

GND is connected to the case potential.

4 Typical values represent typical or average values. They are not strictly warranted.

High-Voltage 1 MS/s 16-Bit Isolation Module (with AAF and RMS) (720268)

Item	Specifications	
Standard operating conditions	Temperature: 23 ±5 °C Humidity: 20 to 80 % RH After a 30 minute warm-up and after calibration	
Effective measurement range	20 div (display range: 10 div)	
Number of input channels	2	
Input coupling settings	AC, DC, GND, AC-RMS, DC-RMS	
Maximum sample rate	1 MS/s	
Input type	Isolated unbalanced	
Frequency characteristics ¹ (-3 dB point a when sine wave of amplitude ±3 div is applied)	Waveform observation mode: DC to 300 kHz RMS observation mode: DC, 40 Hz to 100 kHz	
Voltage scale setting	20 mV/div to 200 V/div (1-2-5 steps)	
Maximum input voltage (at a frequency of 1 kHz or less)	Combined with the 758933 + 701954 or combined with the 701904 + 701954: ^{2, 7} Direct input (cable that does not comply with the safety standards): ⁴	1000 Vrms, but 1000 VDC or 1414 Vpeak MAX 42 V (DC+ACpeak)
maximum rated voltage to ground	Combined with the 758933 + 701954 or Combined with the 701904 + 701954: ³	1000 Vrms (CAT II), 600 Vrms (CAT III)
Between input and case Between inputs (at a frequency of 1 kHz or less)	Direct input (cable that does not comply with the safety standards) ⁵	42 V (DC+ACpeak) (CAT II, 30 Vrms)
Vertical (voltage) axis accuracy ¹	Waveform observation mode DC accuracy RMS observation mode DC accuracy AC accuracy (when a sine wave is input) AC accuracy (when the crest factor is 2 or less) AC accuracy (when the crest factor is 3 or less)	±(0.25 % of 10 div) ±(1.0 % of 10 div) ±(1.5 % of 10 div) 40 Hz to 10 kHz range ±(2.0 % of 10 div) 40 Hz to 10 kHz range ±(3.0 % of 10 div) 40 Hz to 10 kHz range For 1 kHz to 10 kHz, add +1.0 % to the above accuracy.
Input connector	Plug-in terminal (safety terminal)	
Input impedance	2 MΩ ±1%, approx. 12 pF	
3 dB point when AC coupled	1 Hz or less	
Common mode rejection ratio	80 dB (50/60 Hz) or more (typical value ⁶)	
Residual noise level (input section shorted)	±2 mV or ±0.04 div, whichever is greater (typical value ⁶)	
Withstand voltage	5400 Vrms for 2 seconds (across each input terminal and earth) (60 Hz)	
Insulation resistance	500 VDC, 10 MΩ or more (across each input terminal and earth)	
A/D converter resolution	16 bits (2400 LSB/div)	
Temperature coefficient (for waveform observation)	Zero point: ±(0.02 % of 10 div)/°C (typical value ⁶) Gain: ±0.02%/°C (typical value ⁶)	
Response time (for RMS observation)	Rising (0 to 90 % of 10 div): Falling (100 to 10 % of 10 div):	120 ms (typical value ⁶) 280 ms (typical value ⁶)
Bandwidth limit	Select from FULL, 40 kHz, 4 kHz, 400 Hz, AUTO Cutoff characteristics: AUTO: Digital filter Cutoff frequency (fc) for AUTO	
	Sample rate	Cutoff frequency (fc)
	100 kS/s or more	40 kHz
	100 S/s to 50 kS/s	40 % of the sample rate
	50 S/s or less	40 Hz
Crest factor (for RMS measurement only)	3 or less	

7.15 Module Specifications

Item	Specifications
Cutoff frequency characteristics of the anti-aliasing filter (AAF)	When the filter is set to AUTO, the anti-aliasing filter (AAF) and low-pass filter are automatically set according to the sample rate.

Sample rate	AAF	Low-Pass Filter
1 MS/s	40 kHz	40 kHz
500 kHz	40 kHz	40 kHz
200 kHz	40 kHz	40 kHz
100 kS/s	40 kHz	40 kHz
50 kS/s	20 kHz	40 kHz
20 kS/s	8 kHz	40 kHz
10 kS/s	4 kHz	4 kHz
5 kS/s	2 kHz	4 kHz
2 kS/s	800 Hz	4 kHz
1 kS/s	400 Hz	400 Hz
500 S/s	200 Hz	400 Hz
200 S/s	80 Hz	400 Hz
100 S/s	40 Hz	400 Hz
50 S/s or less	40 Hz	400 Hz
Ext sample	OFF	OFF

- 1 Value measured under standard operating conditions

With the 758933 and 701954, with the 701904 and 701954

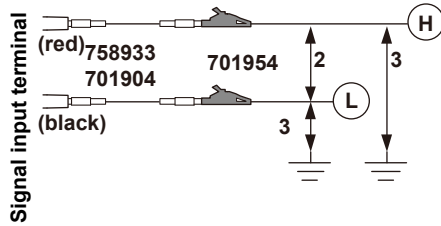

Direct input (cable that does not comply with the safety standards)

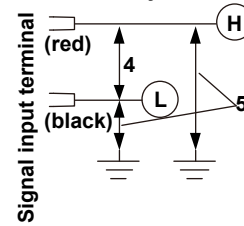

- 6 Typical values represent typical or average values. They are not strictly warranted.
 7 850 V (DC+ACpeak) when used on the DL850, DL850V, DL850E, DL850EV, or SL1000.

Universal (Voltage/Temp.) Module (701261), Universal (Voltage/Temp.) Module (with AAF) (701262)

Item	Specifications																																	
Standard operating conditions	Temperature: 23 ±5 °C Humidity: 20 to 80 % RH After a 30 minute warm-up and after calibration																																	
Function	Temperature (thermocouple) or voltage measurement (switchable)																																	
Effective measurement range	[Voltage measurement] 20 div (display range: 10 div)																																	
Number of input channels	2																																	
Input coupling settings	TC, DC, AC, GND TC: Temperature (thermocouple) measurement DC: Voltage measurement (DC coupling) AC: Voltage measurement (AC coupling)																																	
When Measuring Voltage Maximum sampling rate	100 kS/s																																	
Temperature measurement data update rate	500 Hz																																	
Input type	Isolated unbalanced																																	
Measurement range/ accuracy ¹	[Voltage measurement]	Voltage scale: 5 mV/div to 20 V/div (1-2-5 steps) Voltage accuracy: ±(0.25 % of 10 div)																																
	[Temperature measurement] ²																																	
Thermocouple standards • K, E, J, T, N, R, S, B: IEC 60584-1 DIN IEC 60584-1 JIS C1602 • W : W-5 %Re/W-26 %Re (Hoskins Mfg. Co.) ASTM E988 • L: Fe-CuNi, DIN43710 • U: Cu-CuNi, DIN43710	<table border="1"> <thead> <tr> <th>Type</th> <th>Measurement Range</th> <th>Accuracy</th> </tr> </thead> <tbody> <tr> <td>K</td> <td>-200 to 1300 °C</td> <td rowspan="5">±(0.1 % of reading + 1.5 °C) Except ±(0.2 % of reading + 1.5 °C) for -200 °C to 0 °C</td> </tr> <tr> <td>E</td> <td>-200 to 800 °C</td> </tr> <tr> <td>J</td> <td>-200 to 1100 °C</td> </tr> <tr> <td>T</td> <td>-200 to 400 °C</td> </tr> <tr> <td>L</td> <td>-200 to 900 °C</td> </tr> <tr> <td>U</td> <td>-200 to 400 °C</td> <td rowspan="3">±(0.1 % of reading + 3 °C) Except, 0 to 200 °C: ±8 °C 200 to 800 °C: ±5 °C</td> </tr> <tr> <td>N</td> <td>0 to 1300 °C</td> </tr> <tr> <td>R</td> <td>0 to 1700 °C</td> </tr> <tr> <td>S</td> <td>0 to 1700 °C</td> <td rowspan="2">±(0.1 % of reading + 2 °C) Except, 400 to 700 °C: ±8 °C Effective range is 400 to 1800 °C</td> </tr> <tr> <td>B</td> <td>0 to 1800 °C</td> </tr> <tr> <td>W</td> <td>0 to 2300 °C</td> <td>±(0.1 % of reading + 3 °C)</td> </tr> <tr> <td>Au7Fe³</td> <td>0 to 300 K</td> <td>0 to 50 K: ±4 K 50 to 300 K: ±2.5 K</td> </tr> </tbody> </table>	Type	Measurement Range	Accuracy	K	-200 to 1300 °C	±(0.1 % of reading + 1.5 °C) Except ±(0.2 % of reading + 1.5 °C) for -200 °C to 0 °C	E	-200 to 800 °C	J	-200 to 1100 °C	T	-200 to 400 °C	L	-200 to 900 °C	U	-200 to 400 °C	±(0.1 % of reading + 3 °C) Except, 0 to 200 °C: ±8 °C 200 to 800 °C: ±5 °C	N	0 to 1300 °C	R	0 to 1700 °C	S	0 to 1700 °C	±(0.1 % of reading + 2 °C) Except, 400 to 700 °C: ±8 °C Effective range is 400 to 1800 °C	B	0 to 1800 °C	W	0 to 2300 °C	±(0.1 % of reading + 3 °C)	Au7Fe ³	0 to 300 K	0 to 50 K: ±4 K 50 to 300 K: ±2.5 K	
Type	Measurement Range	Accuracy																																
K	-200 to 1300 °C	±(0.1 % of reading + 1.5 °C) Except ±(0.2 % of reading + 1.5 °C) for -200 °C to 0 °C																																
E	-200 to 800 °C																																	
J	-200 to 1100 °C																																	
T	-200 to 400 °C																																	
L	-200 to 900 °C																																	
U	-200 to 400 °C	±(0.1 % of reading + 3 °C) Except, 0 to 200 °C: ±8 °C 200 to 800 °C: ±5 °C																																
N	0 to 1300 °C																																	
R	0 to 1700 °C																																	
S	0 to 1700 °C	±(0.1 % of reading + 2 °C) Except, 400 to 700 °C: ±8 °C Effective range is 400 to 1800 °C																																
B	0 to 1800 °C																																	
W	0 to 2300 °C	±(0.1 % of reading + 3 °C)																																
Au7Fe ³	0 to 300 K	0 to 50 K: ±4 K 50 to 300 K: ±2.5 K																																
Frequency characteristics ¹ (-3 dB point when a sine wave of amplitude ±3 div is applied)	[Voltage measurement]	DC to 40 kHz																																
	[Temperature measurement]	DC to 100 Hz																																
Maximum input voltage ⁴ (at a frequency of 1 kHz or less)	Both temperature and voltage input:	42 V (DC+ACpeak) (as a value that meets the safety standard) 150 V (DC+ACpeak) (maximum allowable voltage, as a value that does not damage the instrument when applied)																																
Maximum rated voltage to ground ⁵ Between input and case Between inputs (at a frequency of 1 kHz or less)	Both temperature and voltage input:	42 V (DC+ACpeak) (CAT II, 30 Vrms)																																
Vertical resolution	[Voltage measurement]	During voltage input: 2400 LSB/div																																
	[Temperature measurement]	When measuring temperature: 0.1 °C																																
3 dB point when AC coupled	[Voltage measurement]	0.5 Hz or less																																
Input connector	Binding post																																	
Input impedance	Approx. 1 MΩ																																	

7.15 Module Specifications

Item	Specifications		
Common mode rejection ratio	[Voltage measurement]	80 dB or more (50/60 Hz) (typical value ⁶)	
	[Temperature measurement]	120 dB or more (50/60 Hz, with 2-Hz filter ON, signal source resistance of 500 Ω or less) (typical value ⁶)	
Residual noise level (input section shorted)	[Voltage measurement]	±100 μV or ±0.01 div whichever is greater (typical value ⁶)	
A/D converter resolution	[Voltage measurement]	16 bits (2400 LSB/div)	
Temperature coefficient	[Voltage measurement]	Zero point: ±(0.01 % of 10 div)/°C (typical value ⁶)	
		Gain: ±0.02%/°C (typical value ⁶)	
Reference junction compensation accuracy (when the input terminal temperature is balanced)	K, E, J, T, L, U, N:	±1 °C	
	R, S, B, W:	±1.5 °C	
	Au7Fe:	±1 K	
Bandwidth limit	[Temperature measurement]	(Digital filter + analog filter) Select from Full, 30 Hz, 8 Hz, and 2 Hz + 150 Hz secondary analog filter	
	[Voltage measurement]	Select from Full, AUTO, 4 kHz, 400 Hz, 40 Hz Cutoff characteristics: -12 dB/OCT (typical value, ⁶ setting other than AUTO)	
	Cutoff frequency (fc) when set to AUTO (701262 only)		
	Sample rate	Cutoff frequency (fc)	
	100 kS/s or more	40 kHz	
	100 S/s to 50 kS/s	40 % of the sample rate	
	50 S/s or less	20 Hz	
	Cutoff characteristics for AUTO: -65 dB at 2 × fc (typical value ⁶)		
Table of cutoff frequency characteristics of the anti-aliasing filter (AAF)	When the filter is set to Auto, the anti-aliasing filter and low-pass filter are automatically set according to the sample rate.		
	Sample rate	AAF	Low-Pass Filter
	100 kS/s	40 kHz	OFF
	50 kS/s	20 kHz	OFF
	20 kS/s	8 kHz	OFF
	10 kS/s	4 kHz	4 kHz
	5 kS/s	2 kHz	4 kHz
	2 kS/s	800 Hz	4 kHz
	1 kS/s	400 Hz	400 Hz
	500 S/s	200 Hz	400 Hz
	200 S/s	80 Hz	400 Hz
	100 S/s	40 Hz	40 Hz
	50 S/s	20 Hz	40 Hz
	20 S/s to 5 S/s	20 Hz	40 Hz
	2 S/s or less	20 Hz	40 Hz
	Ext sample	40 kHz	OFF

- 1 Value measured under standard operating conditions
- 2 Does not include the reference junction temperature compensation accuracy.
- 3 This module supports Au7Fe with 0.07 % metal content with respect to gold.

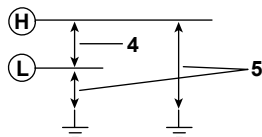

- 6 Typical values represent typical or average values. They are not strictly warranted.

Temperature, High Precision Voltage Isolation Module (701265)

Item	Specifications		
Standard operating conditions	Temperature: 23 ±5 °C Humidity: 20 to 80 % RH After a 30 minute warm-up and after calibration		
Function	Temperature (thermocouple) or voltage measurement (switchable)		
Effective measurement range	[Voltage measurement] 20 div (display range: 10 div)		
Number of input channels	2		
Input coupling settings	TC, DC, GND TC: Temperature (thermocouple) measurement DC: Voltage measurement (DC coupling)		
Data update rate	500 Hz		
Input type	Isolated unbalanced		
Measurement range/accuracy ¹	[Voltage measurement]	Voltage scale: Voltage accuracy:	100 µV/div to 10 V/div (1-2-5 steps) ±(0.08 % of 10 div + 2 µV)
For the thermocouple standards, see the 701261 specifications.	[Temperature measurement] ²		
		Type	Measurement Range
		K	-200 to 1300 °C
		E	-200 to 800 °C
		J	-200 to 1100 °C
		T	-200 to 400 °C
		L	-200 to 900 °C
		U	-200 to 400 °C
		N	0 to 1300 °C
		R	0 to 1700 °C
	S	0 to 1700 °C	
	B	0 to 1800 °C	
	W	0 to 2300 °C	
	Au7Fe ³	0 to 300 K	
		0 to 50 K: ±4 K 50 to 300 K: ±2.5 K	
Frequency characteristics ¹ (-3 dB point when a sine wave of amplitude ±3 div is applied)	[Voltage measurement]	DC to 100 Hz	
	[Temperature measurement]	DC to 100 Hz	
Maximum input voltage ⁴ (at a frequency of 1 kHz or less)	Both temperature and voltage input:		42 V (DC+ACpeak)
Maximum rated voltage to ground ⁵ Between input and case Between inputs (at a frequency of 1 kHz or less)	Both temperature and voltage input:		42 V (DC+ACpeak) (CAT II, 30 Vrms)
Vertical resolution	[Voltage measurement]	During voltage input:	2400 LSB/div
	[Temperature measurement]	When measuring temperature:	0.1 °C
3 dB point when AC coupled	[Voltage measurement]	0.5 Hz or less	
Input connector	Binding post		
Input impedance	Approx. 1 MΩ		
Common mode rejection ratio	[Voltage measurement]	80 dB or more (50/60 Hz) (typical value ⁶)	
	[Temperature measurement]	120 dB or more (50/60 Hz, with 2-Hz filter ON, signal source resistance of 500 Ω or less) (typical value ⁶)	
Residual noise level (input section shorted)	[Voltage measurement]	±4 µV or ±0.01 div whichever is greater (typical value ⁶)	
A/D converter resolution	[Voltage measurement]	16 bits (2400 LSB/div)	

7.15 Module Specifications

Item	Specifications		
Temperature coefficient	[Voltage measurement]	Zero point:	$\pm(0.01\% \text{ of } 10 \text{ div})/^{\circ}\text{C} + 0.05 \mu\text{V}/^{\circ}\text{C}$ (typical value ⁶)
		Gain:	$\pm 0.02\%/^{\circ}\text{C}$ (typical value ⁶)
Reference junction compensation accuracy (when the input terminal temperature is balanced)	K, E, J, T, L, U, N: R, S, B, W: Au7Fe:	$\pm 1^{\circ}\text{C}$ $\pm 1.5^{\circ}\text{C}$ $\pm 1 \text{ K}$	
Bandwidth limit (Digital filter)	Select from Full, 30 Hz, 8 Hz, 2 Hz		
Input bias current	20 nA or less The zero point of this module appears to be offset when the input is open due to the effects of the bias current, but this is not a malfunction. Connect the input to the device under measurement.		

- 1 Value measured under standard operating conditions
- 2 Does not include the reference junction temperature compensation accuracy.
- 3 This module supports Au7Fe with 0.07 % metal content with respect to gold.

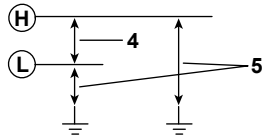

- 6 Typical values represent typical or average values. They are not strictly warranted.

Temperature, High Precision Voltage Isolation Module (low noise) (720266)

Item	Specifications		
Standard operating conditions	Temperature: 23 ±5 °C Humidity: 20 to 80 % RH After a 30 minute warm-up and after calibration		
Function	Temperature (thermocouple) or voltage measurement (switchable)		
Effective measurement range	[Voltage measurement] 20 div (display range: 10 div)		
Number of input channels	2		
Input coupling settings	TC, DC, GND TC: Temperature (thermocouple) measurement DC: Voltage measurement (DC coupling)		
Data update rate	Approx. 125 Hz		
Input type	Isolated unbalanced		
Measurement range/accuracy ¹	[Voltage measurement]	Voltage scale:	100 µV/div to 20 V/div (1-2-5 steps)
		Voltage accuracy:	±(0.08 % of 10 div + 2 µV)
For the thermocouple standards, see the 701261 specifications.	[Temperature measurement] ²		
	Type	Measurement Range	Accuracy
	K	-200 to 1300 °C	
	E	-200 to 800 °C	±(0.1 % of reading + 1.5 °C)
	J	-200 to 1100 °C	Except ±(0.2 % of reading + 1.5 °C) for -200 °C to 0 °C
	T	-200 to 400 °C	
	L	-200 to 900 °C	
	U	-200 to 400 °C	
	N	0 to 1300 °C	
	R	0 to 1700 °C	±(0.1 % of reading + 3 °C)
	S	0 to 1700 °C	Except, 0 to 200 °C: ±8 °C 200 to 800 °C: ±5 °C
	B	0 to 1800 °C	±(0.1 % of reading + 2 °C) Except, 400 to 700 °C: ±8 °C Effective range is 400 to 1800 °C
	W	0 to 2300 °C	±(0.1 % of reading + 3 °C)
	Au7Fe ³	0 to 300 K	0 to 50 K: ±4 K 50 to 300 K: ±2.5 K
Frequency characteristics ¹ (-3 dB point when a sine wave of amplitude ±3 div is applied)	[Voltage measurement]	DC to 15 Hz	
	[Temperature measurement]	DC to 15 Hz	
Maximum input voltage ⁴ (at a frequency of 1 kHz or less)	Both temperature and voltage input:		42 V (DC+ACpeak)
Maximum rated voltage to ground ⁵ Between input and case Between inputs (at a frequency of 1 kHz or less)	Both temperature and voltage input:		42 V (DC+ACpeak) (CAT II, 30 Vrms)
Vertical resolution	[Voltage measurement]	During voltage input:	2400 LSB/div
	[Temperature measurement]	When measuring temperature:	0.1 °C
Input connector	Binding post		
Input impedance	Approx. 1 MΩ		
Common mode rejection ratio	[Voltage measurement]	80 dB or more (50/60 Hz) (typical value ⁶)	
	[Temperature measurement]	120 dB or more (50/60 Hz, with 1-Hz filter ON, signal source resistance of 500 Ω or less) (typical value ⁶)	
Residual noise level (input section shorted)	[Voltage measurement]	±4 µV or ±0.01 div whichever is greater (typical value ⁶)	
A/D converter resolution	[Voltage measurement]	16 bits (2400 LSB/div)	

7.15 Module Specifications

Item	Specifications
Temperature coefficient	[Voltage measurement] Zero point: $\pm(0.01\% \text{ of } 10 \text{ div})/^{\circ}\text{C} + 0.05 \mu\text{V}/^{\circ}\text{C}$ (typical value ⁶) Gain: $\pm 0.02\%/^{\circ}\text{C}$ (typical value ⁶)
Reference junction compensation accuracy (when the input terminal temperature is balanced)	K, E, J, T, L, U, N: $\pm 1^{\circ}\text{C}$ R, S, B, W: $\pm 1.5^{\circ}\text{C}$ Au7Fe: $\pm 1 \text{ K}$
Bandwidth limit	Line filter: 15 Hz Cutoff characteristics: -6 dB/OCT (typical value ⁶) Digital filter, select from Full, 8 Hz, 1 Hz, 0.1 Hz Cutoff characteristics: -24 dB/Oct
Input bias current	20 nA or less The zero point of this module appears to be offset when the input is open due to the effects of the bias current, but this is not a malfunction. Connect the input to the device under measurement.

- 1 Value measured under standard operating conditions
- 2 Does not include the reference junction temperature compensation accuracy.
- 3 This module supports Au7Fe with 0.07 % metal content with respect to gold.

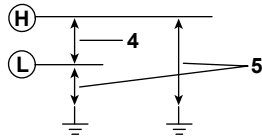

- 6 Typical values represent typical or average values. They are not strictly warranted.

Strain Module (NDIS) (701270)

Item	Specifications																												
Standard operating conditions	Temperature: 23 ±5 °C Humidity: 20 to 80 % RH After a 30 minute warm-up and after calibration and auto balance																												
Effective measurement range	-FS to +FS (set using upper and lower limits)																												
Number of input channels	2																												
Maximum sample rate	100 kS/s																												
Input type	DC bridge (auto balancing), balanced differential input, and isolated																												
Auto balance type	Electronic auto balance																												
Auto balance range	±10000 μSTR (1 gauge method)																												
Bridge voltage	Select from 2 V, 5 V, 10 V																												
Gauge resistance	120 Ω to 1000 Ω (bridge voltage: 2 V) 350 Ω to 1000 Ω (bridge voltage: 2 V, 5 V, 10 V)																												
Gauge factor	1.90 to 2.20 (set in 0.01 steps)																												
Frequency characteristics ¹ (-3 dB point a when sine wave of amplitude ±3 div is applied)	DC to 20 kHz																												
mV/V range support	Supports the strain gauge transducer unit system. mV/V range = 0.5×(μSTR range/1000)																												
Measurement range (FS) and measurement range	When using STR range <table border="1" data-bbox="518 918 1018 1149"> <thead> <tr> <th>Measurement Range (FS)</th> <th>Measurement Range</th> </tr> </thead> <tbody> <tr> <td>500 μSTR</td> <td>-500 μSTR to + 500 μSTR</td> </tr> <tr> <td>1000 μSTR</td> <td>-1000 μSTR to + 1000 μSTR</td> </tr> <tr> <td>2000 μSTR</td> <td>-2000 μSTR to + 2000 μSTR</td> </tr> <tr> <td>5000 μSTR</td> <td>-5000 μSTR to + 5000 μSTR</td> </tr> <tr> <td>10000 μSTR</td> <td>-10000 μSTR to + 10000 μSTR</td> </tr> <tr> <td>20000 μSTR</td> <td>-20000 μSTR to + 20000 μSTR</td> </tr> </tbody> </table> When using mV/V range <table border="1" data-bbox="518 1193 1018 1424"> <thead> <tr> <th>Measurement Range (FS)</th> <th>Measurement Range</th> </tr> </thead> <tbody> <tr> <td>0.25 mV/V</td> <td>-0.25 mV/V to + 0.25 mV/V</td> </tr> <tr> <td>0.5 mV/V</td> <td>-0.5 mV/V to + 0.5 mV/V</td> </tr> <tr> <td>1 mV/V</td> <td>-1 mV/V to + 1 mV/V</td> </tr> <tr> <td>2.5 mV/V</td> <td>-2.5 mV/V to + 2.5 mV/V</td> </tr> <tr> <td>5 mV/V</td> <td>-5 mV/V to + 5 mV/V</td> </tr> <tr> <td>10 mV/V</td> <td>-10 mV/V to + 10 mV/V</td> </tr> </tbody> </table>	Measurement Range (FS)	Measurement Range	500 μSTR	-500 μSTR to + 500 μSTR	1000 μSTR	-1000 μSTR to + 1000 μSTR	2000 μSTR	-2000 μSTR to + 2000 μSTR	5000 μSTR	-5000 μSTR to + 5000 μSTR	10000 μSTR	-10000 μSTR to + 10000 μSTR	20000 μSTR	-20000 μSTR to + 20000 μSTR	Measurement Range (FS)	Measurement Range	0.25 mV/V	-0.25 mV/V to + 0.25 mV/V	0.5 mV/V	-0.5 mV/V to + 0.5 mV/V	1 mV/V	-1 mV/V to + 1 mV/V	2.5 mV/V	-2.5 mV/V to + 2.5 mV/V	5 mV/V	-5 mV/V to + 5 mV/V	10 mV/V	-10 mV/V to + 10 mV/V
Measurement Range (FS)	Measurement Range																												
500 μSTR	-500 μSTR to + 500 μSTR																												
1000 μSTR	-1000 μSTR to + 1000 μSTR																												
2000 μSTR	-2000 μSTR to + 2000 μSTR																												
5000 μSTR	-5000 μSTR to + 5000 μSTR																												
10000 μSTR	-10000 μSTR to + 10000 μSTR																												
20000 μSTR	-20000 μSTR to + 20000 μSTR																												
Measurement Range (FS)	Measurement Range																												
0.25 mV/V	-0.25 mV/V to + 0.25 mV/V																												
0.5 mV/V	-0.5 mV/V to + 0.5 mV/V																												
1 mV/V	-1 mV/V to + 1 mV/V																												
2.5 mV/V	-2.5 mV/V to + 2.5 mV/V																												
5 mV/V	-5 mV/V to + 5 mV/V																												
10 mV/V	-10 mV/V to + 10 mV/V																												
DC accuracy ¹	±(0.5 % of FS + 5 μSTR)																												
Maximum input voltage (at a frequency of 1 kHz or less)	Between Input+ and Input-: 10 V (DC+ACpeak)																												
Maximum rated voltage to ground Between input and case Between inputs (at a frequency of 1 kHz or less)	Between each terminal and earth ground: 42 V (DC+ACpeak) (CAT II, 30 Vrms)																												
Input connector	NDIS connector (Recommended by JSNDI (The Japanese Society for Non-destructive Inspection))																												
Common mode rejection ratio	80 dB (50 Hz/60 Hz) or more (typical value ²)																												
A/D converter resolution	16 bit (4800 LSB/div ±FS: Upper = +FS, Lower = -FS)																												
Temperature coefficient	Zero point: ±5 μSTR/ °C (typical value ²) Gain: ±0.02%/°C (typical value ²)																												
Bandwidth limit	Select from Full, 1 kHz, 100 Hz, 10 Hz Cutoff -12 dB/OCT (typical value ²) characteristics:																												
Function	mV/V support. Supports the strain gauge transducer unit system.																												
Standard accessories	NDIS connector (for external connection: PRC03-12A10-7M10.5 by Tajimi) A1002JC: 2 pieces																												

7.15 Module Specifications

Item	Specifications
Compatible accessories (sold separately)	Recommended bridge head 701955 (NDIS 120 Ω , enhanced shield version, comes with a 5-m cable) Recommended bridge head 701956 (NDIS 350 Ω , enhanced shield version, comes with a 5-m cable)
Notes	<ul style="list-style-type: none"> Highly sensitive measurements are made in the μV level in strain measurements. Therefore, take measures against noise at the strain sensor perimeter, bridge head, and cable wiring. Depending on the noise environment, an error may result in the balance. Check the influence before making measurements. The bridge head specified by YOKOGAWA has high noise resistance. Some of the strain gauge sensors and bridge heads made by other manufacturers do not have sensing wires connected. (No such problems with bridge heads made by YOKOGAWA.) If such products are used, an error may result in the bridge voltage leading to measurement errors, because sensing does not work effectively. Perform sensing as close to the bridge head as possible. The connector shell is connected to the case potential. When a bridge head (701955 or 701956) is used, the connector shell, cable shield, and the bridge head case are all connected to the case potential of the DL950. When a bridge head (701955 or 701956) is used, the connector shell, cable shield, and the bridge head case are all connected to the case potential of the instrument. Be sure to execute balancing again when you change the range or the bridge voltage.

- Value measured under standard operating conditions
- Typical values represent typical or average values. They are not strictly warranted.

Module front view

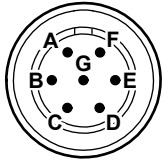

- A : Bridge+ (positive bridge voltage)**
- B : Input- (negative measurement signal)**
- C : Bridge- (negative bridge voltage)**
- D : Input+ (positive measurement signal)**
- E : Floating common**
- F : Sense+ (positive bridge voltage sensing)**
- G : Sense- (negative bridge voltage sensing)**

The connector shell is connected to the case potential.

Strain Module (DSUB, Shunt-Cal) (701271)

Item	Specifications																												
Standard operating conditions	Temperature: 23 ±5 °C Humidity: 20 to 80 % RH After a 30 minute warm-up and after calibration and auto balance																												
Effective measurement range	-FS to +FS (set using upper and lower limits)																												
Number of input channels	2																												
Maximum sample rate	100 kS/s																												
Input type	DC bridge (auto balancing), balanced differential input, and isolated																												
Auto balance type	Electronic auto balance																												
Auto balance range	±10000 µSTR (1 gauge method)																												
Bridge voltage	Select from 2 V, 5 V, 10 V																												
Gauge resistance	120 Ω to 1000 Ω (bridge voltage: 2 V) 350 Ω to 1000 Ω (bridge voltage: 2 V, 5 V, 10 V)																												
Gauge factor	1.90 to 2.20 (set in 0.01 steps)																												
Frequency characteristics ¹ (-3 dB point when a sine wave of amplitude ±3 div is applied)	DC to 20 kHz																												
mV/V range support	Supports the strain gauge transducer unit system. mV/V range = 0.5×(µSTR range/1000)																												
Measurement range (FS) and measurement range	When using STR range <table border="1" data-bbox="523 920 1027 1151"> <thead> <tr> <th>Measurement Range (FS)</th> <th>Measurement Range</th> </tr> </thead> <tbody> <tr> <td>500 µSTR</td> <td>-500 µSTR to + 500 µSTR</td> </tr> <tr> <td>1000 µSTR</td> <td>-1000 µSTR to + 1000 µSTR</td> </tr> <tr> <td>2000 µSTR</td> <td>-2000 µSTR to + 2000 µSTR</td> </tr> <tr> <td>5000 µSTR</td> <td>-5000 µSTR to + 5000 µSTR</td> </tr> <tr> <td>10000 µSTR</td> <td>-10000 µSTR to + 10000 µSTR</td> </tr> <tr> <td>20000 µSTR</td> <td>-20000 µSTR to + 20000 µSTR</td> </tr> </tbody> </table> When using mV/V range <table border="1" data-bbox="523 1196 1027 1426"> <thead> <tr> <th>Measurement Range (FS)</th> <th>Measurement Range</th> </tr> </thead> <tbody> <tr> <td>0.25 mV/V</td> <td>-0.25 mV/V to + 0.25 mV/V</td> </tr> <tr> <td>0.5 mV/V</td> <td>-0.5 mV/V to + 0.5 mV/V</td> </tr> <tr> <td>1 mV/V</td> <td>-1 mV/V to + 1 mV/V</td> </tr> <tr> <td>2.5 mV/V</td> <td>-2.5 mV/V to + 2.5 mV/V</td> </tr> <tr> <td>5 mV/V</td> <td>-5 mV/V to + 5 mV/V</td> </tr> <tr> <td>10 mV/V</td> <td>-10 mV/V to + 10 mV/V</td> </tr> </tbody> </table>	Measurement Range (FS)	Measurement Range	500 µSTR	-500 µSTR to + 500 µSTR	1000 µSTR	-1000 µSTR to + 1000 µSTR	2000 µSTR	-2000 µSTR to + 2000 µSTR	5000 µSTR	-5000 µSTR to + 5000 µSTR	10000 µSTR	-10000 µSTR to + 10000 µSTR	20000 µSTR	-20000 µSTR to + 20000 µSTR	Measurement Range (FS)	Measurement Range	0.25 mV/V	-0.25 mV/V to + 0.25 mV/V	0.5 mV/V	-0.5 mV/V to + 0.5 mV/V	1 mV/V	-1 mV/V to + 1 mV/V	2.5 mV/V	-2.5 mV/V to + 2.5 mV/V	5 mV/V	-5 mV/V to + 5 mV/V	10 mV/V	-10 mV/V to + 10 mV/V
Measurement Range (FS)	Measurement Range																												
500 µSTR	-500 µSTR to + 500 µSTR																												
1000 µSTR	-1000 µSTR to + 1000 µSTR																												
2000 µSTR	-2000 µSTR to + 2000 µSTR																												
5000 µSTR	-5000 µSTR to + 5000 µSTR																												
10000 µSTR	-10000 µSTR to + 10000 µSTR																												
20000 µSTR	-20000 µSTR to + 20000 µSTR																												
Measurement Range (FS)	Measurement Range																												
0.25 mV/V	-0.25 mV/V to + 0.25 mV/V																												
0.5 mV/V	-0.5 mV/V to + 0.5 mV/V																												
1 mV/V	-1 mV/V to + 1 mV/V																												
2.5 mV/V	-2.5 mV/V to + 2.5 mV/V																												
5 mV/V	-5 mV/V to + 5 mV/V																												
10 mV/V	-10 mV/V to + 10 mV/V																												
DC accuracy ¹	±(0.5 % of FS + 5 µSTR)																												
Maximum input voltage (at a frequency of 1 kHz or less)	Between Input+ and Input-: 10 V (DC+ACpeak)																												
Maximum rated voltage to ground Between input and case Between inputs (at a frequency of 1 kHz or less)	Between each terminal and earth ground: 42 V (DC+ACpeak) (CAT II, 30 Vrms)																												
Input connector	9-pin D-Sub connector (female)																												
Common mode rejection ratio	80 dB (50 Hz/60 Hz) or more (typical value ²)																												
A/D converter resolution	16 bit (4800 LSB/div ±FS: Upper = +FS, Lower = -FS)																												
Temperature coefficient	Zero point: ±5 µSTR/ °C (typical value ²) Gain: ±0.02%/°C (typical value ²)																												
Bandwidth limit	Select from Full, 1 kHz, 100 Hz, 10 Hz Cutoff characteristics: -12 dB/OCT (typical value ²)																												
Function	mV/V support. Supports the strain gauge transducer unit system. Shunt calibration support. Built-in shunt calibration relay (1 gauge method).																												

7.15 Module Specifications

Item	Specifications
Standard accessories	Connector shell set for soldering A1520JD (9-pin D-Sub): 2 pieces, A1618JD (connector shell): 2 pieces
Compatible accessories (sold separately)	Recommended bridge head 701957 (D-Sub 120 Ω, shunt-Cal, enhanced shield version, comes with a 5-m cable) Recommended bridge head 701958 (D-Sub 350 Ω, shunt-Cal, enhanced shield version, comes with a 5-m cable)
Notes	<ul style="list-style-type: none"> Highly sensitive measurements are made in the μV level in strain measurements. Therefore, take measures against noise at the strain sensor perimeter, bridge head, and cable wiring. Depending on the noise environment, an error may result in the balance. Check the influence before making measurements. The bridge head specified by YOKOGAWA has high noise resistance. When executing shunt calibration, be sure to calculate the shunt resistance in advance, and execute it in a range so that the measured values do not exceed the range even when the shunt resistance is ON. Some of the strain gauge sensors and bridge heads made by other manufacturers do not have sensing wires connected. (No such problems with bridge heads made by YOKOGAWA.) If such products are used, an error may result in the bridge voltage leading to measurement errors, because sensing does not work effectively. Perform sensing as close to the bridge head as possible. (There is no conversion cable for sensing on D-Sub connector types.) The connector shell is connected to the case potential. When a bridge head (701957 or 701958) is used, the connector shell, cable shield, and the bridge head case are all connected to the case potential of the DL950. When a bridge head (701957 or 701958) is used, the connector shell, cable shield, and the bridge head case are all connected to the case potential of the instrument. Be sure to execute balancing again when you change the range or the bridge voltage.

- Value measured under standard operating conditions
- Typical values represent typical or average values. They are not strictly warranted.

Module front view

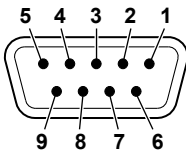

- 1 : Floating common
- 2 : Sense- (negative bridge voltage sensing)
- 3 : Shuntcal- (negative shunt signal)
- 4 : Shuntcal+ (positive shunt signal)
- 5 : Sense+ (positive bridge voltage sensing)
- 6 : Bridge- (negative bridge voltage)
- 7 : Input- (negative measurement signal)
- 8 : Input+ (positive measurement signal)
- 9 : Bridge+ (positive bridge voltage)

Acceleration/Voltage Module (with AAF) (701275)

Item	Specifications
Standard operating conditions	Temperature: 23 ±5 °C Humidity: 20 to 80 % RH After a 30 minute warm-up and after calibration
Effective measurement range	20 div (display range: 10 div)
Number of input channels	2
Input coupling settings	AC, DC, ACCL (acceleration), and GND
Maximum sample rate	100 kS/s
Input type	Isolated unbalanced
Frequency characteristics ¹ (-3 dB point when a sine wave of amplitude ±3 div is applied)	Waveform measurement mode: DC to 40 kHz Acceleration measurement mode: 0.4 Hz to 40 kHz
Voltage scale setting	5 mV/div to 10 V/div (1-2-5 steps) (when using 1:1 probe factor) Acceleration (±5 V = ×1 range): ×0.1 to ×1 to ×100 (1-2-5 steps)
Maximum input voltage (at a frequency of 1 kHz or less)	42 V (DC+ACpeak) ²
Maximum rated voltage to ground Between input and case Between inputs (at a frequency of 1 kHz or less)	Working voltage of safety standard 42 V (DC+ACpeak) (CAT II, 30 Vrms) ³
Vertical (voltage) axis accuracy	Waveform measurement mode DC accuracy: ±(0.25 % of 10 div) Acceleration measurement mode: ±(0.5 % of 10 div) at 1 kHz
Input connector	BNC connector (metal type)
Input impedance	1 MΩ ±1 %, approx. 35 pF
3 dB point when AC coupled	0.4 Hz or less (0.04 Hz or less when the 701940 is in use) (typical value ⁴)
Common mode rejection ratio	80 dB (50/60 Hz) or more (typical value ⁴)
Residual noise level (input section shorted)	±100 μV or ±0.01 div whichever is greater (typical value ⁴)
A/D converter resolution	16 bits (2400 LSB/div)
Temperature coefficient	When in waveform measurement mode (excluding AUTO filter) Zero point: ±(0.02 % of 10 div)/°C (typical value ⁴) Gain: ±0.02%/°C (typical value ⁴)
Bandwidth limit	Select from Full, Auto, 4 kHz, 400 Hz, 40 Hz Cutoff characteristics: -12 dB/OCT (typical value, ⁴ setting other than AUTO) Cutoff frequency (fc) when set to AUTO Sample rate at 100 kHz or higher: fc = 40 kHz Sample rate at 100 Hz to 50 kHz: fc = 40 % of the sampling rate Sample rate at 50 kHz or less: fc = 20 Hz Cutoff characteristics when set to AUTO: -65 dB at 2×fc (typical value ⁴)
Probe attenuation settings	Voltage probe 1:1, 10:1, 100:1, 1000:1 Current probe 1 A:1 V, 10 A:1 V, 100 A:1 V Clamp-on probe 1 A:10 mV, 1 A:2.5 mV
Compliant voltage probe	701940 (17 to 46 pF)
Sensor supply current (voltage)	OFF/4 mA ±10 % (approx. 22 VDC)
Applicable acceleration sensor	Built-in amplifier type Kistler Instrument Corporation: Piezotron, PCB Piezotronics Incorporated: ICP, ENDEVCO Corporation: ISOTRON, etc.

7.15 Module Specifications

Item	Specifications
Table of cutoff frequency characteristics of the anti-aliasing filter (AAF)	When the filter is set to Auto, the anti-aliasing filter and low-pass filter are automatically set according to the sample rate.

Sample rate	AAF	Low-Pass Filter
100 kS/s	40 kHz	OFF
50 kS/s	20 kHz	OFF
20 kS/s	8 kHz	OFF
10 kS/s	4 kHz	4 kHz
5 kS/s	2 kHz	4 kHz
2 kS/s	800 Hz	4 kHz
1 kS/s	400 Hz	400 Hz
500 S/s	200 Hz	400 Hz
200 S/s	80 Hz	400 Hz
100 S/s	40 Hz	40 Hz
50 S/s	20 Hz	40 Hz
20 S/s to 5 S/s	20 Hz	40 Hz
2 S/s or less	20 Hz	40 Hz
Ext sample	40 kHz	OFF

1 Value measured under standard operating conditions

With the 10:1 passive probe (701940)

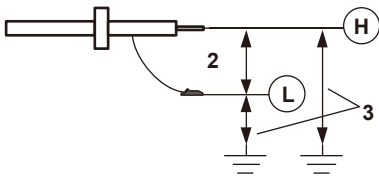

Direct input (cable that does not comply with the safety standards)

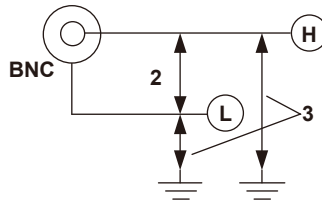

4 Typical values represent typical or average values. They are not strictly warranted.

Frequency Module (701281)

Item	Specifications
Standard operating conditions	Temperature: 23 ±5 °C Humidity: 20 to 80 % RH After a 30-minute warm-up
Measurement function	Frequency, RPMs, RPSs, period, duty cycle, power supply frequency, pulse width, pulse integration, and velocity
Effective measurement range	20 div (display range: 10 div)
Number of input channels	2
Data update rate	1 MHz (1 μs)
Output delay time	Approx. 3 μs
Input type	Isolated unbalanced
Input connector	BNC connector (isolated type)
Maximum input voltage	Combined with the 700929 (10:1), 702902 (10:1), or 701947 (100:1): ² 420 V (DC+ACpeak) Combined with the (701901 + +701954) (1:1) or direct input (cable that does not comply with the safety standards): ⁴ 42 V (DC+ACpeak)
Maximum rated voltage to ground	Working voltage of safety standard Combined with the 700929 (10:1), 702902 (10:1), or 701947 (100:1): ³ 300 Vrms (CAT II)
Between input and case	
Between inputs	Combined with the (701901 + 701954) (1:1) or direct input (cable that does not comply with the safety standards): ⁵ 42 V (DC+ACpeak) (CAT II, 30 Vrms)
Withstand voltage	2300 Vrms for 2 seconds (across each input terminal and earth) (60 Hz)
Insulation resistance	500 VDC, 10 MΩ or more (across each input terminal and earth)
Minimum measurement resolution	625 ps
Measured data resolution	16 bits (2400 LSB/div)
Measurement accuracy ¹	<ul style="list-style-type: none"> • When in frequency, RPM, RPS, or velocity measurement mode⁶ Measurement accuracy is specified according to the measurement range and input frequency [Definition of measurement accuracy] ±(0.05 % of 10 div + accuracy dependent on the input frequency) [Accuracy dependent on the input frequency] Input frequency less than 2 kHz: 0.05 % of the input frequency + 0.001 Hz Input frequency 2 kHz to 50 kHz: 0.05 % of the input frequency Input frequency 50 kHz to 100 kHz: 0.1 % of the input frequency Input frequency 100 kHz to 200 kHz: 0.2 % of the input frequency Input frequency 200 kHz or higher: 0.5 % of the input frequency • When in power supply frequency mode⁷ When the center frequency is 50/60 Hz: ±0.03 Hz (resolution: 0.01 Hz) When the center frequency is 400 Hz: ±0.3 Hz (resolution: 0.01 Hz) (Input set to AC100 V or AC200 V with sine wave input) • When in period measurement mode⁶ Measurement accuracy is specified according to the measurement range and input period [Definition of measurement accuracy] ±(0.05 % of 10 div + accuracy dependent on the input period) [Accuracy dependent on the input period] Input period 500 μs or greater: 0.05 % of the input period Input period 20 μs to 500 μs: 0.1 % of the input period + 0.1 μs Input period 10 μs to 20 μs: 0.2 % of the input period + 0.1 μs Input period less than 10 μs: 0.5 % of the input period + 0.1 μs • When in duty cycle measurement mode⁸ Dependent on the input frequency Input frequency less than 50 kHz: ±0.1 % Input frequency 50 kHz to 100 kHz: ±0.2 % Input frequency 100 kHz to 200 kHz: ±0.5 % Input frequency 200 kHz to 500 kHz: ±1.0 %

7.15 Module Specifications

Item	Specifications
	<ul style="list-style-type: none"> • When in pulse width measurement mode⁸ Measurement accuracy is specified according to the measurement range and input pulse width [Definition of measurement accuracy] $\pm(0.05\% \text{ of } 10 \text{ div} + \text{accuracy dependent on the input pulse width})$ [Accuracy dependent on the input pulse width] Input pulse width 500 μs or greater: 0.05 % of the input pulse width Input pulse width 20 μs to 500 μs: 0.1 % of the input pulse width + 0.1 μs Input pulse width 10 μs to 20 μs: 0.2 % of the input pulse width + 0.1 μs Input pulse width less than 10 μs: 0.5 % of the input pulse width + 0.1 μs
Input voltage range ($\pm\text{FS}$)	When using 1:1 probe factor: $\pm 1 \text{ V}, \pm 2 \text{ V}, \pm 5 \text{ V}, \pm 10 \text{ V}, \pm 20 \text{ V}, \pm 50 \text{ V} (\pm\text{FS})$
Input impedance	1 M Ω $\pm 1\%$, approx. 35 pF Pull-up function: 10 k Ω , approx. 5 V (pull-up can be turned ON only when the input is set to Pull-up 5 V)
Input coupling settings	AC, DC
Probe attenuation settings	10:1, 1:1
Minimum voltage width for pulse detection	200 mV _{P-P}
Bandwidth limit	Select from Full, 100 kHz, 10 kHz, 1 kHz, 100 Hz Cutoff characteristics: -12 dB/OCT (typical value ⁹)
Threshold level	Set within the FS of the voltage range. Set in units of 1 % of the FS.
Hysteresis	Select $\pm 1\%$, $\pm 2.5\%$, or $\pm 5\%$ of the FS of the voltage range
Preset function	Logic (5 V/3 V/12 V/24 V), electromagnetic pickup, zero crossing, pull-up, AC100 V, AC200 V, and user-defined
Slope selection	Rising or falling edge selectable
3 dB point when AC coupled	0.5 Hz or less (0.05 Hz or less when using the 700929 or 702902, 0.005 Hz or less when using the 701947) (typical value ⁹)
Chatter elimination function	OFF or 1 to 1000 ms (1 ms resolution) Eliminates the chatter that occurs such when the contact input is turned ON/OFF. Can discard the signal changes over the specified interval.
Input status indication function	Input status indication through the LEDs of each channel function When in operation: Illuminates in green when pulse input is detected When overdriven: Illuminates in red when the input voltage exceeds the range

1 Value measured under standard operating conditions

Combined with the 700929, 702902, or 701947

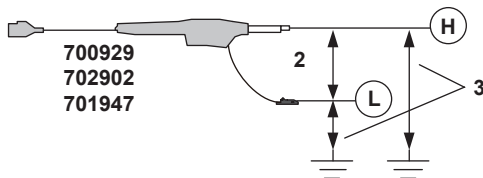

Combined with the (701901 + 701954) or direct input (cable that does not comply with the safety standards)

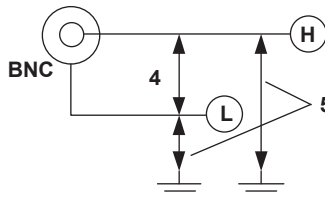

- Input waveform of 1 V_{pp}, rectangular wave, rise/fall time within 1 μs (input range: $\pm 10 \text{ V}$, bandwidth limit: Full, and hysteresis: $\pm 1\%$)
- Input waveform of 90 V_{rms}, sine wave (input range: AC100 V, bandwidth limit 100 kHz, and hysteresis: $\pm 1\%$)
- Input waveform of 1 V_{pp}, rectangular wave, rise/fall time within 5 ns (input range: $\pm 10 \text{ V}$, bandwidth limit: Full, and hysteresis: $\pm 1\%$)
- Typical values represent typical or average values. They are not strictly warranted.

Specifications by Measurement Modes

Item	Specifications
Frequency	
Measurable frequency range	0.01 Hz to 500 kHz
Selectable vertical scale	0.1 Hz/div to 100 kHz/div (1-2-5 steps)
Minimum resolution	0.001 Hz
RPMs	
Measurable revolution range	0.01 rpm to 100000 rpm (where the input frequency is DC to 500 kHz).
Selectable vertical scale	0.1 rpm/div to 10 krpm/div (1-2-5 steps)
Computing method	Computed from the frequency based on the number of pulses per rotation RPMs = Frequency/(pulse/rotate value) × 60
Selectable pulse/rotate range	1 to 99999
RPSs	
Measurable revolution range	0.001 rps to 2000 rps (where the input frequency is DC to 500 kHz).
Selectable vertical scale	0.01 rps/div to 200 rps/div (1-2-5 steps)
Computing method	Computed from the frequency based on the number of pulses per rotation RPSs = Frequency/(pulse/rotate value)
Selectable pulse/rotate range	1 to 99999
Period	
Measurable period range	2 μs to 50 s (except, the minimum pulse width is 1 μs)
Selectable vertical scale	10 μs/div to 5 s/div (1-2-5 steps)
Minimum resolution	0.1 μs
Duty	
Measurable duty cycle range	0 to 100 %
Selectable vertical scale	1 %/div to 20 %/div (1-2-5 steps)
Measurable frequency range	0.1 Hz to 500 kHz
Measurement pulse selection	Select positive or negative pulse
Minimum resolution	0.1 μs
Power supply frequency	
Measurable frequency range	30 Hz to 70 Hz (when the center frequency is 50 Hz), 40 Hz to 80 Hz (when the center frequency 60 Hz), 380 Hz to 420 Hz (when the center frequency 400 Hz)
Selectable vertical scale	0.1 Hz/div to 2 Hz/div (0.01 Hz resolution)
Center frequency setting	Select 50 Hz, 60 Hz, or 400 Hz
Minimum resolution	0.01 Hz
Pulse width	
Measurable pulse width	1 μs to 50 s (where the input frequency is DC to 500 kHz).
Selectable vertical scale	10 μs/div to 5 s/div (1-2-5 steps)
Measurement pulse selection	Select positive or negative pulse
Minimum resolution	0.1 μs
Pulse integration	
Maximum pulse count	2×10 ⁹ pulses
Selectable vertical scale	500.0E+18 value/div to 10.00E-21 value/div (1-2-5 range: total of 123 ranges)
Frequency measuring range	0.1 Hz to 500 kHz (except, the minimum pulse width is 1 μs)
Computation function	Set the physical amount per pulse and display by converting the values into physical values such as distance and flow rate.
Selectable Unit/Pulse range	-9.9999E+30 to +9.9999E+30
Counter reset	Manual reset and over-limit reset
Velocity	
Selectable vertical scale	500.0E+18 value/div to 10.00E-21 value/div (1-2-5 range: total of 123 ranges)
Computing method	Set the amount of displacement per pulse and compute the velocity from the frequency. Automatic unit time conversion of s, min, and hour.
Selectable Distance/Pulse range	-9.9999E+30 to +9.9999E+30

Functional Specifications

Item	Specifications
Deceleration prediction	Computes the deceleration condition in real-time when the pulse input is cut off. Can be specified when measuring the frequency, RPMs, RPSs, period, and velocity
Stop prediction	Sets the frequency to 0 after a certain time elapses after the pulse input is cut off. Stop interval setting: Set in the range of 1.5 to 10 times (10 settings) the period of the pulse measured last Can be specified when measuring the frequency, RPMs, RPSs, period, and velocity
Smoothing	Computes the moving average of the measured data using the specified time Specified time: 0.1 to 1000 ms (0.1 ms resolution) Can be specified on all measurement parameters
Pulse average	Performs frequency measurement per specified number of pulses. When fluctuation exists periodically in the pulse interval, the fluctuation can be eliminated. Specified number of pulses: 1 to 4096 Can be specified when measuring the frequency, RPMs, RPSs, power supply frequency, period, pulse integration, and velocity
Offset function	Observe fluctuation with respect to the offset frequency Offset range: Can be set up to 1000 times the maximum div value <ul style="list-style-type: none"> • Frequency: 0 Hz to 500 kHz • RPMs: 0 rpm to 50 krpm • RPSs: 0 rps to 1000 rps • Period: 0 s to 50 s • Duty cycle: 0 % to 100 % • Pulse width: 0 s to 50 s • Pulse integration: -1.0000×10^{22} to 1.0000×10^{22} • Velocity: -1.0000×10^{22} to 1.0000×10^{22}

Frequency Module (720281)

Item	Specifications
Standard operating conditions	Temperature: 23 ±5 °C Humidity: 20 to 80 % RH After a 30-minute warm-up
Measurement function	Frequency, RPMs, RPSs, period, duty cycle, power supply frequency, pulse width, pulse integration, and velocity
Effective measurement range	20 div (display range: 10 div)
Number of input channels	2
Data update rate	1 MHz (1 μs)
Output delay time	Approx. 3 μs
Input type	Isolated unbalanced
Input connector	BNC connector (isolated type)
Maximum input voltage	Combined with the 700929 (10:1), 702902 (10:1), or 701947 (100:1): ² 420 V (DC+ACpeak) Combined with the (701901 + +701954) (1:1) or direct input (cable that does not comply with the safety standards): ⁴ 42 V (DC+ACpeak)
Maximum rated voltage to ground	Working voltage of safety standard Combined with the 700929 (10:1), 702902 (10:1), or 701947 (100:1): ³ 400 Vrms (CAT II)
Between input and case	
Between inputs	Combined with the (701901 + 701954) (1:1) or direct input (cable that does not comply with the safety standards): ⁵ 42 V (DC+ACpeak) (CAT II, 30 Vrms)
Withstand voltage	2300 Vrms for 2 seconds (across each input terminal and earth) (60 Hz)
Insulation resistance	500 VDC, 10 MΩ or more (across each input terminal and earth)
Minimum measurement resolution	625 ps
Measured data resolution	16 bits (2400 LSB/div)
Measurement accuracy ¹	<ul style="list-style-type: none"> • When in frequency, RPM, RPS, or velocity measurement mode⁶ Measurement accuracy is specified according to the measurement range and input frequency [Definition of measurement accuracy] ±(0.05 % of 10 div + accuracy dependent on the input frequency) [Accuracy dependent on the input frequency] Input frequency less than 2 kHz: 0.05 % of the input frequency + 0.001 Hz Input frequency 2 kHz to 50 kHz: 0.05 % of the input frequency Input frequency 50 kHz to 100 kHz: 0.1 % of the input frequency Input frequency 100 kHz to 200 kHz: 0.2 % of the input frequency Input frequency 200 kHz or higher: 0.5 % of the input frequency • When in power supply frequency mode⁷ When the center frequency is 50/60 Hz: ±0.03 Hz (resolution: 0.01 Hz) When the center frequency is 400 Hz: ±0.3 Hz (resolution: 0.01 Hz) (Input set to AC100 V or AC200 V with sine wave input) • When in period measurement mode⁶ Measurement accuracy is specified according to the measurement range and input period [Definition of measurement accuracy] ±(0.05 % of 10 div + accuracy dependent on the input period) [Accuracy dependent on the input period] Input period 500 μs or greater: 0.05 % of the input period Input period 20 μs to 500 μs: 0.1 % of the input period + 0.1 μs Input period 10 μs to 20 μs: 0.2 % of the input period + 0.1 μs Input period less than 10 μs: 0.5 % of the input period + 0.1 μs • When in duty cycle measurement mode⁸ Dependent on the input frequency Input frequency less than 50 kHz: ±0.1 % Input frequency 50 kHz to 100 kHz: ±0.2 % Input frequency 100 kHz to 200 kHz: ±0.5 % Input frequency 200 kHz to 500 kHz: ±1.0 %

7.15 Module Specifications

Item	Specifications								
	<ul style="list-style-type: none"> • When in pulse width measurement mode⁸ <p>Measurement accuracy is specified according to the measurement range and input pulse width [Definition of measurement accuracy] ±(0.05 % of 10 div + accuracy dependent on the input pulse width) [Accuracy dependent on the input pulse width]</p> <table border="0"> <tr> <td>Input pulse width 500 μs or greater:</td> <td>0.05 % of the input pulse width</td> </tr> <tr> <td>Input pulse width 20 μs to 500 μs:</td> <td>0.1 % of the input pulse width + 0.1 μs</td> </tr> <tr> <td>Input pulse width 10 μs to 20 μs:</td> <td>0.2 % of the input pulse width + 0.1 μs</td> </tr> <tr> <td>Input pulse width less than 10 μs:</td> <td>0.5 % of the input pulse width + 0.1 μs</td> </tr> </table> 	Input pulse width 500 μs or greater:	0.05 % of the input pulse width	Input pulse width 20 μs to 500 μs:	0.1 % of the input pulse width + 0.1 μs	Input pulse width 10 μs to 20 μs:	0.2 % of the input pulse width + 0.1 μs	Input pulse width less than 10 μs:	0.5 % of the input pulse width + 0.1 μs
Input pulse width 500 μs or greater:	0.05 % of the input pulse width								
Input pulse width 20 μs to 500 μs:	0.1 % of the input pulse width + 0.1 μs								
Input pulse width 10 μs to 20 μs:	0.2 % of the input pulse width + 0.1 μs								
Input pulse width less than 10 μs:	0.5 % of the input pulse width + 0.1 μs								
Input voltage range (±FS)	When using 10:1 probe factor ±10 V, ±20 V, ±50 V, ±100 V, ±200 V, ±500 V (±FS) (Combined with the 700929)								
Input impedance	1 MΩ ±1 %, approx. 35 pF Pull-up function: 10 kΩ, approx. 5 V (pull-up can be turned ON only when the input is set to Pull-up 5 V)								
Input coupling settings	AC, DC								
Probe attenuation settings	10:1, 1:1								
Minimum voltage width for pulse detection	200 mV _{P-P}								
Bandwidth limit	Select from Full, 100 kHz, 10 kHz, 1 kHz, 100 Hz Cutoff characteristics: -12 dB/OCT (typical value ⁹)								
Threshold level	Set within the FS of the voltage range. Set in units of 1 % of the FS.								
Hysteresis	Select ±1 %, ±2.5 %, or ±5 % of the FS of the voltage range								
Preset function	Logic (5 V/3 V/12 V/24 V), electromagnetic pickup, zero crossing, pull-up, AC100 V, AC200 V, and user-defined								
Slope selection	Rising or falling edge selectable								
3 dB point when AC coupled	0.5 Hz or less (0.05 Hz or less when using the 700929 or 702902, 0.005 Hz or less when using the 701947) (typical value ⁹)								
Chatter elimination function	OFF or 1 to 1000 ms (1 ms resolution) Eliminates the chatter that occurs such when the contact input is turned ON/OFF. Can discard the signal changes over the specified interval.								
Input status indication function	Input status indication through the LEDs of each channel function When in operation: Illuminates in green when pulse input is detected When overdriven: Illuminates in red when the input voltage exceeds the range								

1 Value measured under standard operating conditions

Combined with the 700929, 702902, or 701947

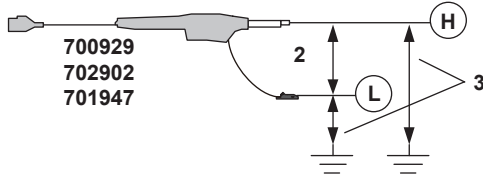

Combined with the (701901 + 701954) or direct input (cable that does not comply with the safety standards)

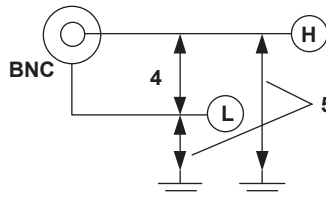

- 6 Input waveform of 1 V_{pp}, rectangular wave, rise/fall time within 1 μs (input range: ±10 V, bandwidth limit: Full, and hysteresis: ±1 %)
- 7 Input waveform of 90 V_{rms}, sine wave (input range: AC100 V, bandwidth limit 100 kHz, and hysteresis: ±1 %)
- 8 Input waveform of 1 V_{pp}, rectangular wave, rise/fall time within 5 ns (input range: ±10 V, bandwidth limit: Full, and hysteresis: ±1 %)
- 9 Typical values represent typical or average values. They are not strictly warranted.

Specifications by Measurement Modes

Item	Specifications
Frequency	
Measurable frequency range	0.01 Hz to 500 kHz
Selectable vertical scale	0.1 Hz/div to 100 kHz/div (1-2-5 steps)
Minimum resolution	0.001 Hz
RPMs	
Measurable revolution range	0.01 rpm to 100000 rpm (where the input frequency is DC to 500 kHz).
Selectable vertical scale	0.1 rpm/div to 10 krpm/div (1-2-5 steps)
Computing method	Computed from the frequency based on the number of pulses per rotation RPMs = Frequency/(pulse/rotate value) × 60
Selectable pulse/rotate range	1 to 99999
RPSs	
Measurable revolution range	0.001 rps to 2000 rps (where the input frequency is DC to 500 kHz).
Selectable vertical scale	0.01 rps/div to 200 rps/div (1-2-5 steps)
Computing method	Computed from the frequency based on the number of pulses per rotation RPSs = Frequency/(pulse/rotate value)
Selectable pulse/rotate range	1 to 99999
Period	
Measurable period range	2 μs to 50 s (except, the minimum pulse width is 1 μs)
Selectable vertical scale	10 μs/div to 5 s/div (1-2-5 steps)
Minimum resolution	0.1 μs
Duty	
Measurable duty cycle range	0 to 100 %
Selectable vertical scale	1 %/div to 20 %/div (1-2-5 steps)
Measurable frequency range	0.1 Hz to 500 kHz
Measurement pulse selection	Select positive or negative pulse
Minimum resolution	0.1 μs
Power supply frequency	
Measurable frequency range	30 Hz to 70 Hz (when the center frequency is 50 Hz), 40 Hz to 80 Hz (when the center frequency 60 Hz), 380 Hz to 420 Hz (when the center frequency 400 Hz)
Selectable vertical scale	0.1 Hz/div to 2 Hz/div (0.01 Hz resolution)
Center frequency setting	Select 50 Hz, 60 Hz, or 400 Hz
Minimum resolution	0.01 Hz
Pulse width	
Measurable pulse width	1 μs to 50 s (where the input frequency is DC to 500 kHz).
Selectable vertical scale	10 μs/div to 5 s/div (1-2-5 steps)
Measurement pulse selection	Select positive or negative pulse
Minimum resolution	0.1 μs
Pulse integration	
Maximum pulse count	2×10 ⁹ pulses
Selectable vertical scale	500.0E+18 value/div to 10.00E-21 value/div (1-2-5 range: total of 123 ranges)
Frequency measuring range	0.1 Hz to 500 kHz (except, the minimum pulse width is 1 μs)
Computation function	Set the physical amount per pulse and display by converting the values into physical values such as distance and flow rate.
Selectable Unit/Pulse range	-9.9999E+30 to +9.9999E+30
Counter reset	Manual reset and over-limit reset
Velocity	
Selectable vertical scale	500.0E+18 value/div to 10.00E-21 value/div (1-2-5 range: total of 123 ranges)
Computing method	Set the amount of displacement per pulse and compute the velocity from the frequency. Automatic unit time conversion of s, min, and hour.
Selectable Distance/Pulse range	-9.9999E+30 to +9.9999E+30

Functional Specifications

Item	Specifications
Deceleration prediction	Computes the deceleration condition in real-time when the pulse input is cut off. Can be specified when measuring the frequency, RPMs, RPSs, period, and velocity
Stop prediction	Sets the frequency to 0 after a certain time elapses after the pulse input is cut off. Stop interval setting: Set in the range of 1.5 to 10 times (10 settings) the period of the pulse measured last Can be specified when measuring the frequency, RPMs, RPSs, period, and velocity
Smoothing	Computes the moving average of the measured data using the specified time Specified time: 0.1 to 1000 ms (0.1 ms resolution) Can be specified on all measurement parameters
Pulse average	Performs frequency measurement per specified number of pulses. When fluctuation exists periodically in the pulse interval, the fluctuation can be eliminated. Specified number of pulses: 1 to 4096 Can be specified when measuring the frequency, RPMs, RPSs, power supply frequency, period, pulse integration, and velocity
Offset function	Observe fluctuation with respect to the offset frequency Offset range: Can be set up to 1000 times the maximum div value <ul style="list-style-type: none"> • Frequency: 0 Hz to 500 kHz • RPMs: 0 rpm to 50 krpm • RPSs: 0 rps to 1000 rps • Period: 0 s to 50 s • Duty cycle: 0 % to 100 % • Pulse width: 0 s to 50 s • Pulse integration: -1.0000×10^{22} to 1.0000×10^{22} • Velocity: -1.0000×10^{22} to 1.0000×10^{22}

High-Speed 200MS/s, 14bit Isolation Module (720212)

Item	Specifications
Standard operating conditions	Temperature: 23 ±5 °C Humidity: 20 to 80 % RH After a 30 minute warm-up and after calibration
Effective measurement range	20 div (display range: 10 div)
Number of input channels	2
Input coupling settings	AC, DC, GND
Maximum sample rate	200 MS/s
Input type	Isolated unbalanced
Frequency characteristics ¹ (-3 dB point a when sine wave of amplitude ±3 div is applied)	DC to 40 MHz
Voltage scale setting	10 mV/div to 20 V/div (1-2-5 steps) (when using 1:1 probe factor)
Maximum input voltage (at a frequency of 1 kHz or less)	Combined with the 700929 (10:1), 702902 (10:1), or 701947 (100:1): ² 1000 V (DC+ACpeak) CAT II Combined with the 701901 + 701954 (1:1): ⁴ 200 V (DC+ACpeak) CAT II Direct input (cable that does not comply with the safety standards): ⁶ 42 V (DC+ACpeak)
Maximum rated voltage to ground Between input and ground and between inputs (at a frequency of 1 kHz or less)	Safety standard's working voltage Combined with 700929 (10:1), 702902 (10:1), 701947 (100:1) ³ or combined with 701901 + 701954 (1:1): ⁵ 1000 Vrms CAT II Direct input (cable that does not comply with the safety standards): ⁷ 42 V (DC+ACpeak)
Vertical (voltage) axis accuracy DC accuracy ¹	±(0.5 % of 10 div)
Input connector	BNC connector (isolated type)
Input impedance	1 MΩ ±1 %, approx. 35 pF
3 dB point when AC coupled	10 Hz or less
Common mode rejection ratio	80 dB or more (50/60 Hz) (typical value ⁸)
Residual noise level (input section shorted)	±0.15 div (typical value ⁸)
Withstand voltage	5400 Vrms for 2 seconds (across each input terminal and earth), 60 Hz
Allowable transient surge voltage	±2100 Vpeak (across each input terminal and earth)
Insulation resistance	500 VDC, 10 MΩ or more (across each input terminal and earth)
A/D converter resolution	14 bits (600 LSB/div)
Temperature coefficient	Zero point: ±(0.1 % of 10 div)/°C (typical value ⁸) Gain: ±0.05%/°C (typical value ⁸)
Bandwidth limit	Select Full (no bandwidth limit) or from the following filters. Analog filter Cutoff frequency: 5 MHz (typical value ⁸) Cutoff characteristics: -12 dB/OCT (typical value ⁸) Digital filter Cutoff frequency: 2.56 MHz, 1.28 MHz, 640 kHz, 320 kHz, 160 kHz, 80 kHz, 40 kHz, 20 kHz, 10 kHz Filter type: IIR
Probe attenuation settings	Voltage probe: 1:1, 10:1, 100:1, 1000:1 Current probe: 1 A:1 V, 10 A:1 V, 100 A:1 V, 1 A:10 mV, 1 A:2.5 mV

7.15 Module Specifications

- 1 Value measured under standard operating conditions

Combined with the 700929, 702902, or 701947

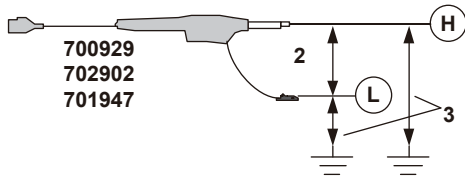

With the 701901 and 701954

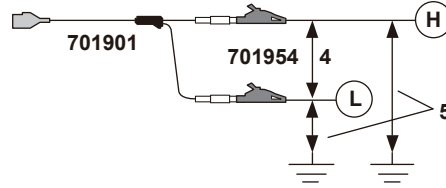

Direct input (cable that does not comply with the safety standards)

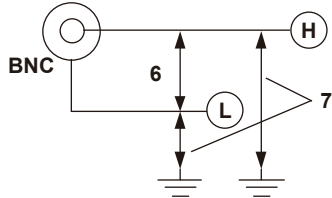

- 8 Typical values represent typical or average values. They are not strictly warranted.

High-Speed 100 MS/s, 12-Bit Isolation Module (720211)

Item	Specifications
Standard operating conditions	Temperature: 23 ±5 °C Humidity: 20 to 80 % RH After a 30 minute warm-up and after calibration
Effective measurement range	20 div (display range: 10 div)
Number of input channels	2
Input coupling settings	AC, DC, GND
Maximum sample rate	100 MS/s
Input type	Isolated unbalanced
Frequency characteristics ¹ (-3 dB point a when sine wave of amplitude ±3 div is applied)	DC to 20 MHz
Voltage scale setting	10 mV/div to 20 V/div (1-2-5 steps) (when using 1:1 probe factor)
Maximum input voltage (at a frequency of 1 kHz or less)	Combined with the 700929 (10:1), 702902 (10:1), or 701947 (100:1): ² 1000 V (DC+ACpeak) Combined with the 701901 + 701954 (1:1): ⁴ 200 V (DC+ACpeak) Direct input (cable that does not comply with the safety standards): ⁶ 42 V (DC+ACpeak)
Maximum rated voltage to ground Between input and case Between inputs (at a frequency of 1 kHz or less)	Working voltage of safety standard Combined with 700929 (10:1), 701947 (100:1) ³ or combined with 701901 + 701954 (1:1): ⁵ 1000 Vrms (CAT II) Combined with the 702902 (10:1): ³ 1000 V (DC+ACpeak) CAT II Direct input (cable that does not comply with the safety standards): ⁷ 42 V (DC+ACpeak) (CAT II, 30 Vrms)
Vertical (voltage) axis accuracy DC accuracy ¹	±(0.5 % of 10 div)
Input connector	BNC connector (isolated type)
Input impedance	1 MΩ ±1 %, approx. 35 pF
3 dB point when AC coupled	10 Hz or less (1 Hz or less when using the 700929 or 702902, 0.1 Hz or less when using the 701947)
Common mode rejection ratio	80 dB (50/60 Hz) or more (typical value ⁸)
Residual noise level (input section shorted)	±1.1 mV or ±0.15 div whichever is greater (typical value ⁸)
Withstand voltage	5400 Vrms for 2 seconds (across each input terminal and earth) (60 Hz)
Insulation resistance	500 VDC, 10 MΩ or more (across each input terminal and earth)
A/D converter resolution	12 bits (150 LSB/div)
Temperature coefficient	Zero point: ±(0.1 % of 10 div)/°C (typical value ⁸) Gain: ±0.05%/°C (typical value ⁸)
Bandwidth limit	Select from Full and 2 MHz Cutoff characteristics: -12 dB/OCT (typical value ⁸) Digital filter Cutoff frequency: 1.28 MHz, 640 kHz, 320 kHz, 160 kHz, 80 kHz, 40 kHz, 20 kHz, 10 kHz Filter type: IIR
Probe attenuation settings	Voltage probe: 1:1, 10:1, 100:1, 1000:1 Current probe: 1 A:1 V, 10 A:1 V, 100 A:1 V

7.15 Module Specifications

- 1 Value measured under standard operating conditions

Combined with the 700929, 702902, or 701947

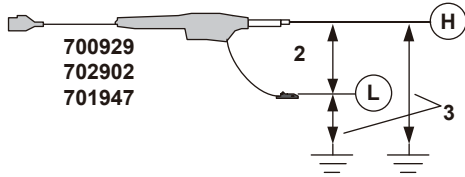

Combined with the 701901 and 701954

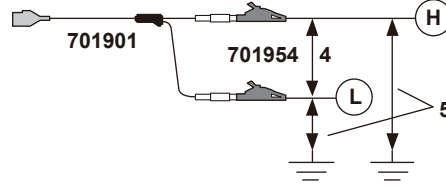

Direct input (cable that does not comply with the safety standards)

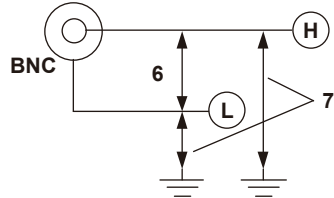

- 8 Typical values represent typical or average values. They are not strictly warranted.

16-CH Temperature/Voltage Input Module (720221)

Item	Specifications		
Standard operating conditions	Temperature:	23 ±5 °C	
	Humidity:	20 to 80 % RH	
After a 30 minute warm-up and after calibration			
Function	Temperature (thermocouple) or voltage measurement (DC coupling)		
Effective measurement range	[Voltage measurement] 20 div (display range: 10 div)		
Number of input sub channels	16		
Input coupling settings	TC, DC, OFF, GND		
	TC:	Temperature (thermocouple) measurement	
	DC:	Voltage measurement (DC coupling)	
Can be set separately for each sub channel			
Data update interval	100 ms, 300 ms, 1 s, 3 s		
Input type	Isolated unbalanced		
Measurement range/accuracy ¹	[Voltage measurement]	Voltage scale: 1 mV/div to 2 V/div (1-2-5 steps) Voltage accuracy: ±(0.15 % of 10 div)	
	[Temperature measurement] ²		
For the thermocouple standards, see the 701261 specifications.	Type	Measurement Range	Accuracy
	K	-200 to 1300 °C	±(0.1 % of reading + 1.5 °C) Except ±(0.2 % of reading + 1.5 °C) for -200 °C to 0 °C
	E	-200 to 800 °C	
	J	-200 to 1100 °C	
	T	-200 to 400 °C	
	L	-200 to 900 °C	
	U	-200 to 400 °C	
	N	0 to 1300 °C	
	R	0 to 1700 °C	±(0.1 % of reading + 3 °C)
	S	0 to 1700 °C	Except, 0 to 200 °C: ±8 °C 200 to 800 °C: ±5 °C
	B	0 to 1800 °C	±(0.1 % of reading + 2 °C) Except, 400 to 700 °C: ±8 °C Effective range is 400 to 1800 °C
	W	0 to 2300 °C	±(0.1 % of reading + 3 °C)
	Au7Fe ³	0 to 300 K	0 to 50 K: ±4 K 50 to 300 K: ±2.5 K
	Maximum input voltage ⁴ (at a frequency of 1 kHz or less)	Both temperature and voltage input:	42 V (DC+ACpeak)
Maximum rated voltage to ground ⁵ Between input and case Between inputs (at a frequency of 1 kHz or less)	Both temperature and voltage input:	42 V (DC+ACpeak) (CAT II, 30 Vrms)	
Vertical resolution	[Voltage measurement] During voltage input: [Temperature measurement] When measuring temperature:	2400 LSB/div 0.1 °C	
Common mode rejection ratio	[Voltage measurement]	100 dB or more (50/60 Hz) (typical value ⁶)	
	[Temperature measurement]	140 dB or more (50/60 Hz, at 3 s data update interval) (typical value ⁶)	
Residual noise level (input section shorted)	±0.01 div (typical value ⁶)		
A/D converter resolution	[Voltage measurement]	16 bits (2400 LSB/div)	
Temperature coefficient	Zero point:	±(0.025 % of 10 div)/°C (typical value ⁶)	
	Gain:	±0.01%/°C (typical value ⁶)	
Reference junction compensation accuracy (when the input terminal temperature is balanced)	K, E, J, T, L, U, N:	±1 °C	
	R, S, B, W:	±1.5 °C	
	Au7Fe:	±1 K	

7.15 Module Specifications

Item	Specifications
Bandwidth limit (typical value ⁶) (-3 dB point)	Data update interval
	100 ms: 600 Hz
	300 ms: 200 Hz
	1 s: 50 Hz
3 s: 10 Hz	
Input connector	Screw type
Input impedance	Approx. 1 MΩ
Interference between sub channels	100 dB or more (50/60 Hz) (typical value ⁶)
External scanner box	Model number: 701953, built-in reference junction Length of included cable: 1 m, 3 m (selectable)

- 1 Value measured under standard operating conditions
- 2 Does not include the reference junction temperature compensation accuracy.
- 3 This module supports Au7Fe with 0.07 % metal content with respect to gold.

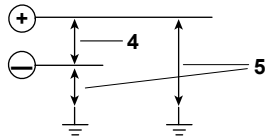

- 6 Typical values represent typical or average values. They are not strictly warranted.

Logic Input Module (720230)

Item	Specifications
Standard operating conditions	Ambient temperature: 23 to 5 °C Ambient humidity: 20 to 80 % RH
Number of input ports	2
Number of input bits	8 bit/Port
Maximum sample rate	10 MS/s
Input type	Use a non-isolated, dedicated probe (automatic detection)
Compatible probes	700986 (non-isolated 8-bit input) 700987 (isolated 8-bit input) 702911 (non-isolated 8-bit input) 702912 (non-isolated 8-bit input)
Chatter suppression time setting	Off, 5 ms, 10 ms, 20 ms, 50 ms, 100 ms

CAN Bus Monitor Module (720240)

Item	Specifications
Standard operating conditions	Ambient temperature: 23 to 5 °C Ambient humidity: 20 to 80 % RH
Number of input ports	2
Maximum sample rate	100 kS/s
Input type	Isolated unbalanced
Maximum input voltage	-3 V to +10 V (between CAN_H and GND or CAN_L and GND)
Maximum rated voltage to ground	42 V (DC+ACpeak) (CAT II, 30 Vrms)
Between input and case	
Between inputs	
Input connector	D-sub 9 pin (male)
Terminator	Internal. Can be enabled or disabled for each port
Supported protocols	Physical layer: ISO-11898 (High Speed Communication)
Supported bit rates ¹	10 kbps, 20 kbps, 33.3 kbps, 50 kbps, 62.5 kbps, 66.7 kbps, 83.3 kbps, 100 kbps, 125 kbps, 200 kbps, 250 kbps, 400 kbps, 500 kbps, 800 kbps, 1 Mbps
LED display	Illuminates to indicate that the terminator is enabled
Number of sub channels	60 sub channels/ports
One shot output	Frames can be output in single shots.
Terminator resistance (when the terminator is enabled)	110 to 130 Ω
A/D converter resolution	(when Value Type is set to Float) 16 bits (2400 LSB/div)

1 Low-speed CAN at low-speed transceiver levels is not supported.

CAN & LIN Bus Monitor Module (720241)

Item	Specifications
Standard operating conditions	Ambient temperature: 23 to 5 °C Ambient humidity: 20 to 80 % RH
Number of input ports	CAN port: 1. LIN port: 1.
Maximum sample rate	100 kS/s
Input type	Isolated unbalanced

CAN port

Item	Specifications
Maximum input voltage	-3 V to +10 V (between CAN_H and GND or CAN_L and GND)
Maximum rated voltage to ground	42 V (DC+ACpeak) (CAT II, 30 Vrms)
Between input and case	
Between inputs	
Input connector	D-sub 9 pin (male)
Terminator	Internal. Can be enabled or disabled for each port
Terminator resistance (when the terminator is enabled)	110 to 130 Ω
LED display	Illuminates to indicate that the terminator is enabled
Supported protocols	Physical layer: ISO-11898 (High Speed Communication)
Supported bit rates ¹	10 kbps, 20 kbps, 33.3 kbps, 50 kbps, 62.5 kbps, 66.7 kbps, 83.3 kbps, 100 kbps, 125 kbps, 200 kbps, 250 kbps, 400 kbps, 500 kbps, 800 kbps, 1 Mbps
Number of sub channels	60 sub channels
One shot output	Frames can be output in single shots.
A/D converter resolution	(when Value Type is set to Float) 16 bits (2400 LSB/div)

1 Low-speed CAN at low-speed transceiver levels is not supported.

LIN port

Item	Specifications
Maximum input voltage	-0.3 V to +18 V (between LIN.VBAT and GND)
Maximum rated voltage to ground	30 Vrms (CAT II)
Between input and case	
Between inputs	
Input connector	D-sub 9 pin (male)
Supported protocols	Physical layer: Complies with ISO9141
Supported bit rates	2400 bps, 9600 bps, 19200 bps
Number of sub channels	60 sub channels
Supported check sums	Standard check sum, extended check sum

CAN/CAN FD Monitor Module (720242)

Item	Specifications
Standard operating conditions	Ambient temperature: 23 to 5 °C Ambient humidity: 20 to 80 % RH
Number of input ports	2
Maximum sample rate	100 kS/s
Input type	ISO 11898 compliant differential input Inputs are isolated from the main unit. Ports are isolated from each other.
Maximum input voltage	-3 V to +10 V (between CAN_H and GND or CAN_L and GND)
Maximum rated voltage to ground	42 V (DC+ACpeak) (CAT II, 30 Vrms)
Between input and case	
Between inputs	
Input connector	D-sub 9 pin (male)
Terminator	Internal. Can be enabled or disabled for each port
Supported protocols	CAN, CAN FD (ISO 11898-1: 2015 or non-ISO), Physical layer: ISO-11898 (High Speed Communication)
Supported bit rates ¹	10 kbps, 20 kbps, 33.3 kbps, 50 kbps, 62.5 kbps, 66.7 kbps, 83.3 kbps, 100 kbps, 125 kbps, 200 kbps, 250 kbps, 400 kbps, 500 kbps, 800 kbps, 1 Mbps Flexible data rate: 1 Mbps, 2 Mbps, 3 Mbps, 4 Mbps, 5 Mbps
Sample point	65 % to 90 %, set in units of 1 %
LED display	Illuminates to indicate that the terminator is enabled
Number of sub channels	60 sub channels/ports
One shot output	Frames can be output in single shots. CAN/CAN FD package can be exported (packet format can be specified). Up to 64 bytes can be exported for CAN FD.
Terminator resistance (when the terminator is enabled)	110 to 130 Ω
A/D converter resolution	(when Value Type is set to Float) 16 bits (2400 LSB/div)

¹ Low-speed CAN at low-speed transceiver levels is not supported.

SENT Monitor Module (720243)

Item	Specifications
Standard operating conditions	Ambient temperature: 23 to 5 °C Ambient humidity: 20 to 80 % RH
Number of input ports	2
Maximum data update rate	100 kS/s (10 µs)
Input type	Isolated unbalanced
Input connector	BNC connector (isolated type)
Input impedance	1 MΩ ±1 %, approx. 35 pF
Supported protocols	SAE J2716
Supported clock tick span	1 µs to 100 µs, resolution: 0.01 µs
Supported number of nibbles	1 to 8
Number of analysis sub channels	8 channels total including fast channels and slow channels Fast Channel Up to 8 Slow Channel Up to 5 Status & Communication 1 ch (4 bit) Error trigger 1 ch (5 bit) Error count 1 ch
Fast channel analysis function	Handles fast channel multiplexing
Low level input voltage	1.5 V (typical value ¹)
High level input voltage	3.5 V (typical value ¹)
Maximum input voltage	Combined with the 700929 (10:1) or 702902 (10:1): ² 420 V (DC+ACpeak) Combined with the (701901 + +701954) (1:1) or direct input (cable that does not comply with the safety standards): ⁴ 42 V (DC+ACpeak)
Maximum rated voltage to ground	Working voltage of safety standard
Between input and case	42 V (DC+ACpeak) (CAT II, 30 Vrms)
Between inputs	
Input status indication function	Input status indication through the LEDs of each port function When in operation: Illuminates in green when pulse input is detected When overdriven: Illuminates in red when the input voltage exceeds 20 V
Probe attenuation settings	10:1, 1:1

1 Typical values represent typical or average values. They are not strictly warranted.

Combined with the 700929 or 702902

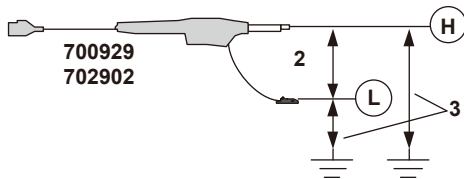

Combined with the (701901 + 701954) or direct input (cable that does not comply with the safety standards)

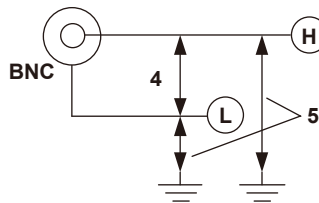

4-CH 1 MS/s, 16-Bit Isolation Module (720254)

Item	Specifications
Standard operating conditions	Temperature: 23 ±5 °C Humidity: 20 to 80 % RH After a 30 minute warm-up and after calibration
Effective measurement range	20 div (display range: 10 div)
Number of input channels	4
Input coupling settings	AC, DC, GND
Maximum sample rate	1 MS/s
Input type	Isolated unbalanced
Frequency characteristics ¹ (-3 dB point when a sine wave of amplitude ±3 div is applied)	DC to 300 kHz
Voltage scale setting	10 mV/div to 50 V/div (1-2-5 steps) (when using 1:1 probe factor)
Maximum input voltage (at a frequency of 1 kHz or less)	Combined with the 700929 (10:1), 702902 (10:1), or 701947 (100:1): ² 600 V (DC+ACpeak) Combined with the 701901 + 701954 (1:1): ⁴ 200 V (DC+ACpeak) (as a value that meets the safety standard) 400 V (DC+ACpeak) (maximum allowable voltage, as a value that does not damage the instrument when applied) Direct input (cable that does not comply with 42 V (DC+ACpeak) the safety standards): ⁶
Maximum rated voltage to ground	Working voltage of safety standard
Between input and case	Combined with 700929 (10:1), 702902 (10:1), 701947 (100:1) ³ or combined with 701901 + 701954 (1:1): ⁵
Between inputs (at a frequency of 1 kHz or less)	300 Vrms CAT II, 400 Vrms (measurement category Other (O) 1500 V transient overvoltage) Direct input (cable that does not comply with the safety standards): ⁷ 42 V (DC+ACpeak) (CAT II, 30 Vrms)
Vertical (voltage) axis accuracy DC accuracy ¹	±(0.25 % of 10 div)
Input connector	BNC connector (isolated type)
Input impedance	1 MΩ ±1 %, approx. 35 pF
3 dB point when AC coupled	1 Hz or less (0.1 Hz or less when using the 700929 or 702902, 0.01 Hz or less when using the 701947)
Common mode rejection ratio	80 dB (50/60 Hz) or more (typical value ⁸)
Residual noise level (input section shorted)	±0.05 div (typical value ⁸) 10 mV/div, 20 mV/div ±0.025 div (typical value ⁸) 50 mV/div to 20 V/div
Withstand voltage	2300 Vrms for 2 seconds (across each input terminal and earth) (60 Hz)
Insulation resistance	500 VDC, 10 MΩ or more (across each input terminal and earth)
A/D converter resolution	16 bits (2400 LSB/div)
Temperature coefficient	Zero point: ±(0.02 % of 10 div)/°C (typical value ⁸) Gain: ±0.02%/°C (typical value ⁸)
Bandwidth limit	Select from Full and 40 kHz Cutoff -12 dB/OCT (typical value ⁸) characteristics: Digital filter Cutoff frequency: 12.8 kHz, 6.4 kHz, 3.2 kHz, 1.6 kHz, 800 Hz, 400 Hz, 200 Hz, 100 Hz, 50 Hz, 25 Hz, 12.5 Hz, 6.25 Hz Filter type: IIR
Probe attenuation settings	Voltage probe: 1:1, 10:1, 100:1, 1000:1 Current probe: 1 A:1 V, 10 A:1 V, 100 A:1 V

7.15 Module Specifications

- 1 Value measured under standard operating conditions

Combined with the 700929, 702902, or 701947

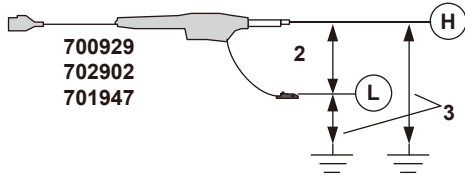

Combined with the 701901 and 701954

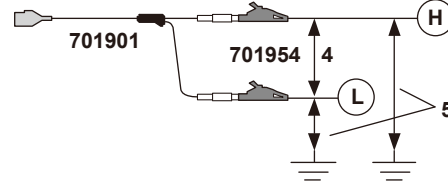

Direct input (cable that does not comply with the safety standards)

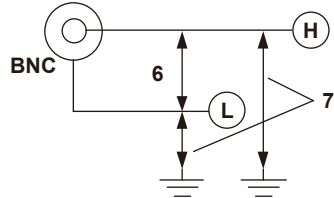

- 8 Typical values represent typical or average values. They are not strictly warranted.

7.16 Logic Probe Specifications

High-Speed Logic Probe (700986)

Item	Specifications
Number of inputs	8
Input type	Non-isolated (all the bits share the same ground with the DL950 and each other)
Maximum input voltage (at a frequency of 1 kHz or less)	42 V (DC+ACpeak) (CAT II, 30 Vrms), between the probe tip and ground
Response time	1 μ s (typical value ¹)
Input impedance	100 k Ω or more
Threshold level	Approx. 1.4 V

1 Typical values represent typical or average values. They are not strictly warranted.

Isolated Logic Probe (700987)

Item	Specifications
Number of inputs	8
Input type	Isolated (all bits are isolated)
Input connector	Safety terminal type (for banana plug) \times 8
Input switching	Each bit can be switched to AC or DC input.
Input signal display	The H/L state of each bit is indicated with LEDs (the LEDs illuminate to indicate H).
Applicable input range	During DC input: H/L detection of 10 VDC to 250 VDC H/L During AC input: H/L detection of 80 VAC to 250 VAC at 50/60 Hz
Threshold level	During DC input: 6 V \pm 50 % (High level: 10 to 250 VDC, Low level: 0 to 3 VDC) During AC input: 50 VAC \pm 50 % (High level: 80 to 250 VAC, Low level: 0 to 20 VAC)
Response time	During DC input: 1 ms (typical value ¹) During AC input: 20 ms (typical value ¹)
Input impedance	Approx. 100 k Ω
Maximum input voltage	250 Vrms ² (CAT II) (between the H and L terminals of each bit)
Maximum rated voltage to ground	250 Vrms ² (CAT II) (between input terminal H or L and the ground)
Between input and case	
Between inputs	
Maximum allowable voltage between bits	250 Vrms ² (CAT II)
Withstand voltage	2000 VAC for 1 minute (between the input terminals and the ground)
Insulation resistance	500 VDC, 10 M Ω or more (between the input terminals and the ground)
Fuse ³	Location: H side of input terminal Max. rated voltage: 250 V Max. rated current: 50 mA Type: Time lag Standard: VDE/SEMKO approved

- 1 Typical values represent typical or average values. They are not strictly warranted.
- 2 Make sure that the peak AC voltage does not exceed 350 V and that the DC voltage does not exceed 250 V when the frequency is 1 kHz or less.
- 3 Because the fuses used by this instrument are all inside the case, you cannot replace them yourself. If you believe that a fuse inside the case has blown, please contact your nearest YOKOGAWA dealer.

Logic Probe (702911 and 702912)

Item	Specifications
Number of inputs	8
Input type	Non-isolated (all the bits share the same ground with the DL950 and each other)
Maximum input voltage	± 35 V
Response time	3 μ s (typical value ¹)
Input impedance	10 k Ω or more
Threshold level	Approx. 1.4 V
Input methods	TTL level or contact input (switchable). During contact input: Pulled up to 5 V

1 Typical values represent typical or average values. They are not strictly warranted.

Note

Before using logic probes (702911, 702912) or isolated logic probe 700987, flip the switch back and forth several times. The switch's electrical contacts can weaken if not used for long periods of time.

7.17 16-CH Scanner Box Specifications

For the specifications other than the dimensions of the 16-CH Scanner Box, see the 16-CH Temperature/Voltage Input Module (720221) specifications.

External Dimensions

Unit: mm

Unless otherwise specified, tolerances are $\pm 3\%$ (however, tolerances are ± 0.3 mm when below 10 mm).

Instrument

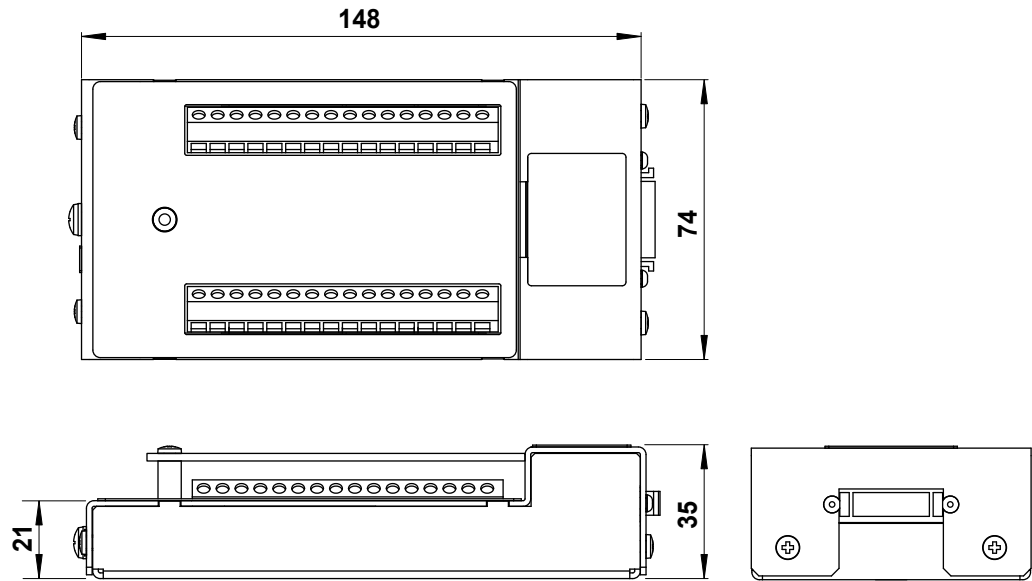

Attaching plate

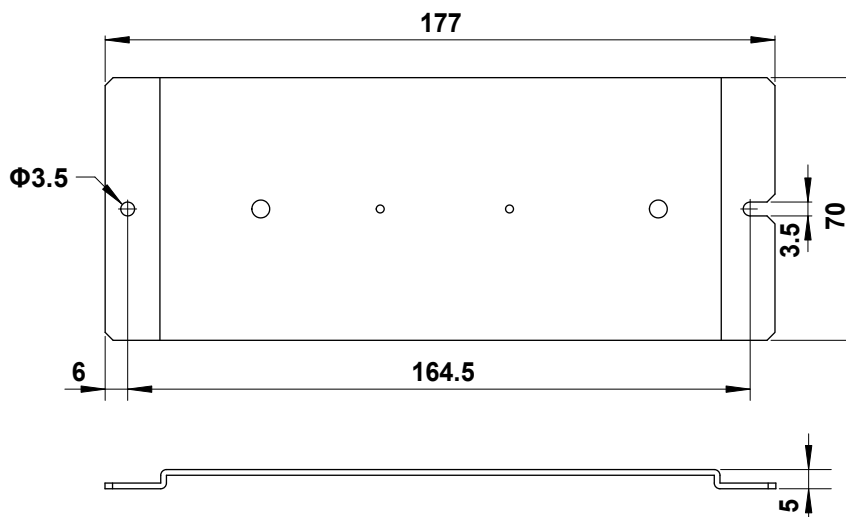

7.18 External Dimensions

Instrument

Unit: mm

Unless otherwise specified, tolerances are $\pm 3\%$ (however, tolerances are ± 0.3 mm when below 10 mm).

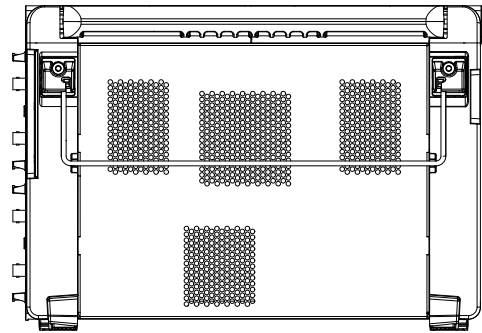
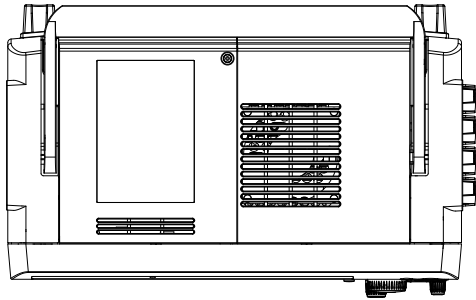

Rear view

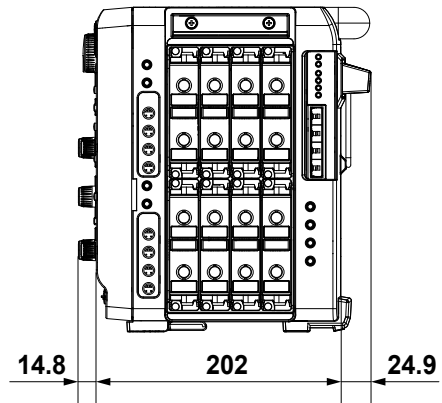
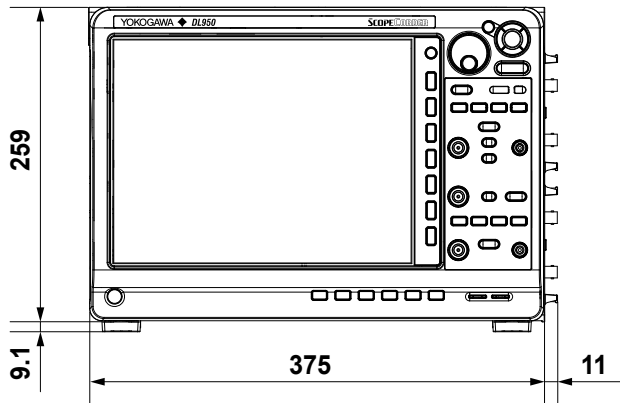

Appendix 1 Using the Appendix

Appendices 2 to 8 of this manual provide reference materials for that you can use when considering the measurement conditions for acquiring waveforms. This section explains how to use the appendix when setting the time scale on this instrument and other related items.

Examples of Using the Appendix (When using dual capture)

DL950 (standard model)

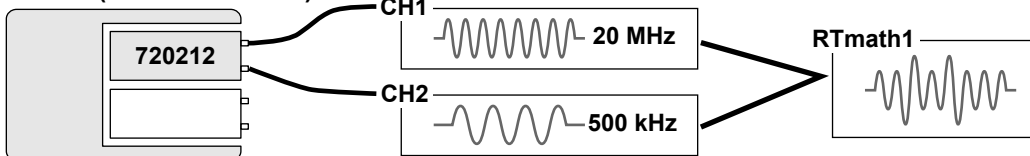

Consider the measuring conditions

- Measure at a sample rate of 200 MS/s according to the frequency of the CH1 waveform (10 times 20 MHz as an example).
- Measure in Scope mode as we would like to observe the long-term trend using dual capture.
- We want to use the real time math function so we will use one of the RTmath channels.

Appendix 4: Check the maximum record length that can be specified

- RTmath uses two input channels, so using CH1, CH2, and RTmath1 will use four channels in the same memory join group. For details on the memory join group, see “Memory Join Group” on page App-5.
- On the standard model (1 Gpoints), when dual capture is turned on, the maximum record length obtained from the number of channels used (8 (or 4)) is 50 Mpoints in low-speed sampling and 25 Mpoints in high-speed sampling.

Appendix 7: Check the acquisition count of the high-speed sampling waveform

- If we set the record length in dual capture’s high-speed sampling to the maximum of 25 Mpoints, we can see that the number of waveform acquisitions is one.
- To increase the number of acquisitions, we make the record length shorter. For example, we can see that if we set the record length to 50 kpoints, we can acquire waveforms 511 times. If we set the record length to 25 kpoints, we can acquire 1023 times.

Appendix 2: Consider the record length and measurement time

Consider high-speed sampling

- Because we will use the high-speed 200 MS/s module, we refer to tables M-1 to M-4 in appendix 2.
- If we set the record length to the maximum of 25 Mpoints, we can measure at a sample rate of 200 MS/s and a measurement time of 100 ms (Time/div is 10 ms) (see M-3), but to make the number of waveform acquisition to the maximum of 511, we set the record length to 50 kpoints and measure at the measurement time of 200 μ s (Time/div is 20) (see M-1).
- Because the sample rate in high-speed sampling of CH2 does not need to be as fast as CH1, to reduce the number of data points, we change the CH2 sample rate [SampleRate] from 200 MS/s to 5 MS/s in the channel settings.

Consider low-speed sampling

- Because the sample rate in low-speed sampling is maximum at 100kS/s regardless of the module, we refer to tables M-18 to M-20 and M-22 to M-24 in appendix 2.
- Because we want to measure as long as possible at the maximum sample rate of 100 kS/s, we set the record length to the maximum of 50 Mpoints and the measurement time to 300 s (Time/div is 30s) (see M-19).

For details on using the appendix, see the following pages.

By using the application menu (see section 2.2), you can configure the instrument by following the guide on the screen.

When Measuring in Scope Mode (Appendix 4)

- In Scope mode, the memory size per channel is divided into compartments by the record length (the number data points assigned to a waveform), and waveforms are acquired in areas that are record length in size.
- The memory size per channel (the maximum record length) is determined by the total acquisition memory size and the number of channels used. For the maximum record length, see appendix 4. For a description of how to count the number of channels, see page App-5.

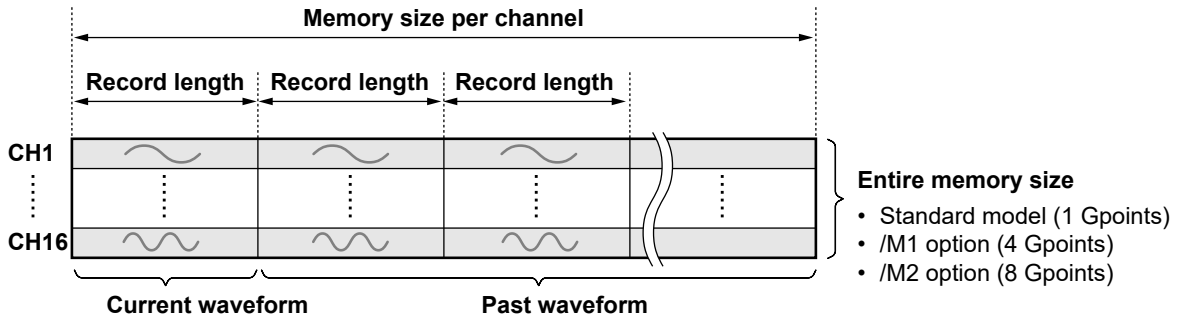

Measurement Time and Sample Rate (Appendix 2)

- The sample rate is determined indirectly by the time scale (TIME/DIV) and record length. For the relationship between the sampler, time scale, and record length, see appendix 2. For the maximum sample rate, see page App-5.

Example of Measurement Time and Sample Rate (200 MS/s module)

Measurement time (Time scale ×10)	Record Length and Sample Rate			
	Standard Model ¹	/M1 model ¹	/M2 model ¹	SSD Recording ²
	500 Mpoint	2 Gpoint	4 Gpoint	50 Gpoint
20 s	20 MS/s	100 MS/s	200 MS/s	2 MS/s
300 s	1 MS/s	5 MS/s	10 MS/s	2 MS/s
10 hours	10 kS/s	50 kS/s	100 kS/s	1 MS/s
50 days	100 S/s	200 S/s	500 S/s	10 kS/s

1 Up to two channels (one channel per group) can be measured.
 2 For the /M1 model Up to four channels (two channels per group) can be measured.

- To measure over a long time period with the same sample rate, increase the acquisition memory size (/M1, /M2 option) or use SSD recording (/ST1 option).

Example in which the record time is increased without changing the sample rate

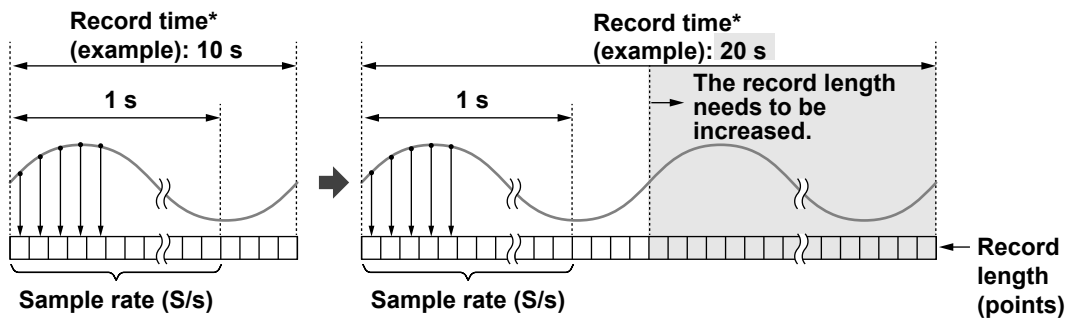

* Time scale (TIME DIV)×10

History Waveform Acquisition Count (Appendix 4, 5, 7)

- If you set the record length to the full memory size per channel (the maximum record length), the history waveform acquisition count will be 1. For the maximum record length, see appendix 4.
- If you shorten the record length, the history waveform acquisition count increases. For the history waveform acquisition count, see appendix 5. For the acquisition count on the high-speed dual capture side, see appendix 7 (the acquisition count on the low-speed side is 1).
- During SSD recording (/ST1 option), the waveform acquisition account is 1 regardless of the record length.

Set Record Length and Display Record Length (Appendix 2)

In Scope mode, the sample rate is calculated using the following equation.

$$\text{Sample rate (S/s)} = \text{Record length (points)} \div (\text{Time scale (TIME/DIV)} \times 10)$$

However, because the sample rate can only take on discrete numbers such as 1 kS/s, 2 kS/s, and 5 kS/s, the actual sample rate is set to the maximum possible sample rate in the set record length.

The record length set at this point is called the *set record length*, and the number of waveform data points acquired at the actual sample rate is called the *display record length*.

In addition, the display record length will be shortened when the setting exceeds the upper limit of the sample rate, such as when the maximum sample rate of the module is reached.

Example of Set Record Length and Display Record Length

Set Record Length	Time Scale (Time/div)	Calculated Sample Rate ¹	Actual Sample Rate	Display Record Length ²
50 kpoint	2 s	2.5 kS/s	2 kS/s	40 kpoint
50 kpoint	1 min	83.333...kS/s	50 kS/s	30 kpoint
1 Mpoint	1 min	1.666...kS/s	1 kS/s	600 kpoint
1 Mpoint	5 hour	555.555...S/s	5 S/s	900 kpoint

1 Calculated sample rate = Set record length \div Time scale (TIME/DIV) \times 10

2 Display record length = Actual sample rate \times Time scale (TIME/DIV) \times 10

The sample rate described in appendix 2 is not the sample rate calculated from the set record length and time scale, but the sample rate that waveforms are acquired at.

Measuring in Recorder Mode

- In Recorder mode, a waveform is acquired by setting a record time and sample interval so that the waveform fits in the memory size per channel. The number of times waveforms are acquired is one.
- The memory size per channel is determined by the total acquisition memory size and the number of channels used. For a description of how to count the number of channels, see page App-5.

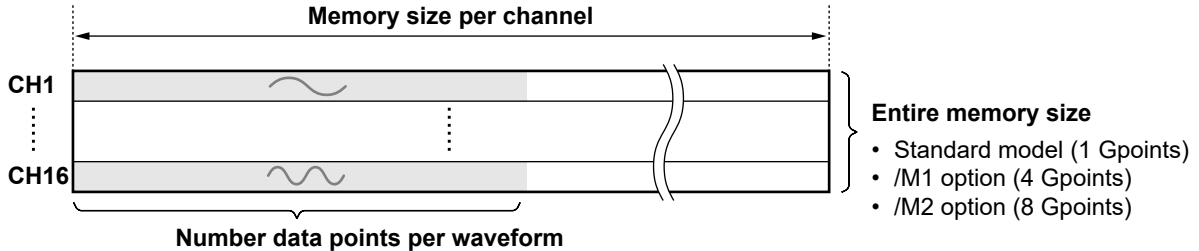

Acquisition/Record Time* and Sample Interval (Appendix 8)

* Acquisition time is a setting for memory recording. Record time is a setting for SSD recording.

- The longer the acquisition/record time or the shorter the sample interval, the greater the number of data points per waveform, so the record time and sample interval must be set so that waveforms fit in the memory size per channel. For the acquisition/record time and sample interval setting ranges, see appendix 8. For the minimum sample interval, see page App-5.

Examples of Measurement Times (Acquisition Times, Recording Times) and Sample Intervals

Measurement Time	Number of Channels and Sample Interval ¹			
	Standard Model	/M1 Model	/M2 Model	SSD Recording ³
	64 (32) ch ²	64 (32) ch ²	64 (32) ch ²	64 (32) ch ²
20 s	2 μs (500 kS/s)	500 ns (2 MS/s)	200 ns (5 MS/s)	20 μs (50 kS/s)
300 s	50 μs (20 kS/s)	10 μs (100 kS/s)	5 μs (200 kS/s)	20 μs (50 kS/s)
10 hours	5 ms (200 S/s)	1 ms (1 kS/s)	500 μs (2 kS/s)	20 μs (50 kS/s)
50 days	-	100 ms (10 S/s)	50 ms (20 S/s)	1 ms (1 kS/s)

1 The values inside parentheses are sample rates.

2 Up to 64 channels (32 channels in memory join group) can be measured.

3 For the /M2 model

- To measure over a long time period with the same sample interval, increase the acquisition memory size (/M1, /M2 option) or use SSD recording (/ST1 option).

Example in which the measurement time is increased without changing the sample interval

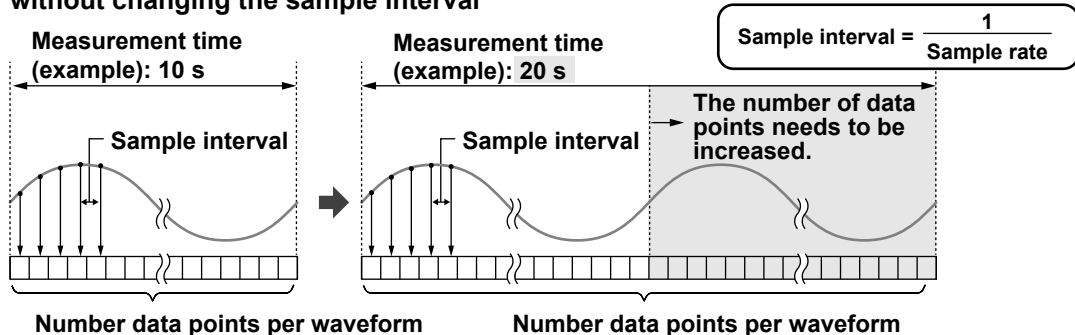

Memory Join Group (Appendix 4, 5, 7, 8)

As shown below, the instrument's acquisition memory consists of two groups, and the channel assignments are fixed for each group.

Group 1

CH1_1	CH1_2	CH2_1	CH2_2
CH5_1	CH5_2	CH6_1	CH6_2
CH9_1	CH9_2	CH10_1	CH10_2
CH13_1	CH13_2	CH14_1	CH14_2
RTmath1		RTmath2	
RTmath5		RTmath6	
RTmath9		RTmath10	
RTmath13		RTmath14	

Group 2

CH3_1	CH3_2	CH4_1	CH4_2
CH7_1	CH7_2	CH8_1	CH8_2
CH11_1	CH11_2	CH12_1	CH12_2
CH15_1	CH15_2	CH16_1	CH16_2
RTmath3		RTmath4	
RTmath7		RTmath8	
RTmath11		RTmath12	
RTmath15		RTmath16	

- Each sub channel of a 4-CH module uses one channel of space.
- In the case of a 16-CH module or in-vehicle bus monitor module, all the sub channels together use one channel of space. One channel space is divided among sub channels.
- RTmath is a real time math channel. It uses two input channels of space.
- In the case of power math and harmonic computation, one channel of RTmath space are divided among sub channels.

How Number of Channels Is Counted

When the number of channels is shown in the appendix, it is converted to one input channel of space. For the space used by each channel, see the memory join group table above.

Channel to Turn on (Example)	Number of Channels		
	Group 1	Group 2	Total
CH1 , CH 2, CH3	2 ch	1 ch	3 ch
CH1 , CH 2, RTmath1	4 ch	0 ch	4 ch
CH1_1 , CH1_2 , CH 2_1, CH2_2 , RTmath3	4 ch	2 ch	6 ch

The maximum number of channels in one group is 32, and the total number of channels in the two groups is 64 (including RTmath channels).

Sample Rate

Maximum Sample Rate (Appendix 2, 6, 8)

The maximum sample rate varies depending on the specifications of the module in use as shown below.

Module (Example)		Sample Rate (Scope Mode) ^{2, 3}		Sample Interval (Recorder Mode) ⁵
Model	Maximum (Specifications) ¹	During Memory Recording	During SSD Recording ⁴	
720212	200 MS/s	200 MS/s	2 MS/s	100 ns (10 MS/s) ⁶
720211	100 MS/s	100 MS/s	2 MS/s	100 ns (10 MS/s) ⁶
720250	10 MS/s	10 MS/s	2 MS/s	100 ns (10 MS/s) ⁶
701251	1 MS/s	1 MS/s	1 MS/s	1 μs (1 MS/s) ⁶
701261	100 kS/s	100 kS/s	100 kS/s	10 μs (100 kS/s) ⁶

You can change the sample rate or sample interval of each channel in channel settings. For details, see page App-6.

- 1 For the maximum sample rate of each module, see the module specifications. When using a combination of modules with different maximum values, the upper limit is the maximum sample rate of each module.
- 2 For a table of sample rates in Scope mode, see appendix 2. The referenced table in appendix 2 varies depending on the maximum sample rate of the module used. The table also varies depending on whether memory recording or SSD recording is used.
- 3 The upper limit of the dual capture's low-speed side is 100 kS/s regardless of the module.
- 4 During SSD recording, the maximum sample rate varies depending on the number of channels in use. For details, see appendix 6.
- 5 This is an example for memory recording. For the sample interval setting range of Recorder mode, see appendix 8. The table in appendix 8 you refer to also varies depending on whether memory recording or SSD recording is used.
- 6 The values inside parentheses are sample rates.

Sub Channel Write Rate (Appendix 3)

The sample rate of sub channels on the 4-CH module is the same as that of the main channels, but the sample rate (write rate) of sub channels on the 16-CH temperature/voltage input module and in-vehicle bus monitor module is not.

For details, see appendix 3.

Channel Setting's Sample Rate and Sample Interval

You can change the sample rate (in Scope mode) or sample interval (in Recorder mode) for each channel.

Scope mode

- The set record length that you set on the ACQUIRE menu and the time scale (TIME/DIV) do not change even if you change the channel setting's sample rate.
- When you decrease the sample rate in the channel settings, the sampled data is decimated, so the number of waveform data points is reduced. This is useful when you want to reduce the waveform data file size.
- On modules whose maximum sample rate is 1 MS/s or less,* the channel setting's sample rate can be set as fast as 10 MS/s (only when a 10 MS/s or faster module is installed). However, it is not possible to set a sample rate faster than that determined by the set record length and time scale. Furthermore, the data is interpolated using the previous sample data, so all the data will be the same during the data update period.
- When dual capture is enabled, the low-speed and high-speed sample rates can be changed.

Recorder Mode

- Changing the sample interval in the channel settings does not change the sample interval set in the ACQUIRE menu.
- When you increase the sample interval in the channel settings, the sampled data is decimated, so the number of waveform data points is reduced. This is useful when you want to reduce the waveform data file size.
- On modules whose maximum sample rate is 1 MS/s or less,* the channel setting's sample interval can be set as short as 100 ns (10 MS/s) (only when a 10 MS/s or faster module is installed). However, the sample interval cannot be set shorter than the sample interval set on the ACQUIRE menu. Furthermore, the data is interpolated using the previous sample data, so all the data will be the same during the data update period.

* On the 16-CH temperature/voltage input module (720221), the sample period cannot be set faster than the sample rate or sample interval determined by the data update interval setting.

Appendix 2 Relationship between the Time Scale, Sample Rate, and Record Length (Scope mode only)

For details on how to use the appendix, see appendix 1, “Using the Appendix.”

Table ID Number

The table in appendix 2 you refer to varies depending on whether memory recording or SSD recording (/ST1 option) is used. The table also varies depending on the module’s maximum sample rate and the set record length.

An identification number is provided at the beginning of each table as shown in [M-1] below.

[M-1]	SSD Recording	OFF (memory recording)
	Module’s maximum sample rate	200 MS/s
	Set record length	10 k, 25 k, 50 k, 100 k, 250 kpoint

Table of ID Numbers

Check the ID number of the table you need to refer to in the following table.

Memory Recording

Module’s Maximum Sample Rate	Set Record Length (Points)			
	10 k, 25 k, 50 k, 100 k, 250 k	500 k, 1 M, 2.5 M, 5 M, 10 M	25 M, 50 M, 100 M, 250 M, 500 M	1 G, 2 G, 4 G
200 MS/s	[M-1]	[M-2]	[M-3]	[M-4]
100 MS/s	[M-5]	[M-6]	[M-7]	[M-8]
10 MS/s	[M-9]	[M-10]	[M-11]	[M-12]
1 MS/s	[M-13]	[M-14]	[M-15]	[M-16]
100 kS/s	[M-17]	[M-18]	[M-19]	[M-20]
All Modules	[M-21]	[M-22]	[M-23]	[M-24]

- When the time scale (Time/div) is 1 hour or more, see [M-21] to [M-24], regardless of the module’s maximum sample rate.
- For the dual capture (high-speed sampling) settings, see [M-1] to [M-3], [M-5] to [M-7], [M-9] to [M-11], [M-13] to [M-15], and [M-17] to [M-19].
- For the dual capture (low-speed side) settings, see [M-18] to [M-20] and [M-22] to [M-24].

SSD Recording

Module’s Maximum Sample Rate	Set Record Length (Points)			
	1 M, 2.5 M, 5 M, 10 M, 25 M	50 M, 100 M, 250 M, 500 M, 1 G	2 G, 4 G, 5 G, 10 G, 20 G	50 G
10 MS/s or more	[S-1]	[S-2]	[S-3]	[S-4]
1 MS/s	[S-5]	[S-6]	[S-7]	[S-8]
100 kS/s	[S-9]	[S-10]	[S-11]	[S-12]

- For the dual capture (low-speed side) settings, see [S-9] to [S-12].
- For SSD recording, the maximum sample rate is limited by the number of channels. For details, see appendix 6.

Memory Recording

Module's Maximum Sample Rate: 200 MS/s

[M-1]	SSD Recording	OFF (memory recording)
	Module's maximum sample rate	200 MS/s
	Set record length	10 k, 25 k, 50 k, 100 k, 250 kpoint

Time/div	Set record length									
	10 kpoint		25 kpoint		50 kpoint		100 kpoint		250 kpoint	
	Sample Rate (S/s)	Display Record Length (Points)	Sample Rate (S/s)	Display Record Length (Points)	Sample Rate (S/s)	Display Record Length (Points)	Sample Rate (S/s)	Display Record Length (Points)	Sample Rate (S/s)	Display Record Length (Points)
100 ns	200 M	200	200 M	200	200 M	200	200 M	200	200 M	200
200 ns	200 M	400	200 M	400	200 M	400	200 M	400	200 M	400
500 ns	200 M	1.0 k	200 M	1.0 k	200 M	1.0 k	200 M	1.0 k	200 M	1.0 k
1 µs	200 M	2.0 k	200 M	2.0 k	200 M	2.0 k	200 M	2.0 k	200 M	2.0 k
2 µs	200 M	4.0 k	200 M	4.0 k	200 M	4.0 k	200 M	4.0 k	200 M	4.0 k
5 µs	200 M	10.0 k	200 M	10.0 k	200 M	10.0 k	200 M	10.0 k	200 M	10.0 k
10 µs	100 M	10.0 k	200 M	20.0 k	200 M	20.0 k	200 M	20.0 k	200 M	20.0 k
20 µs	50 M	10.0 k	100 M	20.0 k	200 M	40.0 k	200 M	40.0 k	200 M	40.0 k
50 µs	20 M	10.0 k	50 M	25.0 k	100 M	50.0 k	200 M	100.0 k	200 M	100.0 k
100 µs	10 M	10.0 k	20 M	20.0 k	50 M	50.0 k	100 M	100.0 k	200 M	200.0 k
200 µs	5 M	10.0 k	10 M	20.0 k	20 M	40.0 k	50 M	100.0 k	100 M	200.0 k
500 µs	2 M	10.0 k	5 M	25.0 k	10 M	50.0 k	20 M	100.0 k	50 M	250.0 k
1 ms	1 M	10.0 k	2 M	20.0 k	5 M	50.0 k	10 M	100.0 k	20 M	200.0 k
2 ms	500 k	10.0 k	1 M	20.0 k	2 M	40.0 k	5 M	100.0 k	10 M	200.0 k
5 ms	200 k	10.0 k	500 k	25.0 k	1 M	50.0 k	2 M	100.0 k	5 M	250.0 k
10 ms	100 k	10.0 k	200 k	20.0 k	500 k	50.0 k	1 M	100.0 k	2 M	200.0 k
20 ms	50 k	10.0 k	100 k	20.0 k	200 k	40.0 k	500 k	100.0 k	1 M	200.0 k
50 ms	20 k	10.0 k	50 k	25.0 k	100 k	50.0 k	200 k	100.0 k	500 k	250.0 k
100 ms	10 k	10.0 k	20 k	20.0 k	50 k	50.0 k	100 k	100.0 k	200 k	200.0 k
200 ms	5 k	10.0 k	10 k	20.0 k	20 k	40.0 k	50 k	100.0 k	100 k	200.0 k
500 ms	2 k	10.0 k	5 k	25.0 k	10 k	50.0 k	20 k	100.0 k	50 k	250.0 k
1 s	1 k	10.0 k	2 k	20.0 k	5 k	50.0 k	10 k	100.0 k	20 k	200.0 k
2 s	500	10.0 k	1 k	20.0 k	2 k	40.0 k	5 k	100.0 k	10 k	200.0 k
3 s	200	6.0 k	500	15.0 k	1 k	30.0 k	2 k	60.0 k	5 k	150.0 k
4 s	200	8.0 k	500	20.0 k	1 k	40.0 k	2 k	80.0 k	5 k	200.0 k
5 s	200	10.0 k	500	25.0 k	1 k	50.0 k	2 k	100.0 k	5 k	250.0 k
6 s	100	6.0 k	200	12.0 k	500	30.0 k	1 k	60.0 k	2 k	120.0 k
10 s	100	10.0 k	200	20.0 k	500	50.0 k	1 k	100.0 k	2 k	200.0 k
20 s	50	10.0 k	100	20.0 k	200	40.0 k	500	100.0 k	1 k	200.0 k
30 s	20	6.0 k	50	15.0 k	100	30.0 k	200	60.0 k	500	150.0 k
1 min	10	6.0 k	20	12.0 k	50	30.0 k	100	60.0 k	200	120.0 k
2 min	5	6.0 k	20	24.0 k	20	24.0 k	50	60.0 k	200	240.0 k
3 min	5	9.0 k	10	18.0 k	20	36.0 k	50	90.0 k	100	180.0 k
4 min	-	-	10	24.0 k	20	48.0 k	20	48.0 k	100	240.0 k
5 min	-	-	5	15.0 k	10	30.0 k	20	60.0 k	50	150.0 k
6 min	-	-	5	18.0 k	10	36.0 k	20	72.0 k	50	180.0 k
10 min	-	-	-	-	5	30.0 k	10	60.0 k	20	120.0 k
12 min	-	-	-	-	5	36.0 k	10	72.0 k	20	144.0 k
30 min	-	-	-	-	-	-	5	90.0 k	10	180.0 k

If Time/div is set to 1 hour or more, see [M-21] All Modules table.

☐: The dual capture (high-speed sampling) setting range.

○: This is referenced in "Examples of Using the Appendix" on page App-1.

If the time scale is set to 100 ms/div or more in scope mode, roll mode display is used when the trigger mode is auto, auto level, single, or on-start.

Appendix 2 Relationship between the Time Scale, Sample Rate, and Record Length (Scope mode only)

[M-2]	SSD Recording	OFF (memory recording)
	Module's maximum sample rate	200 MS/s
	Set record length	500 k, 1 M, 2.5 M, 5 M, 10 Mpoint

Time/div	Set record length									
	500 kpoint		1 Mpoints		2.5 Mpoints		5 Mpoints		10 Mpoints	
	Sample Rate (S/s)	Display Record Length (Points)	Sample Rate (S/s)	Display Record Length (Points)	Sample Rate (S/s)	Display Record Length (Points)	Sample Rate (S/s)	Display Record Length (Points)	Sample Rate (S/s)	Display Record Length (Points)
100 ns	200 M	200	200 M	200	200 M	200	200 M	200	200 M	200
200 ns	200 M	400	200 M	400	200 M	400	200 M	400	200 M	400
500 ns	200 M	1.0 k	200 M	1.0 k	200 M	1.0 k	200 M	1.0 k	200 M	1.0 k
1 μs	200 M	2.0 k	200 M	2.0 k	200 M	2.0 k	200 M	2.0 k	200 M	2.0 k
2 μs	200 M	4.0 k	200 M	4.0 k	200 M	4.0 k	200 M	4.0 k	200 M	4.0 k
5 μs	200 M	10.0 k	200 M	10.0 k	200 M	10.0 k	200 M	10.0 k	200 M	10.0 k
10 μs	200 M	20.0 k	200 M	20.0 k	200 M	20.0 k	200 M	20.0 k	200 M	20.0 k
20 μs	200 M	40.0 k	200 M	40.0 k	200 M	40.0 k	200 M	40.0 k	200 M	40.0 k
50 μs	200 M	100.0 k	200 M	100.0 k	200 M	100.0 k	200 M	100.0 k	200 M	100.0 k
100 μs	200 M	200.0 k	200 M	200.0 k	200 M	200.0 k	200 M	200.0 k	200 M	200.0 k
200 μs	200 M	400.0 k	200 M	400.0 k	200 M	400.0 k	200 M	400.0 k	200 M	400.0 k
500 μs	100 M	500.0 k	200 M	1.0 M	200 M	1.0 M	200 M	1.0 M	200 M	1.0 M
1 ms	50 M	500.0 k	100 M	1.0 M	200 M	2.0 M	200 M	2.0 M	200 M	2.0 M
2 ms	20 M	400.0 k	50 M	1.0 M	100 M	2.0 M	200 M	4.0 M	200 M	4.0 M
5 ms	10 M	500.0 k	20 M	1.0 M	50 M	2.5 M	100 M	5.0 M	200 M	10.0 M
10 ms	5 M	500.0 k	10 M	1.0 M	20 M	2.0 M	50 M	5.0 M	100 M	10.0 M
20 ms	2 M	400.0 k	5 M	1.0 M	10 M	2.0 M	20 M	4.0 M	50 M	10.0 M
50 ms	1 M	500.0 k	2 M	1.0 M	5 M	2.5 M	10 M	5.0 M	20 M	10.0 M
100 ms	500 k	500.0 k	1 M	1.0 M	2 M	2.0 M	5 M	5.0 M	10 M	10.0 M
200 ms	200 k	400.0 k	500 k	1.0 M	1 M	2.0 M	2 M	4.0 M	5 M	10.0 M
500 ms	100 k	500.0 k	200 k	1.0 M	500 k	2.5 M	1 M	5.0 M	2 M	10.0 M
1 s	50 k	500.0 k	100 k	1.0 M	200 k	2.0 M	500 k	5.0 M	1 M	10.0 M
2 s	20 k	400.0 k	50 k	1.0 M	100 k	2.0 M	200 k	4.0 M	500 k	10.0 M
3 s	10 k	300.0 k	20 k	600.0 k	50 k	1.5 M	100 k	3.0 M	200 k	6.0 M
4 s	10 k	400.0 k	20 k	800.0 k	50 k	2.0 M	100 k	4.0 M	200 k	8.0 M
5 s	10 k	500.0 k	20 k	1.0 M	50 k	2.5 M	100 k	5.0 M	200 k	10.0 M
6 s	5 k	300.0 k	10 k	600.0 k	20 k	1.2 M	50 k	3.0 M	100 k	6.0 M
10 s	5 k	500.0 k	10 k	1.0 M	20 k	2.0 M	50 k	5.0 M	100 k	10.0 M
20 s	2 k	400.0 k	5 k	1.0 M	10 k	2.0 M	20 k	4.0 M	50 k	10.0 M
30 s	1 k	300.0 k	2 k	600.0 k	5 k	1.5 M	10 k	3.0 M	20 k	6.0 M
1 min	500	300.0 k	1 k	600.0 k	2 k	1.2 M	5 k	3.0 M	10 k	6.0 M
2 min	200	240.0 k	500	600.0 k	2 k	2.4 M	2 k	2.4 M	5 k	6.0 M
3 min	200	360.0 k	500	900.0 k	1 k	1.8 M	2 k	3.6 M	5 k	9.0 M
4 min	200	480.0 k	200	480.0 k	1 k	2.4 M	2 k	4.8 M	2 k	4.8 M
5 min	100	300.0 k	200	600.0 k	500	1.5 M	1 k	3.0 M	2 k	6.0 M
6 min	100	360.0 k	200	720.0 k	500	1.8 M	1 k	3.6 M	2 k	7.2 M
10 min	50	300.0 k	100	600.0 k	200	1.2 M	500	3.0 M	1 k	6.0 M
12 min	50	360.0 k	100	720.0 k	200	1.4 M	500	3.6 M	1 k	7.2 M
30 min	20	360.0 k	50	900.0 k	100	1.8 M	200	3.6 M	500	9.0 M

If Time/div is set to 1 hour or more, see [M-22] All Modules table.

: The dual capture (high-speed sampling) setting range.

If the time scale is set to 100 ms/div or more in scope mode, roll mode display is used when the trigger mode is auto, auto level, single, or on-start.

Appendix 2 Relationship between the Time Scale, Sample Rate, and Record Length (Scope mode only)

[M-3]	SSD Recording	OFF (memory recording)
	Module's maximum sample rate	200 MS/s
	Set record length	25 M, 50 M, 100 M, 250 M, 500 Mpoint

Time/div	Set record length									
	25 Mpoints		50 Mpoints		100 Mpoints		250 Mpoints		500 Mpoints	
	Sample Rate (S/s)	Display Record Length (Points)	Sample Rate (S/s)	Display Record Length (Points)	Sample Rate (S/s)	Display Record Length (Points)	Sample Rate (S/s)	Display Record Length (Points)	Sample Rate (S/s)	Display Record Length (Points)
100 ns	200 M	200	200 M	200	200 M	200	200 M	200	200 M	200
200 ns	200 M	400	200 M	400	200 M	400	200 M	400	200 M	400
500 ns	200 M	1.0 k	200 M	1.0 k	200 M	1.0 k	200 M	1.0 k	200 M	1.0 k
1 µs	200 M	2.0 k	200 M	2.0 k	200 M	2.0 k	200 M	2.0 k	200 M	2.0 k
2 µs	200 M	4.0 k	200 M	4.0 k	200 M	4.0 k	200 M	4.0 k	200 M	4.0 k
5 µs	200 M	10.0 k	200 M	10.0 k	200 M	10.0 k	200 M	10.0 k	200 M	10.0 k
10 µs	200 M	20.0 k	200 M	20.0 k	200 M	20.0 k	200 M	20.0 k	200 M	20.0 k
20 µs	200 M	40.0 k	200 M	40.0 k	200 M	40.0 k	200 M	40.0 k	200 M	40.0 k
50 µs	200 M	100.0 k	200 M	100.0 k	200 M	100.0 k	200 M	100.0 k	200 M	100.0 k
100 µs	200 M	200.0 k	200 M	200.0 k	200 M	200.0 k	200 M	200.0 k	200 M	200.0 k
200 µs	200 M	400.0 k	200 M	400.0 k	200 M	400.0 k	200 M	400.0 k	200 M	400.0 k
500 µs	200 M	1.0 M	200 M	1.0 M	200 M	1.0 M	200 M	1.0 M	200 M	1.0 M
1 ms	200 M	2.0 M	200 M	2.0 M	200 M	2.0 M	200 M	2.0 M	200 M	2.0 M
2 ms	200 M	4.0 M	200 M	4.0 M	200 M	4.0 M	200 M	4.0 M	200 M	4.0 M
5 ms	200 M	10.0 M	200 M	10.0 M	200 M	10.0 M	200 M	10.0 M	200 M	10.0 M
10 ms	200 M	20.0 M	200 M	20.0 M	200 M	20.0 M	200 M	20.0 M	200 M	20.0 M
20 ms	100 M	20.0 M	200 M	40.0 M	200 M	40.0 M	200 M	40.0 M	200 M	40.0 M
50 ms	50 M	25.0 M	100 M	50.0 M	200 M	100.0 M	200 M	100.0 M	200 M	100.0 M
100 ms	20 M	20.0 M	50 M	50.0 M	100 M	100.0 M	200 M	200.0 M	200 M	200.0 M
200 ms	10 M	20.0 M	20 M	40.0 M	50 M	100.0 M	100 M	200.0 M	200 M	400.0 M
500 ms	5 M	25.0 M	10 M	50.0 M	20 M	100.0 M	50 M	250.0 M	100 M	500.0 M
1 s	2 M	20.0 M	5 M	50.0 M	10 M	100.0 M	20 M	200.0 M	50 M	500.0 M
2 s	1 M	20.0 M	2 M	40.0 M	5 M	100.0 M	10 M	200.0 M	20 M	400.0 M
3 s	500 k	15.0 M	1 M	30.0 M	2 M	60.0 M	5 M	150.0 M	10 M	300.0 M
4 s	500 k	20.0 M	1 M	40.0 M	2 M	80.0 M	5 M	200.0 M	10 M	400.0 M
5 s	500 k	25.0 M	1 M	50.0 M	2 M	100.0 M	5 M	250.0 M	10 M	500.0 M
6 s	200 k	12.0 M	500 k	30.0 M	1 M	60.0 M	2 M	120.0 M	5 M	300.0 M
10 s	200 k	20.0 M	500 k	50.0 M	1 M	100.0 M	2 M	200.0 M	5 M	500.0 M
20 s	100 k	20.0 M	200 k	40.0 M	500 k	100.0 M	1 M	200.0 M	2 M	400.0 M
30 s	50 k	15.0 M	100 k	30.0 M	200 k	60.0 M	500 k	150.0 M	1 M	300.0 M
1 min	20 k	12.0 M	50 k	30.0 M	100 k	60.0 M	200 k	120.0 M	500 k	300.0 M
2 min	20 k	24.0 M	20 k	24.0 M	50 k	60.0 M	200 k	240.0 M	200 k	240.0 M
3 min	10 k	18.0 M	20 k	36.0 M	50 k	90.0 M	100 k	180.0 M	200 k	360.0 M
4 min	10 k	24.0 M	20 k	48.0 M	20 k	48.0 M	100 k	240.0 M	200 k	480.0 M
5 min	5 k	15.0 M	10 k	30.0 M	20 k	60.0 M	50 k	150.0 M	100 k	300.0 M
6 min	5 k	18.0 M	10 k	36.0 M	20 k	72.0 M	50 k	180.0 M	100 k	360.0 M
10 min	2 k	12.0 M	5 k	30.0 M	10 k	60.0 M	20 k	120.0 M	50 k	300.0 M
12 min	2 k	14.4 M	5 k	36.0 M	10 k	72.0 M	20 k	144.0 M	50 k	360.0 M
30 min	1 k	18.0 M	2 k	36.0 M	5 k	90.0 M	10 k	180.0 M	20 k	360.0 M

If Time/div is set to 1 hour or more, see [M-23] All Modules table.

■: The dual capture (high-speed sampling) setting range.

○: This is referenced in "Examples of Using the Appendix" on page App-1.

If the time scale is set to 100 ms/div or more in scope mode, roll mode display is used when the trigger mode is auto, auto level, single, or on-start.

Appendix 2 Relationship between the Time Scale, Sample Rate, and Record Length (Scope mode only)

[M-4]	SSD Recording	OFF (memory recording)
	Module's maximum sample rate	200 MS/s
	Set record length	1 G, 2 G, 4 Gpoint

Time/div	Set record length					
	1 Gpoint		2 Gpoint		4 Gpoint	
	Sample Rate (S/s)	Display Record Length (Points)	Sample Rate (S/s)	Display Record Length (Points)	Sample Rate (S/s)	Display Record Length (Points)
100 ns	200 M	200	200 M	200	200 M	200
200 ns	200 M	400	200 M	400	200 M	400
500 ns	200 M	1.0 k	200 M	1.0 k	200 M	1.0 k
1 μs	200 M	2.0 k	200 M	2.0 k	200 M	2.0 k
2 μs	200 M	4.0 k	200 M	4.0 k	200 M	4.0 k
5 μs	200 M	10.0 k	200 M	10.0 k	200 M	10.0 k
10 μs	200 M	20.0 k	200 M	20.0 k	200 M	20.0 k
20 μs	200 M	40.0 k	200 M	40.0 k	200 M	40.0 k
50 μs	200 M	100.0 k	200 M	100.0 k	200 M	100.0 k
100 μs	200 M	200.0 k	200 M	200.0 k	200 M	200.0 k
200 μs	200 M	400.0 k	200 M	400.0 k	200 M	400.0 k
500 μs	200 M	1.0 M	200 M	1.0 M	200 M	1.0 M
1 ms	200 M	2.0 M	200 M	2.0 M	200 M	2.0 M
2 ms	200 M	4.0 M	200 M	4.0 M	200 M	4.0 M
5 ms	200 M	10.0 M	200 M	10.0 M	200 M	10.0 M
10 ms	200 M	20.0 M	200 M	20.0 M	200 M	20.0 M
20 ms	200 M	40.0 M	200 M	40.0 M	200 M	40.0 M
50 ms	200 M	100.0 M	200 M	100.0 M	200 M	100.0 M
100 ms	200 M	200.0 M	200 M	200.0 M	200 M	200.0 M
200 ms	200 M	400.0 M	200 M	400.0 M	200 M	400.0 M
500 ms	200 M	1.0 G	200 M	1.0 G	200 M	1.0 G
1 s	100 M	1.0 G	200 M	2.0 G	200 M	2.0 G
2 s	50 M	1.0 G	100 M	2.0 G	200 M	4.0 G
3 s	20 M	600.0 M	50 M	1.5 G	100 M	3.0 G
4 s	20 M	800.0 M	50 M	2.0 G	100 M	4.0 G
5 s	20 M	1.0 G	20 M	1.0 G	50 M	2.5 G
6 s	10 M	600.0 M	20 M	1.2 G	50 M	3.0 G
10 s	10 M	1.0 G	20 M	2.0 G	20 M	2.0 G
20 s	5 M	1.0 G	10 M	2.0 G	20 M	4.0 G
30 s	2 M	600.0 M	5 M	1.5 G	10 M	3.0 G
1 min	1 M	600.0 M	2 M	1.5 G	5 M	3.0 G
2 min	500 k	600.0 M	1 M	1.2 G	2 M	2.4 G
3 min	500 k	900.0 M	1 M	1.8 G	2 M	3.6 G
4 min	200 k	480.0 M	500 k	1.2 G	1 M	2.4 G
5 min	200 k	600.0 M	500 k	1.5 G	1 M	3 G
6 min	200 k	720.0 M	500 k	1.8 G	1 M	3.6 G
10 min	100 k	600.0 M	200 k	1.2 G	500 k	3 G
12 min	100 k	720.0 M	200 k	1.44 G	500 k	3.6 G
30 min	50 k	900.0 M	100 k	1.8 G	200 k	3.6 G

If Time/div is set to 1 hour or more, see [M-24] All Modules table.

If the time scale is set to 100 ms/div or more in scope mode, roll mode display is used when the trigger mode is auto, auto level, single, or on-start.

Module's Maximum Sample Rate: 100 MS/s

[M-5]	SSD Recording	OFF (memory recording)
	Module's maximum sample rate	100 MS/s
	Set record length	10 k, 25 k, 50 k, 100 k, 250 kpoint

Time/div	Set record length									
	10 kpoint		25 kpoint		50 kpoint		100 kpoint		250 kpoint	
	Sample Rate (S/s)	Display Record Length (Points)	Sample Rate (S/s)	Display Record Length (Points)	Sample Rate (S/s)	Display Record Length (Points)	Sample Rate (S/s)	Display Record Length (Points)	Sample Rate (S/s)	Display Record Length (Points)
100 ns	100 M	100	100 M	100	100 M	100	100 M	100	100 M	100
200 ns	100 M	200	100 M	200	100 M	200	100 M	200	100 M	200
500 ns	100 M	500	100 M	500	100 M	500	100 M	500	100 M	500
1 µs	100 M	1.0 k	100 M	1.0 k	100 M	1.0 k	100 M	1.0 k	100 M	1.0 k
2 µs	100 M	2.0 k	100 M	2.0 k	100 M	2.0 k	100 M	2.0 k	100 M	2.0 k
5 µs	100 M	5.0 k	100 M	5.0 k	100 M	5.0 k	100 M	5.0 k	100 M	5.0 k
10 µs	100 M	10.0 k	100 M	10.0 k	100 M	10.0 k	100 M	10.0 k	100 M	10.0 k
20 µs	50 M	10.0 k	100 M	20.0 k	100 M	20.0 k	100 M	20.0 k	100 M	20.0 k
50 µs	20 M	10.0 k	50 M	25.0 k	100 M	50.0 k	100 M	50.0 k	100 M	50.0 k
100 µs	10 M	10.0 k	20 M	20.0 k	50 M	50.0 k	100 M	100.0 k	100 M	100.0 k
200 µs	5 M	10.0 k	10 M	20.0 k	20 M	40.0 k	50 M	100.0 k	100 M	200.0 k
500 µs	2 M	10.0 k	5 M	25.0 k	10 M	50.0 k	20 M	100.0 k	50 M	250.0 k
1 ms	1 M	10.0 k	2 M	20.0 k	5 M	50.0 k	10 M	100.0 k	20 M	200.0 k
2 ms	500 k	10.0 k	1 M	20.0 k	2 M	40.0 k	5 M	100.0 k	10 M	200.0 k
5 ms	200 k	10.0 k	500 k	25.0 k	1 M	50.0 k	2 M	100.0 k	5 M	250.0 k
10 ms	100 k	10.0 k	200 k	20.0 k	500 k	50.0 k	1 M	100.0 k	2 M	200.0 k
20 ms	50 k	10.0 k	100 k	20.0 k	200 k	40.0 k	500 k	100.0 k	1 M	200.0 k
50 ms	20 k	10.0 k	50 k	25.0 k	100 k	50.0 k	200 k	100.0 k	500 k	250.0 k
100 ms	10 k	10.0 k	20 k	20.0 k	50 k	50.0 k	100 k	100.0 k	200 k	200.0 k
200 ms	5 k	10.0 k	10 k	20.0 k	20 k	40.0 k	50 k	100.0 k	100 k	200.0 k
500 ms	2 k	10.0 k	5 k	25.0 k	10 k	50.0 k	20 k	100.0 k	50 k	250.0 k
1 s	1 k	10.0 k	2 k	20.0 k	5 k	50.0 k	10 k	100.0 k	20 k	200.0 k
2 s	500	10.0 k	1 k	20.0 k	2 k	40.0 k	5 k	100.0 k	10 k	200.0 k
3 s	200	6.0 k	500	15.0 k	1 k	30.0 k	2 k	60.0 k	5 k	150.0 k
4 s	200	8.0 k	500	20.0 k	1 k	40.0 k	2 k	80.0 k	5 k	200.0 k
5 s	200	10.0 k	500	25.0 k	1 k	50.0 k	2 k	100.0 k	5 k	250.0 k
6 s	100	6.0 k	200	12.0 k	500	30.0 k	1 k	60.0 k	2 k	120.0 k
10 s	100	10.0 k	200	20.0 k	500	50.0 k	1 k	100.0 k	2 k	200.0 k
20 s	50	10.0 k	100	20.0 k	200	40.0 k	500	100.0 k	1 k	200.0 k
30 s	20	6.0 k	50	15.0 k	100	30.0 k	200	60.0 k	500	150.0 k
1 min	10	6.0 k	20	12.0 k	50	30.0 k	100	60.0 k	200	120.0 k
2 min	5	6.0 k	20	24.0 k	20	24.0 k	50	60.0 k	200	240.0 k
3 min	5	9.0 k	10	18.0 k	20	36.0 k	50	90.0 k	100	180.0 k
4 min	-	-	10	24.0 k	20	48.0 k	20	48.0 k	100	240.0 k
5 min	-	-	5	15.0 k	10	30.0 k	20	60.0 k	50	150.0 k
6 min	-	-	5	18.0 k	10	36.0 k	20	72.0 k	50	180.0 k
10 min	-	-	-	-	5	30.0 k	10	60.0 k	20	120.0 k
12 min	-	-	-	-	5	36.0 k	10	72.0 k	20	144.0 k
30 min	-	-	-	-	-	-	5	90.0 k	10	180.0 k

If Time/div is set to 1 hour or more, see [M-21] All Modules table.

: The dual capture (high-speed sampling) setting range.

If the time scale is set to 100 ms/div or more in scope mode, roll mode display is used when the trigger mode is auto, auto level, single, or on-start.

Appendix 2 Relationship between the Time Scale, Sample Rate, and Record Length (Scope mode only)

[M-6]	SSD Recording	OFF (memory recording)
	Module's maximum sample rate	100 MS/s
	Set record length	500 k, 1 M, 2.5 M, 5 M, 10 Mpoint

Time/div	Set record length									
	500 kpoint		1 Mpoints		2.5 Mpoints		5 Mpoints		10 Mpoints	
	Sample Rate (S/s)	Display Record Length (Points)	Sample Rate (S/s)	Display Record Length (Points)	Sample Rate (S/s)	Display Record Length (Points)	Sample Rate (S/s)	Display Record Length (Points)	Sample Rate (S/s)	Display Record Length (Points)
100 ns	100 M	100	100 M	100	100 M	100	100 M	100	100 M	100
200 ns	100 M	200	100 M	200	100 M	200	100 M	200	100 M	200
500 ns	100 M	500	100 M	500	100 M	500	100 M	500	100 M	500
1 μs	100 M	1.0 k	100 M	1.0 k	100 M	1.0 k	100 M	1.0 k	100 M	1.0 k
2 μs	100 M	2.0 k	100 M	2.0 k	100 M	2.0 k	100 M	2.0 k	100 M	2.0 k
5 μs	100 M	5.0 k	100 M	5.0 k	100 M	5.0 k	100 M	5.0 k	100 M	5.0 k
10 μs	100 M	10.0 k	100 M	10.0 k	100 M	10.0 k	100 M	10.0 k	100 M	10.0 k
20 μs	100 M	20.0 k	100 M	20.0 k	100 M	20.0 k	100 M	20.0 k	100 M	20.0 k
50 μs	100 M	50.0 k	100 M	50.0 k	100 M	50.0 k	100 M	50.0 k	100 M	50.0 k
100 μs	100 M	100.0 k	100 M	100.0 k	100 M	100.0 k	100 M	100.0 k	100 M	100.0 k
200 μs	100 M	200.0 k	100 M	200.0 k	100 M	200.0 k	100 M	200.0 k	100 M	200.0 k
500 μs	100 M	500.0 k	100 M	500.0 k	100 M	500.0 k	100 M	500.0 k	100 M	500.0 k
1 ms	50 M	500.0 k	100 M	1.0 M	100 M	1.0 M	100 M	1.0 M	100 M	1.0 M
2 ms	20 M	400.0 k	50 M	1.0 M	100 M	2.0 M	100 M	2.0 M	100 M	2.0 M
5 ms	10 M	500.0 k	20 M	1.0 M	50 M	2.5 M	100 M	5.0 M	100 M	5.0 M
10 ms	5 M	500.0 k	10 M	1.0 M	20 M	2.0 M	50 M	5.0 M	100 M	10.0 M
20 ms	2 M	400.0 k	5 M	1.0 M	10 M	2.0 M	20 M	4.0 M	50 M	10.0 M
50 ms	1 M	500.0 k	2 M	1.0 M	5 M	2.5 M	10 M	5.0 M	20 M	10.0 M
100 ms	500 k	500.0 k	1 M	1.0 M	2 M	2.0 M	5 M	5.0 M	10 M	10.0 M
200 ms	200 k	400.0 k	500 k	1.0 M	1 M	2.0 M	2 M	4.0 M	5 M	10.0 M
500 ms	100 k	500.0 k	200 k	1.0 M	500 k	2.5 M	1 M	5.0 M	2 M	10.0 M
1 s	50 k	500.0 k	100 k	1.0 M	200 k	2.0 M	500 k	5.0 M	1 M	10.0 M
2 s	20 k	400.0 k	50 k	1.0 M	100 k	2.0 M	200 k	4.0 M	500 k	10.0 M
3 s	10 k	300.0 k	20 k	600.0 k	50 k	1.5 M	100 k	3.0 M	200 k	6.0 M
4 s	10 k	400.0 k	20 k	800.0 k	50 k	2.0 M	100 k	4.0 M	200 k	8.0 M
5 s	10 k	500.0 k	20 k	1.0 M	50 k	2.5 M	100 k	5.0 M	200 k	10.0 M
6 s	5 k	300.0 k	10 k	600.0 k	20 k	1.2 M	50 k	3.0 M	100 k	6.0 M
10 s	5 k	500.0 k	10 k	1.0 M	20 k	2.0 M	50 k	5.0 M	100 k	10.0 M
20 s	2 k	400.0 k	5 k	1.0 M	10 k	2.0 M	20 k	4.0 M	50 k	10.0 M
30 s	1 k	300.0 k	2 k	600.0 k	5 k	1.5 M	10 k	3.0 M	20 k	6.0 M
1 min	500	300.0 k	1 k	600.0 k	2 k	1.2 M	5 k	3.0 M	10 k	6.0 M
2 min	200	240.0 k	500	600.0 k	2 k	2.4 M	2 k	2.4 M	5 k	6.0 M
3 min	200	360.0 k	500	900.0 k	1 k	1.8 M	2 k	3.6 M	5 k	9.0 M
4 min	200	480.0 k	200	480.0 k	1 k	2.4 M	2 k	4.8 M	2 k	4.8 M
5 min	100	300.0 k	200	600.0 k	500	1.5 M	1 k	3.0 M	2 k	6.0 M
6 min	100	360.0 k	200	720.0 k	500	1.8 M	1 k	3.6 M	2 k	7.2 M
10 min	50	300.0 k	100	600.0 k	200	1.2 M	500	3.0 M	1 k	6.0 M
12 min	50	360.0 k	100	720.0 k	200	1.4 M	500	3.6 M	1 k	7.2 M
30 min	20	360.0 k	50	900.0 k	100	1.8 M	200	3.6 M	500	9.0 M

If Time/div is set to 1 hour or more, see [M-22] All Modules table.

: The dual capture (high-speed sampling) setting range.

If the time scale is set to 100 ms/div or more in scope mode, roll mode display is used when the trigger mode is auto, auto level, single, or on-start.

Appendix 2 Relationship between the Time Scale, Sample Rate, and Record Length (Scope mode only)

[M-7]	SSD Recording	OFF (memory recording)
	Module's maximum sample rate	100 MS/s
	Set record length	25 M, 50 M, 100 M, 250 M, 500 Mpoint

Time/div	Set record length									
	25 Mpoints		50 Mpoints		100 Mpoints		250 Mpoints		500 Mpoints	
	Sample Rate (S/s)	Display Record Length (Points)	Sample Rate (S/s)	Display Record Length (Points)	Sample Rate (S/s)	Display Record Length (Points)	Sample Rate (S/s)	Display Record Length (Points)	Sample Rate (S/s)	Display Record Length (Points)
100 ns	100 M	100	100 M	100	100 M	100	100 M	100	100 M	100
200 ns	100 M	200	100 M	200	100 M	200	100 M	200	100 M	200
500 ns	100 M	500	100 M	500	100 M	500	100 M	500	100 M	500
1 µs	100 M	1.0 k	100 M	1.0 k	100 M	1.0 k	100 M	1.0 k	100 M	1.0 k
2 µs	100 M	2.0 k	100 M	2.0 k	100 M	2.0 k	100 M	2.0 k	100 M	2.0 k
5 µs	100 M	5.0 k	100 M	5.0 k	100 M	5.0 k	100 M	5.0 k	100 M	5.0 k
10 µs	100 M	10.0 k	100 M	10.0 k	100 M	10.0 k	100 M	10.0 k	100 M	10.0 k
20 µs	100 M	20.0 k	100 M	20.0 k	100 M	20.0 k	100 M	20.0 k	100 M	20.0 k
50 µs	100 M	50.0 k	100 M	50.0 k	100 M	50.0 k	100 M	50.0 k	100 M	50.0 k
100 µs	100 M	100.0 k	100 M	100.0 k	100 M	100.0 k	100 M	100.0 k	100 M	100.0 k
200 µs	100 M	200.0 k	100 M	200.0 k	100 M	200.0 k	100 M	200.0 k	100 M	200.0 k
500 µs	100 M	500.0 k	100 M	500.0 k	100 M	500.0 k	100 M	500.0 k	100 M	500.0 k
1 ms	100 M	1.0 M	100 M	1.0 M	100 M	1.0 M	100 M	1.0 M	100 M	1.0 M
2 ms	100 M	2.0 M	100 M	2.0 M	100 M	2.0 M	100 M	2.0 M	100 M	2.0 M
5 ms	100 M	5.0 M	100 M	5.0 M	100 M	5.0 M	100 M	5.0 M	100 M	5.0 M
10 ms	100 M	10.0 M	100 M	10.0 M	100 M	10.0 M	100 M	10.0 M	100 M	10.0 M
20 ms	100 M	20.0 M	100 M	20.0 M	100 M	20.0 M	100 M	20.0 M	100 M	20.0 M
50 ms	50 M	25.0 M	100 M	50.0 M	100 M	50.0 M	100 M	50.0 M	100 M	50.0 M
100 ms	20 M	20.0 M	50 M	50.0 M	100 M	100.0 M	100 M	100.0 M	100 M	100.0 M
200 ms	10 M	20.0 M	20 M	40.0 M	50 M	100.0 M	100 M	200.0 M	100 M	200.0 M
500 ms	5 M	25.0 M	10 M	50.0 M	20 M	100.0 M	50 M	250.0 M	100 M	500.0 M
1 s	2 M	20.0 M	5 M	50.0 M	10 M	100.0 M	20 M	200.0 M	50 M	500.0 M
2 s	1 M	20.0 M	2 M	40.0 M	5 M	100.0 M	10 M	200.0 M	20 M	400.0 M
3 s	500 k	15.0 M	1 M	30.0 M	2 M	60.0 M	5 M	150.0 M	10 M	300.0 M
4 s	500 k	20.0 M	1 M	40.0 M	2 M	80.0 M	5 M	200.0 M	10 M	400.0 M
5 s	500 k	25.0 M	1 M	50.0 M	2 M	100.0 M	5 M	250.0 M	10 M	500.0 M
6 s	200 k	12.0 M	500 k	30.0 M	1 M	60.0 M	2 M	120.0 M	5 M	300.0 M
10 s	200 k	20.0 M	500 k	50.0 M	1 M	100.0 M	2 M	200.0 M	5 M	500.0 M
20 s	100 k	20.0 M	200 k	40.0 M	500 k	100.0 M	1 M	200.0 M	2 M	400.0 M
30 s	50 k	15.0 M	100 k	30.0 M	200 k	60.0 M	500 k	150.0 M	1 M	300.0 M
1 min	20 k	12.0 M	50 k	30.0 M	100 k	60.0 M	200 k	120.0 M	500 k	300.0 M
2 min	20 k	24.0 M	20 k	24.0 M	50 k	60.0 M	200 k	240.0 M	200 k	240.0 M
3 min	10 k	18.0 M	20 k	36.0 M	50 k	90.0 M	100 k	180.0 M	200 k	360.0 M
4 min	10 k	24.0 M	20 k	48.0 M	20 k	48.0 M	100 k	240.0 M	200 k	480.0 M
5 min	5 k	15.0 M	10 k	30.0 M	20 k	60.0 M	50 k	150.0 M	100 k	300.0 M
6 min	5 k	18.0 M	10 k	36.0 M	20 k	72.0 M	50 k	180.0 M	100 k	360.0 M
10 min	2 k	12.0 M	5 k	30.0 M	10 k	60.0 M	20 k	120.0 M	50 k	300.0 M
12 min	2 k	14.4 M	5 k	36.0 M	10 k	72.0 M	20 k	144.0 M	50 k	360.0 M
30 min	1 k	18.0 M	2 k	36.0 M	5 k	90.0 M	10 k	180.0 M	20 k	360.0 M

If Time/div is set to 1 hour or more, see [M-23] All Modules table.

 : The dual capture (high-speed sampling) setting range.

If the time scale is set to 100 ms/div or more in scope mode, roll mode display is used when the trigger mode is auto, auto level, single, or on-start.

Appendix 2 Relationship between the Time Scale, Sample Rate, and Record Length (Scope mode only)

[M-8]	SSD Recording	OFF (memory recording)
	Module's maximum sample rate	100 MS/s
	Set record length	1 G, 2 G, 4 Gpoint

Time/div	Set record length					
	1 Gpoint		2 Gpoint		4 Gpoint	
	Sample Rate (S/s)	Display Record Length (Points)	Sample Rate (S/s)	Display Record Length (Points)	Sample Rate (S/s)	Display Record Length (Points)
100 ns	100 M	100	100 M	100	100 M	100
200 ns	100 M	200	100 M	200	100 M	200
500 ns	100 M	500	100 M	500	100 M	500
1 μ s	100 M	1.0 k	100 M	1.0 k	100 M	1.0 k
2 μ s	100 M	2.0 k	100 M	2.0 k	100 M	2.0 k
5 μ s	100 M	5.0 k	100 M	5.0 k	100 M	5.0 k
10 μ s	100 M	10.0 k	100 M	10.0 k	100 M	10.0 k
20 μ s	100 M	20.0 k	100 M	20.0 k	100 M	20.0 k
50 μ s	100 M	50.0 k	100 M	50.0 k	100 M	50.0 k
100 μ s	100 M	100.0 k	100 M	100.0 k	100 M	100.0 k
200 μ s	100 M	200.0 k	100 M	200.0 k	100 M	200.0 k
500 μ s	100 M	500.0 k	100 M	500.0 k	100 M	500.0 k
1 ms	100 M	1.0 M	100 M	1.0 M	100 M	1.0 M
2 ms	100 M	2.0 M	100 M	2.0 M	100 M	2.0 M
5 ms	100 M	5.0 M	100 M	5.0 M	100 M	5.0 M
10 ms	100 M	10.0 M	100 M	10.0 M	100 M	10.0 M
20 ms	100 M	20.0 M	100 M	20.0 M	100 M	20.0 M
50 ms	100 M	50.0 M	100 M	50.0 M	100 M	50.0 M
100 ms	100 M	100.0 M	100 M	100.0 M	100 M	100.0 M
200 ms	100 M	200.0 M	100 M	200.0 M	100 M	200.0 M
500 ms	100 M	500.0 M	100 M	500.0 M	100 M	500.0 M
1 s	100 M	1.0 G	100 M	1.0 G	100 M	1.0 G
2 s	50 M	1.0 G	100 M	2.0 G	100 M	2.0 G
3 s	20 M	600.0 M	50 M	1.5 G	100 M	3.0 G
4 s	20 M	800.0 M	50 M	2.0 G	100 M	4.0 G
5 s	20 M	1.0 G	20 M	1.0 G	50 M	2.5 G
6 s	10 M	600.0 M	20 M	1.2 G	50 M	3.0 G
10 s	10 M	1.0 G	20 M	2.0 G	20 M	2.0 G
20 s	5 M	1.0 G	10 M	2.0 G	20 M	4.0 G
30 s	2 M	600.0 M	5 M	1.5 G	10 M	3.0 G
1 min	1 M	600.0 M	2 M	1.5 G	5 M	3.0 G
2 min	500 k	600.0 M	1 M	1.2 G	2 M	2.4 G
3 min	500 k	900.0 M	1 M	1.8 G	2 M	3.6 G
4 min	200 k	480.0 M	500 k	1.2 G	1 M	2.4 G
5 min	200 k	600.0 M	500 k	1.5 G	1 M	3 G
6 min	200 k	720.0 M	500 k	1.8 G	1 M	3.6 G
10 min	100 k	600.0 M	200 k	1.2 G	500 k	3 G
12 min	100 k	720.0 M	200 k	1.44 G	500 k	3.6 G
30 min	50 k	900.0 M	100 k	1.8 G	200 k	3.6 G

If Time/div is set to 1 hour or more, see [M-24] All Modules table.

If the time scale is set to 100 ms/div or more in scope mode, roll mode display is used when the trigger mode is auto, auto level, single, or on-start.

Module's Maximum Sample Rate: 10 MS/s

[M-9]	SSD Recording	OFF (memory recording)
	Module's maximum sample rate	10 MS/s
	Set record length	10 k, 25 k, 50 k, 100 k, 250 kpoint

Time/div	Set record length									
	10 kpoint		25 kpoint		50 kpoint		100 kpoint		250 kpoint	
	Sample Rate (S/s)	Display Record Length (Points)	Sample Rate (S/s)	Display Record Length (Points)	Sample Rate (S/s)	Display Record Length (Points)	Sample Rate (S/s)	Display Record Length (Points)	Sample Rate (S/s)	Display Record Length (Points)
1 μs	10 M	100	10 M	100	10 M	100	10 M	100	10 M	100
2 μs	10 M	200	10 M	200	10 M	200	10 M	200	10 M	200
5 μs	10 M	500	10 M	500	10 M	500	10 M	500	10 M	500
10 μs	10 M	1.0 k	10 M	1.0 k	10 M	1.0 k	10 M	1.0 k	10 M	1.0 k
20 μs	10 M	2.0 k	10 M	2.0 k	10 M	2.0 k	10 M	2.0 k	10 M	2.0 k
50 μs	10 M	5.0 k	10 M	5.0 k	10 M	5.0 k	10 M	5.0 k	10 M	5.0 k
100 μs	10 M	10.0 k	10 M	10.0 k	10 M	10.0 k	10 M	10.0 k	10 M	10.0 k
200 μs	5 M	10.0 k	10 M	20.0 k	10 M	20.0 k	10 M	20.0 k	10 M	20.0 k
500 μs	2 M	10.0 k	5 M	25.0 k	10 M	50.0 k	10 M	50.0 k	10 M	50.0 k
1 ms	1 M	10.0 k	2 M	20.0 k	5 M	50.0 k	10 M	100.0 k	10 M	100.0 k
2 ms	500 k	10.0 k	1 M	20.0 k	2 M	40.0 k	5 M	100.0 k	10 M	200.0 k
5 ms	200 k	10.0 k	500 k	25.0 k	1 M	50.0 k	2 M	100.0 k	5 M	250.0 k
10 ms	100 k	10.0 k	200 k	20.0 k	500 k	50.0 k	1 M	100.0 k	2 M	200.0 k
20 ms	50 k	10.0 k	100 k	20.0 k	200 k	40.0 k	500 k	100.0 k	1 M	200.0 k
50 ms	20 k	10.0 k	50 k	25.0 k	100 k	50.0 k	200 k	100.0 k	500 k	250.0 k
100 ms	10 k	10.0 k	20 k	20.0 k	50 k	50.0 k	100 k	100.0 k	200 k	200.0 k
200 ms	5 k	10.0 k	10 k	20.0 k	20 k	40.0 k	50 k	100.0 k	100 k	200.0 k
500 ms	2 k	10.0 k	5 k	25.0 k	10 k	50.0 k	20 k	100.0 k	50 k	250.0 k
1 s	1 k	10.0 k	2 k	20.0 k	5 k	50.0 k	10 k	100.0 k	20 k	200.0 k
2 s	500	10.0 k	1 k	20.0 k	2 k	40.0 k	5 k	100.0 k	10 k	200.0 k
3 s	200	6.0 k	500	15.0 k	1 k	30.0 k	2 k	60.0 k	5 k	150.0 k
4 s	200	8.0 k	500	20.0 k	1 k	40.0 k	2 k	80.0 k	5 k	200.0 k
5 s	200	10.0 k	500	25.0 k	1 k	50.0 k	2 k	100.0 k	5 k	250.0 k
6 s	100	6.0 k	200	12.0 k	500	30.0 k	1 k	60.0 k	2 k	120.0 k
10 s	100	10.0 k	200	20.0 k	500	50.0 k	1 k	100.0 k	2 k	200.0 k
20 s	50	10.0 k	100	20.0 k	200	40.0 k	500	100.0 k	1 k	200.0 k
30 s	20	6.0 k	50	15.0 k	100	30.0 k	200	60.0 k	500	150.0 k
1 min	10	6.0 k	20	12.0 k	50	30.0 k	100	60.0 k	200	120.0 k
2 min	5	6.0 k	20	24.0 k	20	24.0 k	50	60.0 k	200	240.0 k
3 min	5	9.0 k	10	18.0 k	20	36.0 k	50	90.0 k	100	180.0 k
4 min	-	-	10	24.0 k	20	48.0 k	20	48.0 k	100	240.0 k
5 min	-	-	5	15.0 k	10	30.0 k	20	60.0 k	50	150.0 k
6 min	-	-	5	18.0 k	10	36.0 k	20	72.0 k	50	180.0 k
10 min	-	-	-	-	5	30.0 k	10	60.0 k	20	120.0 k
12 min	-	-	-	-	5	36.0 k	10	72.0 k	20	144.0 k
30 min	-	-	-	-	-	-	5	90.0 k	10	180.0 k

If Time/div is set to 1 hour or more, see [M-21] All Modules table.

The dual capture (high-speed sampling) setting range.

If the time scale is set to 100 ms/div or more in scope mode, roll mode display is used when the trigger mode is auto, auto level, single, or on-start.

Appendix 2 Relationship between the Time Scale, Sample Rate, and Record Length (Scope mode only)

[M-10]	SSD Recording	OFF (memory recording)
	Module's maximum sample rate	10 MS/s
	Set record length	500 k, 1 M, 2.5 M, 5 M, 10 Mpoint

Time/div	Set record length									
	500 kpoint		1 Mpoints		2.5 Mpoints		5 Mpoints		10 Mpoints	
	Sample Rate (S/s)	Display Record Length (Points)	Sample Rate (S/s)	Display Record Length (Points)	Sample Rate (S/s)	Display Record Length (Points)	Sample Rate (S/s)	Display Record Length (Points)	Sample Rate (S/s)	Display Record Length (Points)
1 μs	10 M	100	10 M	100	10 M	100	10 M	100	10 M	100
2 μs	10 M	200	10 M	200	10 M	200	10 M	200	10 M	200
5 μs	10 M	500	10 M	500	10 M	500	10 M	500	10 M	500
10 μs	10 M	1.0 k	10 M	1.0 k	10 M	1.0 k	10 M	1.0 k	10 M	1.0 k
20 μs	10 M	2.0 k	10 M	2.0 k	10 M	2.0 k	10 M	2.0 k	10 M	2.0 k
50 μs	10 M	5.0 k	10 M	5.0 k	10 M	5.0 k	10 M	5.0 k	10 M	5.0 k
100 μs	10 M	10.0 k	10 M	10.0 k	10 M	10.0 k	10 M	10.0 k	10 M	10.0 k
200 μs	10 M	20.0 k	10 M	20.0 k	10 M	20.0 k	10 M	20.0 k	10 M	20.0 k
500 μs	10 M	50.0 k	10 M	50.0 k	10 M	50.0 k	10 M	50.0 k	10 M	50.0 k
1 ms	10 M	100.0 k	10 M	100.0 k	10 M	100.0 k	10 M	100.0 k	10 M	100.0 k
2 ms	10 M	200.0 k	10 M	200.0 k	10 M	200.0 k	10 M	200.0 k	10 M	200.0 k
5 ms	10 M	500.0 k	10 M	500.0 k	10 M	500.0 k	10 M	500.0 k	10 M	500.0 k
10 ms	5 M	500.0 k	10 M	1.0 M	10 M	1.0 M	10 M	1.0 M	10 M	1.0 M
20 ms	2 M	400.0 k	5 M	1.0 M	10 M	2.0 M	10 M	2.0 M	10 M	2.0 M
50 ms	1 M	500.0 k	2 M	1.0 M	5 M	2.5 M	10 M	5.0 M	10 M	5.0 M
100 ms	500 k	500.0 k	1 M	1.0 M	2 M	2.0 M	5 M	5.0 M	10 M	10.0 M
200 ms	200 k	400.0 k	500 k	1.0 M	1 M	2.0 M	2 M	4.0 M	5 M	10.0 M
500 ms	100 k	500.0 k	200 k	1.0 M	500 k	2.5 M	1 M	5.0 M	2 M	10.0 M
1 s	50 k	500.0 k	100 k	1.0 M	200 k	2.0 M	500 k	5.0 M	1 M	10.0 M
2 s	20 k	400.0 k	50 k	1.0 M	100 k	2.0 M	200 k	4.0 M	500 k	10.0 M
3 s	10 k	300.0 k	20 k	600.0 k	50 k	1.5 M	100 k	3.0 M	200 k	6.0 M
4 s	10 k	400.0 k	20 k	800.0 k	50 k	2.0 M	100 k	4.0 M	200 k	8.0 M
5 s	10 k	500.0 k	20 k	1.0 M	50 k	2.5 M	100 k	5.0 M	200 k	10.0 M
6 s	5 k	300.0 k	10 k	600.0 k	20 k	1.2 M	50 k	3.0 M	100 k	6.0 M
10 s	5 k	500.0 k	10 k	1.0 M	20 k	2.0 M	50 k	5.0 M	100 k	10.0 M
20 s	2 k	400.0 k	5 k	1.0 M	10 k	2.0 M	20 k	4.0 M	50 k	10.0 M
30 s	1 k	300.0 k	2 k	600.0 k	5 k	1.5 M	10 k	3.0 M	20 k	6.0 M
1 min	500	300.0 k	1 k	600.0 k	2 k	1.2 M	5 k	3.0 M	10 k	6.0 M
2 min	200	240.0 k	500	600.0 k	2 k	2.4 M	2 k	2.4 M	5 k	6.0 M
3 min	200	360.0 k	500	900.0 k	1 k	1.8 M	2 k	3.6 M	5 k	9.0 M
4 min	200	480.0 k	200	480.0 k	1 k	2.4 M	2 k	4.8 M	2 k	4.8 M
5 min	100	300.0 k	200	600.0 k	500	1.5 M	1 k	3.0 M	2 k	6.0 M
6 min	100	360.0 k	200	720.0 k	500	1.8 M	1 k	3.6 M	2 k	7.2 M
10 min	50	300.0 k	100	600.0 k	200	1.2 M	500	3.0 M	1 k	6.0 M
12 min	50	360.0 k	100	720.0 k	200	1.4 M	500	3.6 M	1 k	7.2 M
30 min	20	360.0 k	50	900.0 k	100	1.8 M	200	3.6 M	500	9.0 M

If Time/div is set to 1 hour or more, see [M-22] All Modules table.

: The dual capture (high-speed sampling) setting range.

If the time scale is set to 100 ms/div or more in scope mode, roll mode display is used when the trigger mode is auto, auto level, single, or on-start.

Appendix 2 Relationship between the Time Scale, Sample Rate, and Record Length (Scope mode only)

[M-11]	SSD Recording	OFF (memory recording)
	Module's maximum sample rate	10 MS/s
	Set record length	25 M, 50 M, 100 M, 250 M, 500 Mpoint

Time/div	Set record length									
	25 Mpoints		50 Mpoints		100 Mpoints		250 Mpoints		500 Mpoints	
	Sample Rate (S/s)	Display Record Length (Points)	Sample Rate (S/s)	Display Record Length (Points)	Sample Rate (S/s)	Display Record Length (Points)	Sample Rate (S/s)	Display Record Length (Points)	Sample Rate (S/s)	Display Record Length (Points)
1 µs	10 M	100	10 M	100	10 M	100	10 M	100	10 M	100
2 µs	10 M	200	10 M	200	10 M	200	10 M	200	10 M	200
5 µs	10 M	500	10 M	500	10 M	500	10 M	500	10 M	500
10 µs	10 M	1.0 k	10 M	1.0 k	10 M	1.0 k	10 M	1.0 k	10 M	1.0 k
20 µs	10 M	2.0 k	10 M	2.0 k	10 M	2.0 k	10 M	2.0 k	10 M	2.0 k
50 µs	10 M	5.0 k	10 M	5.0 k	10 M	5.0 k	10 M	5.0 k	10 M	5.0 k
100 µs	10 M	10.0 k	10 M	10.0 k	10 M	10.0 k	10 M	10.0 k	10 M	10.0 k
200 µs	10 M	20.0 k	10 M	20.0 k	10 M	20.0 k	10 M	20.0 k	10 M	20.0 k
500 µs	10 M	50.0 k	10 M	50.0 k	10 M	50.0 k	10 M	50.0 k	10 M	50.0 k
1 ms	10 M	100.0 k	10 M	100.0 k	10 M	100.0 k	10 M	100.0 k	10 M	100.0 k
2 ms	10 M	200.0 k	10 M	200.0 k	10 M	200.0 k	10 M	200.0 k	10 M	200.0 k
5 ms	10 M	500.0 k	10 M	500.0 k	10 M	500.0 k	10 M	500.0 k	10 M	500.0 k
10 ms	10 M	1.0 M	10 M	1.0 M	10 M	1.0 M	10 M	1.0 M	10 M	1.0 M
20 ms	10 M	2.0 M	10 M	2.0 M	10 M	2.0 M	10 M	2.0 M	10 M	2.0 M
50 ms	10 M	5.0 M	10 M	5.0 M	10 M	5.0 M	10 M	5.0 M	10 M	5.0 M
100 ms	10 M	10.0 M	10 M	10.0 M	10 M	10.0 M	10 M	10.0 M	10 M	10.0 M
200 ms	10 M	20.0 M	10 M	20.0 M	10 M	20.0 M	10 M	20.0 M	10 M	20.0 M
500 ms	5 M	25.0 M	10 M	50.0 M	10 M	50.0 M	10 M	50.0 M	10 M	50.0 M
1 s	2 M	20.0 M	5 M	50.0 M	10 M	100.0 M	10 M	100.0 M	10 M	100.0 M
2 s	1 M	20.0 M	2 M	40.0 M	5 M	100.0 M	10 M	200.0 M	10 M	200.0 M
3 s	500 k	15.0 M	1 M	30.0 M	2 M	60.0 M	5 M	150.0 M	10 M	300.0 M
4 s	500 k	20.0 M	1 M	40.0 M	2 M	80.0 M	5 M	200.0 M	10 M	400.0 M
5 s	500 k	25.0 M	1 M	50.0 M	2 M	100.0 M	5 M	250.0 M	10 M	500.0 M
6 s	200 k	12.0 M	500 k	30.0 M	1 M	60.0 M	2 M	120.0 M	5 M	300.0 M
10 s	200 k	20.0 M	500 k	50.0 M	1 M	100.0 M	2 M	200.0 M	5 M	500.0 M
20 s	100 k	20.0 M	200 k	40.0 M	500 k	100.0 M	1 M	200.0 M	2 M	400.0 M
30 s	50 k	15.0 M	100 k	30.0 M	200 k	60.0 M	500 k	150.0 M	1 M	300.0 M
1 min	20 k	12.0 M	50 k	30.0 M	100 k	60.0 M	200 k	120.0 M	500 k	300.0 M
2 min	20 k	24.0 M	20 k	24.0 M	50 k	60.0 M	200 k	240.0 M	200 k	240.0 M
3 min	10 k	18.0 M	20 k	36.0 M	50 k	90.0 M	100 k	180.0 M	200 k	360.0 M
4 min	10 k	24.0 M	20 k	48.0 M	20 k	48.0 M	100 k	240.0 M	200 k	480.0 M
5 min	5 k	15.0 M	10 k	30.0 M	20 k	60.0 M	50 k	150.0 M	100 k	300.0 M
6 min	5 k	18.0 M	10 k	36.0 M	20 k	72.0 M	50 k	180.0 M	100 k	360.0 M
10 min	2 k	12.0 M	5 k	30.0 M	10 k	60.0 M	20 k	120.0 M	50 k	300.0 M
12 min	2 k	14.4 M	5 k	36.0 M	10 k	72.0 M	20 k	144.0 M	50 k	360.0 M
30 min	1 k	18.0 M	2 k	36.0 M	5 k	90.0 M	10 k	180.0 M	20 k	360.0 M

If Time/div is set to 1 hour or more, see [M-23] All Modules table.

: The dual capture (high-speed sampling) setting range.

If the time scale is set to 100 ms/div or more in scope mode, roll mode display is used when the trigger mode is auto, auto level, single, or on-start.

Appendix 2 Relationship between the Time Scale, Sample Rate, and Record Length (Scope mode only)

[M-12]	SSD Recording	OFF (memory recording)
	Module's maximum sample rate	10 MS/s
	Set record length	1 G, 2 G, 4 Gpoint

Time/div	Set record length					
	1 Gpoint		2 Gpoint		4 Gpoint	
	Sample Rate (S/s)	Display Record Length (Points)	Sample Rate (S/s)	Display Record Length (Points)	Sample Rate (S/s)	Display Record Length (Points)
1 μs	10 M	100	10 M	100	10 M	100
2 μs	10 M	200	10 M	200	10 M	200
5 μs	10 M	500	10 M	500	10 M	500
10 μs	10 M	1.0 k	10 M	1.0 k	10 M	1.0 k
20 μs	10 M	2.0 k	10 M	2.0 k	10 M	2.0 k
50 μs	10 M	5.0 k	10 M	5.0 k	10 M	5.0 k
100 μs	10 M	10.0 k	10 M	10.0 k	10 M	10.0 k
200 μs	10 M	20.0 k	10 M	20.0 k	10 M	20.0 k
500 μs	10 M	50.0 k	10 M	50.0 k	10 M	50.0 k
1 ms	10 M	100.0 k	10 M	100.0 k	10 M	100.0 k
2 ms	10 M	200.0 k	10 M	200.0 k	10 M	200.0 k
5 ms	10 M	500.0 k	10 M	500.0 k	10 M	500.0 k
10 ms	10 M	1.0 M	10 M	1.0 M	10 M	1.0 M
20 ms	10 M	2.0 M	10 M	2.0 M	10 M	2.0 M
50 ms	10 M	5.0 M	10 M	5.0 M	10 M	5.0 M
100 ms	10 M	10.0 M	10 M	10.0 M	10 M	10.0 M
200 ms	10 M	20.0 M	10 M	20.0 M	10 M	20.0 M
500 ms	10 M	50.0 M	10 M	50.0 M	10 M	50.0 M
1 s	10 M	100.0 M	10 M	100.0 M	10 M	100.0 M
2 s	10 M	200.0 M	10 M	200.0 M	10 M	200.0 M
3 s	10 M	300.0 M	10 M	300.0 M	10 M	300.0 M
4 s	10 M	400.0 M	10 M	400.0 M	10 M	400.0 M
5 s	10 M	500.0 M	10 M	500.0 M	10 M	500.0 M
6 s	10 M	600.0 M	10 M	600.0 M	10 M	600.0 M
10 s	10 M	1.0 G	10 M	1.0 G	10 M	1.0 G
20 s	5 M	1.0 G	10 M	2.0 G	10 M	2.0 G
30 s	2 M	600.0 M	5 M	1.5 G	10 M	3.0 G
1 min	1 M	600.0 M	2 M	1.5 G	5 M	3.0 G
2 min	500 k	600.0 M	1 M	1.2 G	2 M	2.4 G
3 min	500 k	900.0 M	1 M	1.8 G	2 M	3.6 G
4 min	200 k	480.0 M	500 k	1.2 G	1 M	2.4 G
5 min	200 k	600.0 M	500 k	1.5 G	1 M	3 G
6 min	200 k	720.0 M	500 k	1.8 G	1 M	3.6 G
10 min	100 k	600.0 M	200 k	1.2 G	500 k	3 G
12 min	100 k	720.0 M	200 k	1.44 G	500 k	3.6 G
30 min	50 k	900.0 M	100 k	1.8 G	200 k	3.6 G

If Time/div is set to 1 hour or more, see [M-24] All Modules table.

If the time scale is set to 100 ms/div or more in scope mode, roll mode display is used when the trigger mode is auto, auto level, single, or on-start.

Module's Maximum Sample Rate: 1 MS/s

[M-13]	SSD Recording	OFF (memory recording)
	Module's maximum sample rate	1 MS/s
	Set record length	10 k, 25 k, 50 k, 100 k, 250 kpoint

Time/div	Set record length									
	10 kpoint		25 kpoint		50 kpoint		100 kpoint		250 kpoint	
	Sample Rate (S/s)	Display Record Length (Points)	Sample Rate (S/s)	Display Record Length (Points)	Sample Rate (S/s)	Display Record Length (Points)	Sample Rate (S/s)	Display Record Length (Points)	Sample Rate (S/s)	Display Record Length (Points)
10 μs	1 M	100	1 M	100	1 M	100	1 M	100	1 M	100
20 μs	1 M	200	1 M	200	1 M	200	1 M	200	1 M	200
50 μs	1 M	500	1 M	500	1 M	500	1 M	500	1 M	500
100 μs	1 M	1.0 k	1 M	1.0 k	1 M	1.0 k	1 M	1.0 k	1 M	1.0 k
200 μs	1 M	2.0 k	1 M	2.0 k	1 M	2.0 k	1 M	2.0 k	1 M	2.0 k
500 μs	1 M	5.0 k	1 M	5.0 k	1 M	5.0 k	1 M	5.0 k	1 M	5.0 k
1 ms	1 M	10.0 k	1 M	10.0 k	1 M	10.0 k	1 M	10.0 k	1 M	10.0 k
2 ms	500 k	10.0 k	1 M	20.0 k	1 M	20.0 k	1 M	20.0 k	1 M	20.0 k
5 ms	200 k	10.0 k	500 k	25.0 k	1 M	50.0 k	1 M	50.0 k	1 M	50.0 k
10 ms	100 k	10.0 k	200 k	20.0 k	500 k	50.0 k	1 M	100.0 k	1 M	100.0 k
20 ms	50 k	10.0 k	100 k	20.0 k	200 k	40.0 k	500 k	100.0 k	1 M	200.0 k
50 ms	20 k	10.0 k	50 k	25.0 k	100 k	50.0 k	200 k	100.0 k	500 k	250.0 k
100 ms	10 k	10.0 k	20 k	20.0 k	50 k	50.0 k	100 k	100.0 k	200 k	200.0 k
200 ms	5 k	10.0 k	10 k	20.0 k	20 k	40.0 k	50 k	100.0 k	100 k	200.0 k
500 ms	2 k	10.0 k	5 k	25.0 k	10 k	50.0 k	20 k	100.0 k	50 k	250.0 k
1 s	1 k	10.0 k	2 k	20.0 k	5 k	50.0 k	10 k	100.0 k	20 k	200.0 k
2 s	500	10.0 k	1 k	20.0 k	2 k	40.0 k	5 k	100.0 k	10 k	200.0 k
3 s	200	6.0 k	500	15.0 k	1 k	30.0 k	2 k	60.0 k	5 k	150.0 k
4 s	200	8.0 k	500	20.0 k	1 k	40.0 k	2 k	80.0 k	5 k	200.0 k
5 s	200	10.0 k	500	25.0 k	1 k	50.0 k	2 k	100.0 k	5 k	250.0 k
6 s	100	6.0 k	200	12.0 k	500	30.0 k	1 k	60.0 k	2 k	120.0 k
10 s	100	10.0 k	200	20.0 k	500	50.0 k	1 k	100.0 k	2 k	200.0 k
20 s	50	10.0 k	100	20.0 k	200	40.0 k	500	100.0 k	1 k	200.0 k
30 s	20	6.0 k	50	15.0 k	100	30.0 k	200	60.0 k	500	150.0 k
1 min	10	6.0 k	20	12.0 k	50	30.0 k	100	60.0 k	200	120.0 k
2 min	5	6.0 k	20	24.0 k	20	24.0 k	50	60.0 k	200	240.0 k
3 min	5	9.0 k	10	18.0 k	20	36.0 k	50	90.0 k	100	180.0 k
4 min	-	-	10	24.0 k	20	48.0 k	20	48.0 k	100	240.0 k
5 min	-	-	5	15.0 k	10	30.0 k	20	60.0 k	50	150.0 k
6 min	-	-	5	18.0 k	10	36.0 k	20	72.0 k	50	180.0 k
10 min	-	-	-	-	5	30.0 k	10	60.0 k	20	120.0 k
12 min	-	-	-	-	5	36.0 k	10	72.0 k	20	144.0 k
30 min	-	-	-	-	-	-	5	90.0 k	10	180.0 k

If Time/div is set to 1 hour or more, see [M-21] All Modules table.

: The dual capture (high-speed sampling) setting range.

If the time scale is set to 100 ms/div or more in scope mode, roll mode display is used when the trigger mode is auto, auto level, single, or on-start.

Appendix 2 Relationship between the Time Scale, Sample Rate, and Record Length (Scope mode only)

[M-14]	SSD Recording	OFF (memory recording)
	Module's maximum sample rate	1 MS/s
	Set record length	500 k, 1 M, 2.5 M, 5 M, 10 Mpoint

Time/div	Set record length									
	500 kpoint		1 Mpoints		2.5 Mpoints		5 Mpoints		10 Mpoints	
	Sample Rate (S/s)	Display Record Length (Points)	Sample Rate (S/s)	Display Record Length (Points)	Sample Rate (S/s)	Display Record Length (Points)	Sample Rate (S/s)	Display Record Length (Points)	Sample Rate (S/s)	Display Record Length (Points)
10 µs	1 M	100	1 M	100	1 M	100	1 M	100	1 M	100
20 µs	1 M	200	1 M	200	1 M	200	1 M	200	1 M	200
50 µs	1 M	500	1 M	500	1 M	500	1 M	500	1 M	500
100 µs	1 M	1.0 k	1 M	1.0 k	1 M	1.0 k	1 M	1.0 k	1 M	1.0 k
200 µs	1 M	2.0 k	1 M	2.0 k	1 M	2.0 k	1 M	2.0 k	1 M	2.0 k
500 µs	1 M	5.0 k	1 M	5.0 k	1 M	5.0 k	1 M	5.0 k	1 M	5.0 k
1 ms	1 M	10.0 k	1 M	10.0 k	1 M	10.0 k	1 M	10.0 k	1 M	10.0 k
2 ms	1 M	20.0 k	1 M	20.0 k	1 M	20.0 k	1 M	20.0 k	1 M	20.0 k
5 ms	1 M	50.0 k	1 M	50.0 k	1 M	50.0 k	1 M	50.0 k	1 M	50.0 k
10 ms	1 M	100.0 k	1 M	100.0 k	1 M	100.0 k	1 M	100.0 k	1 M	100.0 k
20 ms	1 M	200.0 k	1 M	200.0 k	1 M	200.0 k	1 M	200.0 k	1 M	200.0 k
50 ms	1 M	500.0 k	1 M	500.0 k	1 M	500.0 k	1 M	500.0 k	1 M	500.0 k
100 ms	500 k	500.0 k	1 M	1.0 M	1 M	1.0 M	1 M	1.0 M	1 M	1.0 M
200 ms	200 k	400.0 k	500 k	1.0 M	1 M	2.0 M	1 M	2.0 M	1 M	2.0 M
500 ms	100 k	500.0 k	200 k	1.0 M	500 k	2.5 M	1 M	5.0 M	1 M	5.0 M
1 s	50 k	500.0 k	100 k	1.0 M	200 k	2.0 M	500 k	5.0 M	1 M	10.0 M
2 s	20 k	400.0 k	50 k	1.0 M	100 k	2.0 M	200 k	4.0 M	500 k	10.0 M
3 s	10 k	300.0 k	20 k	600.0 k	50 k	1.5 M	100 k	3.0 M	200 k	6.0 M
4 s	10 k	400.0 k	20 k	800.0 k	50 k	2.0 M	100 k	4.0 M	200 k	8.0 M
5 s	10 k	500.0 k	20 k	1.0 M	50 k	2.5 M	100 k	5.0 M	200 k	10.0 M
6 s	5 k	300.0 k	10 k	600.0 k	20 k	1.2 M	50 k	3.0 M	100 k	6.0 M
10 s	5 k	500.0 k	10 k	1.0 M	20 k	2.0 M	50 k	5.0 M	100 k	10.0 M
20 s	2 k	400.0 k	5 k	1.0 M	10 k	2.0 M	20 k	4.0 M	50 k	10.0 M
30 s	1 k	300.0 k	2 k	600.0 k	5 k	1.5 M	10 k	3.0 M	20 k	6.0 M
1 min	500	300.0 k	1 k	600.0 k	2 k	1.2 M	5 k	3.0 M	10 k	6.0 M
2 min	200	240.0 k	500	600.0 k	2 k	2.4 M	2 k	2.4 M	5 k	6.0 M
3 min	200	360.0 k	500	900.0 k	1 k	1.8 M	2 k	3.6 M	5 k	9.0 M
4 min	200	480.0 k	200	480.0 k	1 k	2.4 M	2 k	4.8 M	2 k	4.8 M
5 min	100	300.0 k	200	600.0 k	500	1.5 M	1 k	3.0 M	2 k	6.0 M
6 min	100	360.0 k	200	720.0 k	500	1.8 M	1 k	3.6 M	2 k	7.2 M
10 min	50	300.0 k	100	600.0 k	200	1.2 M	500	3.0 M	1 k	6.0 M
12 min	50	360.0 k	100	720.0 k	200	1.4 M	500	3.6 M	1 k	7.2 M
30 min	20	360.0 k	50	900.0 k	100	1.8 M	200	3.6 M	500	9.0 M

If Time/div is set to 1 hour or more, see [M-22] All Modules table.

: The dual capture (high-speed sampling) setting range.

If the time scale is set to 100 ms/div or more in scope mode, roll mode display is used when the trigger mode is auto, auto level, single, or on-start.

Appendix 2 Relationship between the Time Scale, Sample Rate, and Record Length (Scope mode only)

[M-15]	SSD Recording	OFF (memory recording)
	Module's maximum sample rate	1 MS/s
	Set record length	25 M, 50 M, 100 M, 250 M, 500 Mpoint

Time/div	Set record length									
	25 Mpoints		50 Mpoints		100 Mpoints		250 Mpoints		500 Mpoints	
	Sample Rate (S/s)	Display Record Length (Points)	Sample Rate (S/s)	Display Record Length (Points)	Sample Rate (S/s)	Display Record Length (Points)	Sample Rate (S/s)	Display Record Length (Points)	Sample Rate (S/s)	Display Record Length (Points)
10 μs	1 M	100	1 M	100	1 M	100	1 M	100	1 M	100
20 μs	1 M	200	1 M	200	1 M	200	1 M	200	1 M	200
50 μs	1 M	500	1 M	500	1 M	500	1 M	500	1 M	500
100 μs	1 M	1.0 k	1 M	1.0 k	1 M	1.0 k	1 M	1.0 k	1 M	1.0 k
200 μs	1 M	2.0 k	1 M	2.0 k	1 M	2.0 k	1 M	2.0 k	1 M	2.0 k
500 μs	1 M	5.0 k	1 M	5.0 k	1 M	5.0 k	1 M	5.0 k	1 M	5.0 k
1 ms	1 M	10.0 k	1 M	10.0 k	1 M	10.0 k	1 M	10.0 k	1 M	10.0 k
2 ms	1 M	20.0 k	1 M	20.0 k	1 M	20.0 k	1 M	20.0 k	1 M	20.0 k
5 ms	1 M	50.0 k	1 M	50.0 k	1 M	50.0 k	1 M	50.0 k	1 M	50.0 k
10 ms	1 M	100.0 k	1 M	100.0 k	1 M	100.0 k	1 M	100.0 k	1 M	100.0 k
20 ms	1 M	200.0 k	1 M	200.0 k	1 M	200.0 k	1 M	200.0 k	1 M	200.0 k
50 ms	1 M	500.0 k	1 M	500.0 k	1 M	500.0 k	1 M	500.0 k	1 M	500.0 k
100 ms	1 M	1.0 M	1 M	1.0 M	1 M	1.0 M	1 M	1.0 M	1 M	1.0 M
200 ms	1 M	2.0 M	1 M	2.0 M	1 M	2.0 M	1 M	2.0 M	1 M	2.0 M
500 ms	1 M	5.0 M	1 M	5.0 M	1 M	5.0 M	1 M	5.0 M	1 M	5.0 M
1 s	1 M	10.0 M	1 M	10.0 M	1 M	10.0 M	1 M	10.0 M	1 M	10.0 M
2 s	1 M	20.0 M	1 M	20.0 M	1 M	20.0 M	1 M	20.0 M	1 M	20.0 M
3 s	500 k	15.0 M	1 M	30.0 M	1 M	30.0 M	1 M	30.0 M	1 M	30.0 M
4 s	500 k	20.0 M	1 M	40.0 M	1 M	40.0 M	1 M	40.0 M	1 M	40.0 M
5 s	500 k	25.0 M	1 M	50.0 M	1 M	50.0 M	1 M	50.0 M	1 M	50.0 M
6 s	200 k	12.0 M	500 k	30.0 M	1 M	60.0 M	1 M	60.0 M	1 M	60.0 M
10 s	200 k	20.0 M	500 k	50.0 M	1 M	100.0 M	1 M	100.0 M	1 M	100.0 M
20 s	100 k	20.0 M	200 k	40.0 M	500 k	100.0 M	1 M	200.0 M	1 M	200.0 M
30 s	50 k	15.0 M	100 k	30.0 M	200 k	60.0 M	500 k	150.0 M	1 M	300.0 M
1 min	20 k	12.0 M	50 k	30.0 M	100 k	60.0 M	200 k	120.0 M	500 k	300.0 M
2 min	20 k	24.0 M	20 k	24.0 M	50 k	60.0 M	200 k	240.0 M	200 k	240.0 M
3 min	10 k	18.0 M	20 k	36.0 M	50 k	90.0 M	100 k	180.0 M	200 k	360.0 M
4 min	10 k	24.0 M	20 k	48.0 M	20 k	48.0 M	100 k	240.0 M	200 k	480.0 M
5 min	5 k	15.0 M	10 k	30.0 M	20 k	60.0 M	50 k	150.0 M	100 k	300.0 M
6 min	5 k	18.0 M	10 k	36.0 M	20 k	72.0 M	50 k	180.0 M	100 k	360.0 M
10 min	2 k	12.0 M	5 k	30.0 M	10 k	60.0 M	20 k	120.0 M	50 k	300.0 M
12 min	2 k	14.4 M	5 k	36.0 M	10 k	72.0 M	20 k	144.0 M	50 k	360.0 M
30 min	1 k	18.0 M	2 k	36.0 M	5 k	90.0 M	10 k	180.0 M	20 k	360.0 M

If Time/div is set to 1 hour or more, see [M-23] All Modules table.

: The dual capture (high-speed sampling) setting range.

If the time scale is set to 100 ms/div or more in scope mode, roll mode display is used when the trigger mode is auto, auto level, single, or on-start.

Appendix 2 Relationship between the Time Scale, Sample Rate, and Record Length (Scope mode only)

[M-16]	SSD Recording	OFF (memory recording)
	Module's maximum sample rate	1 MS/s
	Set record length	1 G, 2 G, 4 Gpoint

Time/div	Set record length					
	1 Gpoint		2 Gpoint		4 Gpoint	
	Sample Rate (S/s)	Display Record Length (Points)	Sample Rate (S/s)	Display Record Length (Points)	Sample Rate (S/s)	Display Record Length (Points)
10 µs	1 M	100	1 M	100	1 M	100
20 µs	1 M	200	1 M	200	1 M	200
50 µs	1 M	500	1 M	500	1 M	500
100 µs	1 M	1.0 k	1 M	1.0 k	1 M	1.0 k
200 µs	1 M	2.0 k	1 M	2.0 k	1 M	2.0 k
500 µs	1 M	5.0 k	1 M	5.0 k	1 M	5.0 k
1 ms	1 M	10.0 k	1 M	10.0 k	1 M	10.0 k
2 ms	1 M	20.0 k	1 M	20.0 k	1 M	20.0 k
5 ms	1 M	50.0 k	1 M	50.0 k	1 M	50.0 k
10 ms	1 M	100.0 k	1 M	100.0 k	1 M	100.0 k
20 ms	1 M	200.0 k	1 M	200.0 k	1 M	200.0 k
50 ms	1 M	500.0 k	1 M	500.0 k	1 M	500.0 k
100 ms	1 M	1.0 M	1 M	1.0 M	1 M	1.0 M
200 ms	1 M	2.0 M	1 M	2.0 M	1 M	2.0 M
500 ms	1 M	5.0 M	1 M	5.0 M	1 M	5.0 M
1 s	1 M	10.0 M	1 M	10.0 M	1 M	10.0 M
2 s	1 M	20.0 M	1 M	20.0 M	1 M	20.0 M
3 s	1 M	30.0 M	1 M	30.0 M	1 M	30.0 M
4 s	1 M	40.0 M	1 M	40.0 M	1 M	40.0 M
5 s	1 M	50.0 M	1 M	50.0 M	1 M	50.0 M
6 s	1 M	60.0 M	1 M	60.0 M	1 M	60.0 M
10 s	1 M	100.0 M	1 M	100.0 M	1 M	100.0 M
20 s	1 M	200.0 M	1 M	200.0 M	1 M	200.0 M
30 s	1 M	300.0 M	1 M	300.0 M	1 M	300.0 M
1 min	1 M	600.0 M	1 M	600.0 M	1 M	600.0 M
2 min	500 k	600.0 M	1 M	1.2 G	1 M	1.2 G
3 min	500 k	900.0 M	1 M	1.8 G	1 M	1.8 G
4 min	200 k	480.0 M	500 k	1.2 G	1 M	2.4 G
5 min	200 k	600.0 M	500 k	1.5 G	1 M	3 G
6 min	200 k	720.0 M	500 k	1.8 G	1 M	3.6 G
10 min	100 k	600.0 M	200 k	1.2 G	500 k	3 G
12 min	100 k	720.0 M	200 k	1.44 G	500 k	3.6 G
30 min	50 k	900.0 M	100 k	1.8 G	200 k	3.6 G

If Time/div is set to 1 hour or more, see [M-24] All Modules table.

If the time scale is set to 100 ms/div or more in scope mode, roll mode display is used when the trigger mode is auto, auto level, single, or on-start.

Module's Maximum Sample Rate: 100 kS/s

[M-17]	SSD Recording	OFF (memory recording)
	Module's maximum sample rate	100 kS/s
	Set record length	10 k, 25 k, 50 k, 100 k, 250 kpoint

Time/div	Set record length									
	10 kpoint		25 kpoint		50 kpoint		100 kpoint		250 kpoint	
	Sample Rate (S/s)	Display Record Length (Points)	Sample Rate (S/s)	Display Record Length (Points)	Sample Rate (S/s)	Display Record Length (Points)	Sample Rate (S/s)	Display Record Length (Points)	Sample Rate (S/s)	Display Record Length (Points)
100 µs	100 k	100	100 k	100	100 k	100	100 k	100	100 k	100
200 µs	100 k	200	100 k	200	100 k	200	100 k	200	100 k	200
500 µs	100 k	500	100 k	500	100 k	500	100 k	500	100 k	500
1 ms	100 k	1.0 k	100 k	1.0 k	100 k	1.0 k	100 k	1.0 k	100 k	1.0 k
2 ms	100 k	2.0 k	100 k	2.0 k	100 k	2.0 k	100 k	2.0 k	100 k	2.0 k
5 ms	100 k	5.0 k	100 k	5.0 k	100 k	5.0 k	100 k	5.0 k	100 k	5.0 k
10 ms	100 k	10.0 k	100 k	10.0 k	100 k	10.0 k	100 k	10.0 k	100 k	10.0 k
20 ms	50 k	10.0 k	100 k	20.0 k	100 k	20.0 k	100 k	20.0 k	100 k	20.0 k
50 ms	20 k	10.0 k	50 k	25.0 k	100 k	50.0 k	100 k	50.0 k	100 k	50.0 k
100 ms	10 k	10.0 k	20 k	20.0 k	50 k	50.0 k	100 k	100.0 k	100 k	100.0 k
200 ms	5 k	10.0 k	10 k	20.0 k	20 k	40.0 k	50 k	100.0 k	100 k	200.0 k
500 ms	2 k	10.0 k	5 k	25.0 k	10 k	50.0 k	20 k	100.0 k	50 k	250.0 k
1 s	1 k	10.0 k	2 k	20.0 k	5 k	50.0 k	10 k	100.0 k	20 k	200.0 k
2 s	500	10.0 k	1 k	20.0 k	2 k	40.0 k	5 k	100.0 k	10 k	200.0 k
3 s	200	6.0 k	500	15.0 k	1 k	30.0 k	2 k	60.0 k	5 k	150.0 k
4 s	200	8.0 k	500	20.0 k	1 k	40.0 k	2 k	80.0 k	5 k	200.0 k
5 s	200	10.0 k	500	25.0 k	1 k	50.0 k	2 k	100.0 k	5 k	250.0 k
6 s	100	6.0 k	200	12.0 k	500	30.0 k	1 k	60.0 k	2 k	120.0 k
10 s	100	10.0 k	200	20.0 k	500	50.0 k	1 k	100.0 k	2 k	200.0 k
20 s	50	10.0 k	100	20.0 k	200	40.0 k	500	100.0 k	1 k	200.0 k
30 s	20	6.0 k	50	15.0 k	100	30.0 k	200	60.0 k	500	150.0 k
1 min	10	6.0 k	20	12.0 k	50	30.0 k	100	60.0 k	200	120.0 k
2 min	5	6.0 k	20	24.0 k	20	24.0 k	50	60.0 k	200	240.0 k
3 min	5	9.0 k	10	18.0 k	20	36.0 k	50	90.0 k	100	180.0 k
4 min	-	-	10	24.0 k	20	48.0 k	20	48.0 k	100	240.0 k
5 min	-	-	5	15.0 k	10	30.0 k	20	60.0 k	50	150.0 k
6 min	-	-	5	18.0 k	10	36.0 k	20	72.0 k	50	180.0 k
10 min	-	-	-	-	5	30.0 k	10	60.0 k	20	120.0 k
12 min	-	-	-	-	5	36.0 k	10	72.0 k	20	144.0 k
30 min	-	-	-	-	-	-	5	90.0 k	10	180.0 k

If Time/div is set to 1 hour or more, see [M-21] All Modules table.

■: The dual capture (high-speed sampling) setting range.

If the time scale is set to 100 ms/div or more in scope mode, roll mode display is used when the trigger mode is auto, auto level, single, or on-start.

Appendix 2 Relationship between the Time Scale, Sample Rate, and Record Length (Scope mode only)

[M-18]	SSD Recording	OFF (memory recording)
	Module's maximum sample rate	100 kS/s
	Set record length	500 k, 1 M, 2.5 M, 5 M, 10 Mpoint

Time/div	Set record length									
	500 kpoint		1 Mpoints		2.5 Mpoints		5 Mpoints		10 Mpoints	
	Sample Rate (S/s)	Display Record Length (Points)	Sample Rate (S/s)	Display Record Length (Points)	Sample Rate (S/s)	Display Record Length (Points)	Sample Rate (S/s)	Display Record Length (Points)	Sample Rate (S/s)	Display Record Length (Points)
100 µs	100 k	100	100 k	100	100 k	100	100 k	100	100 k	100
200 µs	100 k	200	100 k	200	100 k	200	100 k	200	100 k	200
500 µs	100 k	500	100 k	500	100 k	500	100 k	500	100 k	500
1 ms	100 k	1.0 k	100 k	1.0 k	100 k	1.0 k	100 k	1.0 k	100 k	1.0 k
2 ms	100 k	2.0 k	100 k	2.0 k	100 k	2.0 k	100 k	2.0 k	100 k	2.0 k
5 ms	100 k	5.0 k	100 k	5.0 k	100 k	5.0 k	100 k	5.0 k	100 k	5.0 k
10 ms	100 k	10.0 k	100 k	10.0 k	100 k	10.0 k	100 k	10.0 k	100 k	10.0 k
20 ms	100 k	20.0 k	100 k	20.0 k	100 k	20.0 k	100 k	20.0 k	100 k	20.0 k
50 ms	100 k	50.0 k	100 k	50.0 k	100 k	50.0 k	100 k	50.0 k	100 k	50.0 k
100 ms	100 k	100.0 k	100 k	100.0 k	100 k	100.0 k	100 k	100.0 k	100 k	100.0 k
200 ms	100 k	200.0 k	100 k	200.0 k	100 k	200.0 k	100 k	200.0 k	100 k	200.0 k
500 ms	100 k	500.0 k	100 k	500.0 k	100 k	500.0 k	100 k	500.0 k	100 k	500.0 k
1 s	50 k	500.0 k	100 k	1.0 M	100 k	1.0 M	100 k	1.0 M	100 k	1.0 M
2 s	20 k	400.0 k	50 k	1.0 M	100 k	2.0 M	100 k	2.0 M	100 k	2.0 M
3 s	10 k	300.0 k	20 k	600.0 k	50 k	1.5 M	100 k	3.0 M	100 k	3.0 M
4 s	10 k	400.0 k	20 k	800.0 k	50 k	2.0 M	100 k	4.0 M	100 k	4.0 M
5 s	10 k	500.0 k	20 k	1.0 M	50 k	2.5 M	100 k	5.0 M	100 k	5.0 M
6 s	5 k	300.0 k	10 k	600.0 k	20 k	1.2 M	50 k	3.0 M	100 k	6.0 M
10 s	5 k	500.0 k	10 k	1.0 M	20 k	2.0 M	50 k	5.0 M	100 k	10.0 M
20 s	2 k	400.0 k	5 k	1.0 M	10 k	2.0 M	20 k	4.0 M	50 k	10.0 M
30 s	1 k	300.0 k	2 k	600.0 k	5 k	1.5 M	10 k	3.0 M	20 k	6.0 M
1 min	500	300.0 k	1 k	600.0 k	2 k	1.2 M	5 k	3.0 M	10 k	6.0 M
2 min	200	240.0 k	500	600.0 k	2 k	2.4 M	2 k	2.4 M	5 k	6.0 M
3 min	200	360.0 k	500	900.0 k	1 k	1.8 M	2 k	3.6 M	5 k	9.0 M
4 min	200	480.0 k	200	480.0 k	1 k	2.4 M	2 k	4.8 M	2 k	4.8 M
5 min	100	300.0 k	200	600.0 k	500	1.5 M	1 k	3.0 M	2 k	6.0 M
6 min	100	360.0 k	200	720.0 k	500	1.8 M	1 k	3.6 M	2 k	7.2 M
10 min	50	300.0 k	100	600.0 k	200	1.2 M	500	3.0 M	1 k	6.0 M
12 min	50	360.0 k	100	720.0 k	200	1.4 M	500	3.6 M	1 k	7.2 M
30 min	20	360.0 k	50	900.0 k	100	1.8 M	200	3.6 M	500	9.0 M

If Time/div is set to 1 hour or more, see [M-22] All Modules table.

■: The dual capture (high-speed sampling) setting range.

□: The dual capture (low-speed side) setting range.

If the time scale is set to 100 ms/div or more in scope mode, roll mode display is used when the trigger mode is auto, auto level, single, or on-start.

Appendix 2 Relationship between the Time Scale, Sample Rate, and Record Length (Scope mode only)

[M-19]	SSD Recording	OFF (memory recording)
	Module's maximum sample rate	100 kS/s
	Set record length	25 M, 50 M, 100 M, 250 M, 500 Mpoint

Time/div	Set record length									
	25 Mpoints		50 Mpoints		100 Mpoints		250 Mpoints		500 Mpoints	
	Sample Rate (S/s)	Display Record Length (Points)	Sample Rate (S/s)	Display Record Length (Points)	Sample Rate (S/s)	Display Record Length (Points)	Sample Rate (S/s)	Display Record Length (Points)	Sample Rate (S/s)	Display Record Length (Points)
100 µs	100 k	100	100 k	100	100 k	100	100 k	100	100 k	100
200 µs	100 k	200	100 k	200	100 k	200	100 k	200	100 k	200
500 µs	100 k	500	100 k	500	100 k	500	100 k	500	100 k	500
1 ms	100 k	1.0 k	100 k	1.0 k	100 k	1.0 k	100 k	1.0 k	100 k	1.0 k
2 ms	100 k	2.0 k	100 k	2.0 k	100 k	2.0 k	100 k	2.0 k	100 k	2.0 k
5 ms	100 k	5.0 k	100 k	5.0 k	100 k	5.0 k	100 k	5.0 k	100 k	5.0 k
10 ms	100 k	10.0 k	100 k	10.0 k	100 k	10.0 k	100 k	10.0 k	100 k	10.0 k
20 ms	100 k	20.0 k	100 k	20.0 k	100 k	20.0 k	100 k	20.0 k	100 k	20.0 k
50 ms	100 k	50.0 k	100 k	50.0 k	100 k	50.0 k	100 k	50.0 k	100 k	50.0 k
100 ms	100 k	100.0 k	100 k	100.0 k	100 k	100.0 k	100 k	100.0 k	100 k	100.0 k
200 ms	100 k	200.0 k	100 k	200.0 k	100 k	200.0 k	100 k	200.0 k	100 k	200.0 k
500 ms	100 k	500.0 k	100 k	500.0 k	100 k	500.0 k	100 k	500.0 k	100 k	500.0 k
1 s	100 k	1.0 M	100 k	1.0 M	100 k	1.0 M	100 k	1.0 M	100 k	1.0 M
2 s	100 k	2.0 M	100 k	2.0 M	100 k	2.0 M	100 k	2.0 M	100 k	2.0 M
3 s	100 k	3.0 M	100 k	3.0 M	100 k	3.0 M	100 k	3.0 M	100 k	3.0 M
4 s	100 k	4.0 M	100 k	4.0 M	100 k	4.0 M	100 k	4.0 M	100 k	4.0 M
5 s	100 k	5.0 M	100 k	5.0 M	100 k	5.0 M	100 k	5.0 M	100 k	5.0 M
6 s	100 k	6.0 M	100 k	6.0 M	100 k	6.0 M	100 k	6.0 M	100 k	6.0 M
10 s	100 k	10.0 M	100 k	10.0 M	100 k	10.0 M	100 k	10.0 M	100 k	10.0 M
20 s	100 k	20.0 M	100 k	20.0 M	100 k	20.0 M	100 k	20.0 M	100 k	20.0 M
30 s	50 k	15.0 M	100 k	30.0 M	100 k	30.0 M	100 k	30.0 M	100 k	30.0 M
1 min	20 k	12.0 M	50 k	30.0 M	100 k	60.0 M	100 k	60.0 M	100 k	60.0 M
2 min	20 k	24.0 M	20 k	24.0 M	50 k	60.0 M	100 k	120.0 M	100 k	120.0 M
3 min	10 k	18.0 M	20 k	36.0 M	50 k	90.0 M	100 k	180.0 M	100 k	180.0 M
4 min	10 k	24.0 M	20 k	48.0 M	20 k	48.0 M	100 k	240.0 M	100 k	240.0 M
5 min	5 k	15.0 M	10 k	30.0 M	20 k	60.0 M	50 k	150.0 M	100 k	300.0 M
6 min	5 k	18.0 M	10 k	36.0 M	20 k	72.0 M	50 k	180.0 M	100 k	360.0 M
10 min	2 k	12.0 M	5 k	30.0 M	10 k	60.0 M	20 k	120.0 M	50 k	300.0 M
12 min	2 k	14.4 M	5 k	36.0 M	10 k	72.0 M	20 k	144.0 M	50 k	360.0 M
30 min	1 k	18.0 M	2 k	36.0 M	5 k	90.0 M	10 k	180.0 M	20 k	360.0 M

If Time/div is set to 1 hour or more, see [M-23] All Modules table.

- : The dual capture (high-speed sampling) setting range.
- : The dual capture (low-speed side) setting range.
- : This is referenced in "Examples of Using the Appendix" on page App-1.

If the time scale is set to 100 ms/div or more in scope mode, roll mode display is used when the trigger mode is auto, auto level, single, or on-start.

Appendix 2 Relationship between the Time Scale, Sample Rate, and Record Length (Scope mode only)

[M-20]	SSD Recording	OFF (memory recording)
	Module's maximum sample rate	100 kS/s
	Set record length	1 G, 2 G, 4 Gpoint

Time/div	Set record length					
	1 Gpoint		2 Gpoint		4 Gpoint	
	Sample Rate (S/s)	Display Record Length (Points)	Sample Rate (S/s)	Display Record Length (Points)	Sample Rate (S/s)	Display Record Length (Points)
100 μ s	100 k	100	100 k	100	100 k	100
200 μ s	100 k	200	100 k	200	100 k	200
500 μ s	100 k	500	100 k	500	100 k	500
1 ms	100 k	1.0 k	100 k	1.0 k	100 k	1.0 k
2 ms	100 k	2.0 k	100 k	2.0 k	100 k	2.0 k
5 ms	100 k	5.0 k	100 k	5.0 k	100 k	5.0 k
10 ms	100 k	10.0 k	100 k	10.0 k	100 k	10.0 k
20 ms	100 k	20.0 k	100 k	20.0 k	100 k	20.0 k
50 ms	100 k	50.0 k	100 k	50.0 k	100 k	50.0 k
100 ms	100 k	100.0 k	100 k	100.0 k	100 k	100.0 k
200 ms	100 k	200.0 k	100 k	200.0 k	100 k	200.0 k
500 ms	100 k	500.0 k	100 k	500.0 k	100 k	500.0 k
1 s	100 k	1.0 M	100 k	1.0 M	100 k	1.0 M
2 s	100 k	2.0 M	100 k	2.0 M	100 k	2.0 M
3 s	100 k	3.0 M	100 k	3.0 M	100 k	3.0 M
4 s	100 k	4.0 M	100 k	4.0 M	100 k	4.0 M
5 s	100 k	5.0 M	100 k	5.0 M	100 k	5.0 M
6 s	100 k	6.0 M	100 k	6.0 M	100 k	6.0 M
10 s	100 k	10.0 M	100 k	10.0 M	100 k	10.0 M
20 s	100 k	20.0 M	100 k	20.0 M	100 k	20.0 M
30 s	100 k	30.0 M	100 k	30.0 M	100 k	30.0 M
1 min	100 k	60.0 M	100 k	60.0 M	100 k	60.0 M
2 min	100 k	120.0 M	100 k	120.0 M	100 k	120.0 M
3 min	100 k	180.0 M	100 k	180.0 M	100 k	180.0 M
4 min	100 k	240.0 M	100 k	240.0 M	100 k	240.0 M
5 min	100 k	300.0 M	100 k	300.0 M	100 k	300.0 M
6 min	100 k	360.0 M	100 k	360.0 M	100 k	360.0 M
10 min	100 k	600.0 M	100 k	600.0 M	100 k	600.0 M
12 min	100 k	720.0 M	100 k	720.0 M	100 k	720.0 M
30 min	50 k	900.0 M	100 k	1.8 G	100 k	1.8 G

If Time/div is set to 1 hour or more, see [M-24] All Modules table.

 : The dual capture (low-speed side) setting range.

If the time scale is set to 100 ms/div or more in scope mode, roll mode display is used when the trigger mode is auto, auto level, single, or on-start.

Module's Maximum Sample Rate: All Modules

[M-21]	SSD Recording	OFF (memory recording)
	Module's maximum sample rate	All Modules
	Set record length	10 k, 25 k, 50 k, 100 k, 250 kpoint

Time/div	Set record length									
	10 kpoint		25 kpoint		50 kpoint		100 kpoint		250 kpoint	
	Sample Rate (S/s)	Display Record Length (Points)	Sample Rate (S/s)	Display Record Length (Points)	Sample Rate (S/s)	Display Record Length (Points)	Sample Rate (S/s)	Display Record Length (Points)	Sample Rate (S/s)	Display Record Length (Points)
1 hour	-	-	-	-	-	-	-	-	5	180.0 k
2 hour	-	-	-	-	-	-	-	-	-	-
3 hour	-	-	-	-	-	-	-	-	-	-
4 hour	-	-	-	-	-	-	-	-	-	-
5 hour	-	-	-	-	-	-	-	-	-	-
6 hour	-	-	-	-	-	-	-	-	-	-
8 hour	-	-	-	-	-	-	-	-	-	-
10 hour	-	-	-	-	-	-	-	-	-	-
12 hour	-	-	-	-	-	-	-	-	-	-
1 day	-	-	-	-	-	-	-	-	-	-
2 day	-	-	-	-	-	-	-	-	-	-
3 day	-	-	-	-	-	-	-	-	-	-
4 day	-	-	-	-	-	-	-	-	-	-
5 day	-	-	-	-	-	-	-	-	-	-

[M-22]	SSD Recording	OFF (memory recording)
	Module's maximum sample rate	All Modules
	Set record length	500 k, 1 M, 2.5 M, 5 M, 10 Mpoint

Time/div	Set record length									
	500 kpoint		1 Mpoints		2.5 Mpoints		5 Mpoints		10 Mpoints	
	Sample Rate (S/s)	Display Record Length (Points)	Sample Rate (S/s)	Display Record Length (Points)	Sample Rate (S/s)	Display Record Length (Points)	Sample Rate (S/s)	Display Record Length (Points)	Sample Rate (S/s)	Display Record Length (Points)
1 hour	10	360.0 k	20	720.0 k	50	1.8 M	100	3.6 M	200	7.2 M
2 hour	5	360.0 k	10	720.0 k	20	1.4 M	50	3.6 M	100	7.2 M
3 hour	-	-	5	540.0 k	20	2.1 M	20	2.1 M	50	5.4 M
4 hour	-	-	5	720.0 k	10	1.4 M	20	2.8 M	50	7.2 M
5 hour	-	-	5	900.0 k	10	1.8 M	20	3.6 M	50	9.0 M
6 hour	-	-	-	-	10	2.1 M	20	4.3 M	20	4.3 M
8 hour	-	-	-	-	5	1.4 M	10	2.8 M	20	5.7 M
10 hour	-	-	-	-	5	1.8 M	10	3.6 M	20	7.2 M
12 hour	-	-	-	-	5	2.1 M	10	4.3 M	20	8.6 M
1 day	-	-	-	-	-	-	5	4.3 M	10	8.6 M
2 day	-	-	-	-	-	-	-	-	5	8.6 M
3 day	-	-	-	-	-	-	-	-	-	-
4 day	-	-	-	-	-	-	-	-	-	-
5 day	-	-	-	-	-	-	-	-	-	-

: The dual capture (low-speed side) setting range.

If the time scale is set to 100 ms/div or more in scope mode, roll mode display is used when the trigger mode is auto, auto level, single, or on-start.

Appendix 2 Relationship between the Time Scale, Sample Rate, and Record Length (Scope mode only)

[M-23]	SSD Recording	OFF (memory recording)
	Module's maximum sample rate	All Modules
	Set record length	25 M, 50 M, 100 M, 250 M, 500 Mpoint

Time/div	Set record length									
	25 Mpoints		50 Mpoints		100 Mpoints		250 Mpoints		500 Mpoints	
	Sample Rate (S/s)	Display Record Length (Points)	Sample Rate (S/s)	Display Record Length (Points)	Sample Rate (S/s)	Display Record Length (Points)	Sample Rate (S/s)	Display Record Length (Points)	Sample Rate (S/s)	Display Record Length (Points)
1 hour	500	18.0 M	1 k	36.0 M	2 k	72.0 M	5 k	180.0 M	10 k	360.0 M
2 hour	200	14.4 M	500	36.0 M	1 k	72.0 M	2 k	144.0 M	5 k	360.0 M
3 hour	200	21.6 M	200	21.6 M	500	54.0 M	2 k	216.0 M	2 k	216.0 M
4 hour	100	14.4 M	200	28.8 M	500	72.0 M	1 k	144.0 M	2 k	288.0 M
5 hour	100	18.0 M	200	36.0 M	500	90.0 M	1 k	180.0 M	2 k	360.0 M
6 hour	100	21.6 M	200	43.2 M	200	43.2 M	1 k	216.0 M	2 k	432.0 M
8 hour	50	14.4 M	100	28.8 M	200	57.6 M	500	144.0 M	1 k	288.0 M
10 hour	50	18.0 M	100	36.0 M	200	72.0 M	500	180.0 M	1 k	360.0 M
12 hour	50	21.6 M	100	43.2 M	200	86.4 M	500	216.0 M	1 k	432.0 M
1 day	20	17.2 M	50	43.2 M	100	86.4 M	200	172.8 M	500	432.0 M
2 day	10	17.2 M	20	34.5 M	50	86.4 M	100	172.8 M	200	345.6 M
3 day	5	12.9 M	10	25.9 M	20	51.8 M	50	129.6 M	100	259.2 M
4 day	5	17.2 M	10	34.5 M	20	69.1 M	50	172.8 M	100	345.6 M
5 day	5	21.6 M	10	43.2 M	20	86.4 M	50	216.0 M	100	432.0 M

: The dual capture (low-speed side) setting range.

If the time scale is set to 100 ms/div or more in scope mode, roll mode display is used when the trigger mode is auto, auto level, single, or on-start.

[M-24]	SSD Recording	OFF (memory recording)
	Module's maximum sample rate	All Modules
	Set record length	1 G, 2 G, 4 Gpoint

Time/div	Set record length					
	1 Gpoint		2 Gpoint		4 Gpoint	
	Sample Rate (S/s)	Display Record Length (Points)	Sample Rate (S/s)	Display Record Length (Points)	Sample Rate (S/s)	Display Record Length (Points)
1 hour	20 k	720.0 M	50 k	1.8 G	100 k	3.6 G
2 hour	10 k	720.0 M	20 k	1.44 G	50 k	3.6 G
3 hour	5 k	540.0 M	10 k	1.08 G	20 k	2.16 G
4 hour	5 k	720.0 M	10 k	1.44 G	20 k	2.88 G
5 hour	5 k	900.0 M	10 k	1.8 G	20 k	3.6 G
6 hour	2 k	432.0 M	5 k	1.08 G	10 k	2.16 G
8 hour	2 k	576.0 M	5 k	1.44 G	10 k	2.88 G
10 hour	2 k	720.0 M	5 k	1.8 G	10 k	3.6 G
12 hour	2 k	864.0 M	2 k	864.0 M	5 k	2.16 G
1 day	1 k	864.0 M	2 k	1.728 G	2 k	1.728 G
2 day	500	864.0 M	1 k	1.728 G	2 k	3.456 G
3 day	200	518.4 M	500	1.296 G	1 k	2.592 G
4 day	200	691.2 M	500	1.728 G	1 k	3.456 G
5 day	200	864.0 M	200	864.0 M	500	2.16 G

: The dual capture (low-speed side) setting range.

If the time scale is set to 100 ms/div or more in scope mode, roll mode display is used when the trigger mode is auto, auto level, single, or on-start.

SSD Recording

Module's Maximum Sample Rate: 10 MS/s, 100 MS/s, 200 MS/s

[S-1]	SSD Recording	ON
	Module's maximum sample rate	10 MS/s, 100 MS/s, 200 MS/s
	Set record length	1 M, 2.5 M, 5 M, 10 M, 25 Mpoint

Time/div	Set record length									
	1 Mpoints		2.5 Mpoints		5 Mpoints		10 Mpoints		25 Mpoints	
	Sample Rate (S/s)	Display Record Length (Points)	Sample Rate (S/s)	Display Record Length (Points)	Sample Rate (S/s)	Display Record Length (Points)	Sample Rate (S/s)	Display Record Length (Points)	Sample Rate (S/s)	Display Record Length (Points)
100 ms	1 M	1.0 M	2 M	2.0 M	-	-	-	-	-	-
200 ms	500 k	1.0 M	1 M	2.0 M	2 M	4.0 M	-	-	-	-
500 ms	200 k	1.0 M	500 k	2.5 M	1 M	5.0 M	2 M	10.0 M	-	-
1 s	100 k	1.0 M	200 k	2.0 M	500 k	5.0 M	1 M	10.0 M	2 M	20.0 M
2 s	50 k	1.0 M	100 k	2.0 M	200 k	4.0 M	500 k	10.0 M	1 M	20.0 M
3 s	20 k	600.0 k	50 k	1.5 M	100 k	3.0 M	200 k	6.0 M	500 k	15.0 M
4 s	20 k	800.0 k	50 k	2.0 M	100 k	4.0 M	200 k	8.0 M	500 k	20.0 M
5 s	20 k	1.0 M	50 k	2.5 M	100 k	5.0 M	200 k	10.0 M	500 k	25.0 M
6 s	10 k	600.0 k	20 k	1.2 M	50 k	3.0 M	100 k	6.0 M	200 k	12.0 M
10 s	10 k	1.0 M	20 k	2.0 M	50 k	5.0 M	100 k	10.0 M	200 k	20.0 M
20 s	5 k	1.0 M	10 k	2.0 M	20 k	4.0 M	50 k	10.0 M	100 k	20.0 M
30 s	2 k	600.0 k	5 k	1.5 M	10 k	3.0 M	20 k	6.0 M	50 k	15.0 M
1 min	1 k	600.0 k	2 k	1.2 M	5 k	3.0 M	10 k	6.0 M	20 k	12.0 M
2 min	500	600.0 k	2 k	2.4 M	2 k	2.4 M	5 k	6.0 M	20 k	24.0 M
3 min	500	900.0 k	1 k	1.8 M	2 k	3.6 M	5 k	9.0 M	10 k	18.0 M
4 min	200	480.0 k	1 k	2.4 M	2 k	4.8 M	2 k	4.8 M	10 k	24.0 M
5 min	200	600.0 k	500	1.5 M	1 k	3.0 M	2 k	6.0 M	5 k	15.0 M
6 min	200	720.0 k	500	1.8 M	1 k	3.6 M	2 k	7.2 M	5 k	18.0 M
10 min	100	600.0 k	200	1.2 M	500	3.0 M	1 k	6.0 M	2 k	12.0 M
12 min	100	720.0 k	200	1.4 M	500	3.6 M	1 k	7.2 M	2 k	14.4 M
30 min	50	900.0 k	100	1.8 M	200	3.6 M	500	9.0 M	1 k	18.0 M
1 hour	20	720.0 k	50	1.8 M	100	3.6 M	200	7.2 M	500	18.0 M
2 hour	10	720.0 k	20	1.4 M	50	3.6 M	100	7.2 M	200	14.4 M
3 hour	5	540.0 k	20	2.1 M	20	2.1 M	50	5.4 M	200	21.6 M
4 hour	5	720.0 k	10	1.4 M	20	2.8 M	50	7.2 M	100	14.4 M
5 hour	5	900.0 k	10	1.8 M	20	3.6 M	50	9.0 M	100	18.0 M
6 hour	-	-	10	2.1 M	20	4.3 M	20	4.3 M	100	21.6 M
8 hour	-	-	5	1.4 M	10	2.8 M	20	5.7 M	50	14.4 M
10 hour	-	-	5	1.8 M	10	3.6 M	20	7.2 M	50	18.0 M
12 hour	-	-	5	2.1 M	10	4.3 M	20	8.6 M	50	21.6 M
1 day	-	-	-	-	5	4.3 M	10	8.6 M	20	17.2 M
2 day	-	-	-	-	-	-	5	8.6 M	10	17.2 M
3 day	-	-	-	-	-	-	-	-	5	12.9 M
4 day	-	-	-	-	-	-	-	-	5	17.2 M
5 day	-	-	-	-	-	-	-	-	5	21.6 M

Appendix 2 Relationship between the Time Scale, Sample Rate, and Record Length (Scope mode only)

[S-2]	SSD Recording	ON
	Module's maximum sample rate	10 MS/s, 100 MS/s, 200 MS/s
	Set record length	50 M, 100 M, 250 M, 500 M, 1 Gpoint

Time/div	Set record length									
	50 Mpoints		100 Mpoints		250 Mpoints		500 Mpoints		1 Gpoint	
	Sample Rate (S/s)	Display Record Length (Points)	Sample Rate (S/s)	Display Record Length (Points)	Sample Rate (S/s)	Display Record Length (Points)	Sample Rate (S/s)	Display Record Length (Points)	Sample Rate (S/s)	Display Record Length (Points)
100 ms	-	-	-	-	-	-	-	-	-	-
200 ms	-	-	-	-	-	-	-	-	-	-
500 ms	-	-	-	-	-	-	-	-	-	-
1 s	-	-	-	-	-	-	-	-	-	-
2 s	2 M	40.0 M	-	-	-	-	-	-	-	-
3 s	1 M	30.0 M	2 M	60.0 M	-	-	-	-	-	-
4 s	1 M	40.0 M	2 M	80.0 M	-	-	-	-	-	-
5 s	1 M	50.0 M	2 M	100.0 M	-	-	-	-	-	-
6 s	500 k	30.0 M	1 M	60.0 M	2 M	120.0 M	-	-	-	-
10 s	500 k	50.0 M	1 M	100.0 M	2 M	200.0 M	-	-	-	-
20 s	200 k	40.0 M	500 k	100.0 M	1 M	200.0 M	2 M	400.0 M	-	-
30 s	100 k	30.0 M	200 k	60.0 M	500 k	150.0 M	1 M	300.0 M	2 M	600.0 M
1 min	50 k	30.0 M	100 k	60.0 M	200 k	120.0 M	500 k	300.0 M	1 M	600.0 M
2 min	20 k	24.0 M	50 k	60.0 M	200 k	240.0 M	200 k	240.0 M	500 k	600.0 M
3 min	20 k	36.0 M	50 k	90.0 M	100 k	180.0 M	200 k	360.0 M	500 k	900.0 M
4 min	20 k	48.0 M	20 k	48.0 M	100 k	240.0 M	200 k	480.0 M	200 k	480.0 M
5 min	10 k	30.0 M	20 k	60.0 M	50 k	150.0 M	100 k	300.0 M	200 k	600.0 M
6 min	10 k	36.0 M	20 k	72.0 M	50 k	180.0 M	100 k	360.0 M	200 k	720.0 M
10 min	5 k	30.0 M	10 k	60.0 M	20 k	120.0 M	50 k	300.0 M	100 k	600.0 M
12 min	5 k	36.0 M	10 k	72.0 M	20 k	144.0 M	50 k	360.0 M	100 k	720.0 M
30 min	2 k	36.0 M	5 k	90.0 M	10 k	180.0 M	20 k	360.0 M	50 k	900.0 M
1 hour	1 k	36.0 M	2 k	72.0 M	5 k	180.0 M	10 k	360.0 M	20 k	720.0 M
2 hour	500	36.0 M	1 k	72.0 M	2 k	144.0 M	5 k	360.0 M	10 k	720.0 M
3 hour	200	21.6 M	500	54.0 M	2 k	216.0 M	2 k	216.0 M	5 k	540.0 M
4 hour	200	28.8 M	500	72.0 M	1 k	144.0 M	2 k	288.0 M	5 k	720.0 M
5 hour	200	36.0 M	500	90.0 M	1 k	180.0 M	2 k	360.0 M	5 k	900.0 M
6 hour	200	43.2 M	200	43.2 M	1 k	216.0 M	2 k	432.0 M	2 k	432.0 M
8 hour	100	28.8 M	200	57.6 M	500	144.0 M	1 k	288.0 M	2 k	576.0 M
10 hour	100	36.0 M	200	72.0 M	500	180.0 M	1 k	360.0 M	2 k	720.0 M
12 hour	100	43.2 M	200	86.4 M	500	216.0 M	1 k	432.0 M	2 k	864.0 M
1 day	50	43.2 M	100	86.4 M	200	172.8 M	500	432.0 M	1 k	864.0 M
2 day	20	34.5 M	50	86.4 M	100	172.8 M	200	345.6 M	500	864.0 M
3 day	10	25.9 M	20	51.8 M	50	129.6 M	100	259.2 M	200	518.4 M
4 day	10	34.5 M	20	69.1 M	50	172.8 M	100	345.6 M	200	691.2 M
5 day	10	43.2 M	20	86.4 M	50	216.0 M	100	432.0 M	200	864.0 M

Appendix 2 Relationship between the Time Scale, Sample Rate, and Record Length (Scope mode only)

[S-3]	SSD Recording	ON
	Module's maximum sample rate	10 MS/s, 100 MS/s, 200 MS/s
	Set record length	2 G, 4 G, 5 G, 10 G, 20 Gpoint

Time/div	Set record length									
	2 Gpoint		4 Gpoint		5 Gpoint		10 Gpoint		20 Gpoint	
	Sample Rate (S/s)	Display Record Length (Points)	Sample Rate (S/s)	Display Record Length (Points)	Sample Rate (S/s)	Display Record Length (Points)	Sample Rate (S/s)	Display Record Length (Points)	Sample Rate (S/s)	Display Record Length (Points)
100 ms	-	-	-	-	-	-	-	-	-	-
200 ms	-	-	-	-	-	-	-	-	-	-
500 ms	-	-	-	-	-	-	-	-	-	-
1 s	-	-	-	-	-	-	-	-	-	-
2 s	-	-	-	-	-	-	-	-	-	-
3 s	-	-	-	-	-	-	-	-	-	-
4 s	-	-	-	-	-	-	-	-	-	-
5 s	-	-	-	-	-	-	-	-	-	-
6 s	-	-	-	-	-	-	-	-	-	-
10 s	-	-	-	-	-	-	-	-	-	-
20 s	-	-	-	-	-	-	-	-	-	-
30 s	-	-	-	-	-	-	-	-	-	-
1 min	2 M	1.2 G	-	-	-	-	-	-	-	-
2 min	1 M	1.2 G	2 M	2.4 G	2 M	2.4 G	-	-	-	-
3 min	1 M	1.8 G	2 M	3.6 G	2 M	3.6 G	-	-	-	-
4 min	500 k	1.2 G	1 M	2.4 G	2 M	4.8 G	2 M	4.8 G	-	-
5 min	500 k	1.5 G	1 M	3 G	1 M	3 G	2 M	6.0 G	-	-
6 min	500 k	1.8 G	1 M	3.6 G	1 M	3.6 G	2 M	7.2 G	-	-
10 min	200 k	1.2 G	500 k	3 G	500 k	3 G	1 M	6.0 G	2 M	12.0 G
12 min	200 k	1.44 G	500 k	3.6 G	500 k	3.6 G	1 M	7.2 G	1 M	14.4 G
30 min	100 k	1.8 G	200 k	3.6 G	200 k	3.6 G	500 k	9.0 G	1 M	18.0 G
1 hour	50 k	1.8 G	100 k	3.6 G	100 k	3.6 G	200 k	7.2 G	500 k	18.0 G
2 hour	20 k	1.44 G	50 k	3.6 G	50 k	3.6 G	100 k	7.2 G	200 k	14.4 G
3 hour	10 k	1.08 G	20 k	2.16 G	20 k	2.16 G	50 k	5.4 G	100 k	10.8 G
4 hour	10 k	1.44 G	20 k	2.88 G	20 k	2.88 G	50 k	7.2 G	100 k	14.4 G
5 hour	10 k	1.8 G	20 k	3.6 G	20 k	3.6 G	50 k	9.0 G	100 k	18.0 G
6 hour	5 k	1.08 G	10 k	2.16 G	20 k	4.32 G	20 k	4.32 G	50 k	10.8 G
8 hour	5 k	1.44 G	10 k	2.88 G	10 k	2.88 G	20 k	5.76 G	50 k	14.4 G
10 hour	5 k	1.8 G	10 k	3.6 G	10 k	3.6 G	20 k	7.2 G	50 k	18.0 G
12 hour	2 k	864.0 M	5 k	2.16 G	10 k	4.32 G	20 k	8.64 G	20 k	8.64 G
1 day	2 k	1.728 G	2 k	1.728 G	5 k	4.32 G	10 k	8.64 G	20 k	17.28 G
2 day	1 k	1.728 G	2 k	3.456 G	2 k	3.456 G	5 k	8.64 G	10 k	17.28 G
3 day	500	1.296 G	1 k	2.592 G	1 k	2.592 G	2 k	5.184 G	5 k	12.96 G
4 day	500	1.728 G	1 k	3.456 G	1 k	3.456 G	2 k	6.912 G	5 k	17.28 G
5 day	200	864.0 M	500	2.16 G	1 k	4.32 G	2 k	8.64 G	2 k	8.64 G

Appendix 2 Relationship between the Time Scale, Sample Rate, and Record Length (Scope mode only)

[S-4]	SSD Recording	ON
	Module's maximum sample rate	10 MS/s, 100 MS/s, 200 MS/s
	Set record length	50 Gpoint

Time/div	Set record length 50 Gpoint	
	Sample Rate (S/s)	Display Record Length (Points)
100 ms	-	-
200 ms	-	-
500 ms	-	-
1 s	-	-
2 s	-	-
3 s	-	-
4 s	-	-
5 s	-	-
6 s	-	-
10 s	-	-
20 s	-	-
30 s	-	-
1 min	-	-
2 min	-	-
3 min	-	-
4 min	-	-
5 min	-	-
6 min	-	-
10 min	-	-
12 min	-	-
30 min	2 M	36.0 G
1 hour	1 M	36.0 G
2 hour	500 k	36.0 G
3 hour	200 k	21.6 G
4 hour	200 k	28.8 G
5 hour	200 k	36.0 G
6 hour	200 k	43.2 G
8 hour	100 k	28.8 G
10 hour	100 k	36.0 G
12 hour	100 k	43.2 G
1 day	50 k	43.2 G
2 day	20 k	34.56 G
3 day	10 k	25.92 G
4 day	10 k	34.56 G
5 day	10 k	43.2 G

Appendix 2 Relationship between the Time Scale, Sample Rate, and Record Length (Scope mode only)

Module's Maximum Sample Rate: 1 MS/s

[S-5]	SSD Recording	ON
	Module's maximum sample rate	1 MS/s
	Set record length	1 M, 2.5 M, 5 M, 10 M, 25 Mpoint

Time/div	Set record length									
	1 Mpoints		2.5 Mpoints		5 Mpoints		10 Mpoints		25 Mpoints	
	Sample Rate (S/s)	Display Record Length (Points)	Sample Rate (S/s)	Display Record Length (Points)	Sample Rate (S/s)	Display Record Length (Points)	Sample Rate (S/s)	Display Record Length (Points)	Sample Rate (S/s)	Display Record Length (Points)
100 ms	1 M	1.0 M	-	-	-	-	-	-	-	-
200 ms	500 k	1.0 M	1 M	2.0 M	-	-	-	-	-	-
500 ms	200 k	1.0 M	500 k	2.5 M	1 M	5.0 M	-	-	-	-
1 s	100 k	1.0 M	200 k	2.0 M	500 k	5.0 M	1 M	10.0 M	-	-
2 s	50 k	1.0 M	100 k	2.0 M	200 k	4.0 M	500 k	10.0 M	1 M	20.0 M
3 s	20 k	600.0 k	50 k	1.5 M	100 k	3.0 M	200 k	6.0 M	500 k	15.0 M
4 s	20 k	800.0 k	50 k	2.0 M	100 k	4.0 M	200 k	8.0 M	500 k	20.0 M
5 s	20 k	1.0 M	50 k	2.5 M	100 k	5.0 M	200 k	10.0 M	500 k	25.0 M
6 s	10 k	600.0 k	20 k	1.2 M	50 k	3.0 M	100 k	6.0 M	200 k	12.0 M
10 s	10 k	1.0 M	20 k	2.0 M	50 k	5.0 M	100 k	10.0 M	200 k	20.0 M
20 s	5 k	1.0 M	10 k	2.0 M	20 k	4.0 M	50 k	10.0 M	100 k	20.0 M
30 s	2 k	600.0 k	5 k	1.5 M	10 k	3.0 M	20 k	6.0 M	50 k	15.0 M
1 min	1 k	600.0 k	2 k	1.2 M	5 k	3.0 M	10 k	6.0 M	20 k	12.0 M
2 min	500	600.0 k	2 k	2.4 M	2 k	2.4 M	5 k	6.0 M	20 k	24.0 M
3 min	500	900.0 k	1 k	1.8 M	2 k	3.6 M	5 k	9.0 M	10 k	18.0 M
4 min	200	480.0 k	1 k	2.4 M	2 k	4.8 M	2 k	4.8 M	10 k	24.0 M
5 min	200	600.0 k	500	1.5 M	1 k	3.0 M	2 k	6.0 M	5 k	15.0 M
6 min	200	720.0 k	500	1.8 M	1 k	3.6 M	2 k	7.2 M	5 k	18.0 M
10 min	100	600.0 k	200	1.2 M	500	3.0 M	1 k	6.0 M	2 k	12.0 M
12 min	100	720.0 k	200	1.4 M	500	3.6 M	1 k	7.2 M	2 k	14.4 M
30 min	50	900.0 k	100	1.8 M	200	3.6 M	500	9.0 M	1 k	18.0 M
1 hour	20	720.0 k	50	1.8 M	100	3.6 M	200	7.2 M	500	18.0 M
2 hour	10	720.0 k	20	1.4 M	50	3.6 M	100	7.2 M	200	14.4 M
3 hour	5	540.0 k	20	2.1 M	20	2.1 M	50	5.4 M	200	21.6 M
4 hour	5	720.0 k	10	1.4 M	20	2.8 M	50	7.2 M	100	14.4 M
5 hour	5	900.0 k	10	1.8 M	20	3.6 M	50	9.0 M	100	18.0 M
6 hour	-	-	10	2.1 M	20	4.3 M	20	4.3 M	100	21.6 M
8 hour	-	-	5	1.4 M	10	2.8 M	20	5.7 M	50	14.4 M
10 hour	-	-	5	1.8 M	10	3.6 M	20	7.2 M	50	18.0 M
12 hour	-	-	5	2.1 M	10	4.3 M	20	8.6 M	50	21.6 M
1 day	-	-	-	-	5	4.3 M	10	8.6 M	20	17.2 M
2 day	-	-	-	-	-	-	5	8.6 M	10	17.2 M
3 day	-	-	-	-	-	-	-	-	5	12.9 M
4 day	-	-	-	-	-	-	-	-	5	17.2 M
5 day	-	-	-	-	-	-	-	-	5	21.6 M

Appendix 2 Relationship between the Time Scale, Sample Rate, and Record Length (Scope mode only)

[S-6]	SSD Recording	ON
	Module's maximum sample rate	1 MS/s
	Set record length	50 M, 100 M, 250 M, 500 M, 1 Gpoint

Time/div	Set record length									
	50 Mpoints		100 Mpoints		250 Mpoints		500 Mpoints		1 Gpoint	
	Sample Rate (S/s)	Display Record Length (Points)	Sample Rate (S/s)	Display Record Length (Points)	Sample Rate (S/s)	Display Record Length (Points)	Sample Rate (S/s)	Display Record Length (Points)	Sample Rate (S/s)	Display Record Length (Points)
100 ms	-	-	-	-	-	-	-	-	-	-
200 ms	-	-	-	-	-	-	-	-	-	-
500 ms	-	-	-	-	-	-	-	-	-	-
1 s	-	-	-	-	-	-	-	-	-	-
2 s	-	-	-	-	-	-	-	-	-	-
3 s	1 M	30.0 M	-	-	-	-	-	-	-	-
4 s	1 M	40.0 M	-	-	-	-	-	-	-	-
5 s	1 M	50.0 M	-	-	-	-	-	-	-	-
6 s	500 k	30.0 M	1 M	60.0 M	-	-	-	-	-	-
10 s	500 k	50.0 M	1 M	100.0 M	-	-	-	-	-	-
20 s	200 k	40.0 M	500 k	100.0 M	1 M	200.0 M	-	-	-	-
30 s	100 k	30.0 M	200 k	60.0 M	500 k	150.0 M	1 M	300.0 M	-	-
1 min	50 k	30.0 M	100 k	60.0 M	200 k	120.0 M	500 k	300.0 M	1 M	600.0 M
2 min	20 k	24.0 M	50 k	60.0 M	200 k	240.0 M	200 k	240.0 M	500 k	600.0 M
3 min	20 k	36.0 M	50 k	90.0 M	100 k	180.0 M	200 k	360.0 M	500 k	900.0 M
4 min	20 k	48.0 M	20 k	48.0 M	100 k	240.0 M	200 k	480.0 M	200 k	480.0 M
5 min	10 k	30.0 M	20 k	60.0 M	50 k	150.0 M	100 k	300.0 M	200 k	600.0 M
6 min	10 k	36.0 M	20 k	72.0 M	50 k	180.0 M	100 k	360.0 M	200 k	720.0 M
10 min	5 k	30.0 M	10 k	60.0 M	20 k	120.0 M	50 k	300.0 M	100 k	600.0 M
12 min	5 k	36.0 M	10 k	72.0 M	20 k	144.0 M	50 k	360.0 M	100 k	720.0 M
30 min	2 k	36.0 M	5 k	90.0 M	10 k	180.0 M	20 k	360.0 M	50 k	900.0 M
1 hour	1 k	36.0 M	2 k	72.0 M	5 k	180.0 M	10 k	360.0 M	20 k	720.0 M
2 hour	500	36.0 M	1 k	72.0 M	2 k	144.0 M	5 k	360.0 M	10 k	720.0 M
3 hour	200	21.6 M	500	54.0 M	2 k	216.0 M	2 k	216.0 M	5 k	540.0 M
4 hour	200	28.8 M	500	72.0 M	1 k	144.0 M	2 k	288.0 M	5 k	720.0 M
5 hour	200	36.0 M	500	90.0 M	1 k	180.0 M	2 k	360.0 M	5 k	900.0 M
6 hour	200	43.2 M	200	43.2 M	1 k	216.0 M	2 k	432.0 M	2 k	432.0 M
8 hour	100	28.8 M	200	57.6 M	500	144.0 M	1 k	288.0 M	2 k	576.0 M
10 hour	100	36.0 M	200	72.0 M	500	180.0 M	1 k	360.0 M	2 k	720.0 M
12 hour	100	43.2 M	200	86.4 M	500	216.0 M	1 k	432.0 M	2 k	864.0 M
1 day	50	43.2 M	100	86.4 M	200	172.8 M	500	432.0 M	1 k	864.0 M
2 day	20	34.5 M	50	86.4 M	100	172.8 M	200	345.6 M	500	864.0 M
3 day	10	25.9 M	20	51.8 M	50	129.6 M	100	259.2 M	200	518.4 M
4 day	10	34.5 M	20	69.1 M	50	172.8 M	100	345.6 M	200	691.2 M
5 day	10	43.2 M	20	86.4 M	50	216.0 M	100	432.0 M	200	864.0 M

Appendix 2 Relationship between the Time Scale, Sample Rate, and Record Length (Scope mode only)

[S-7]	SSD Recording	ON
	Module's maximum sample rate	1 MS/s
	Set record length	2 G, 4 G, 5 G, 10 G, 20 Gpoint

Time/div	Set record length									
	2 Gpoint		4 Gpoint		5 Gpoint		10 Gpoint		20 Gpoint	
	Sample Rate (S/s)	Display Record Length (Points)	Sample Rate (S/s)	Display Record Length (Points)	Sample Rate (S/s)	Display Record Length (Points)	Sample Rate (S/s)	Display Record Length (Points)	Sample Rate (S/s)	Display Record Length (Points)
100 ms	-	-	-	-	-	-	-	-	-	-
200 ms	-	-	-	-	-	-	-	-	-	-
500 ms	-	-	-	-	-	-	-	-	-	-
1 s	-	-	-	-	-	-	-	-	-	-
2 s	-	-	-	-	-	-	-	-	-	-
3 s	-	-	-	-	-	-	-	-	-	-
4 s	-	-	-	-	-	-	-	-	-	-
5 s	-	-	-	-	-	-	-	-	-	-
6 s	-	-	-	-	-	-	-	-	-	-
10 s	-	-	-	-	-	-	-	-	-	-
20 s	-	-	-	-	-	-	-	-	-	-
30 s	-	-	-	-	-	-	-	-	-	-
1 min	-	-	-	-	-	-	-	-	-	-
2 min	1 M	1.2 G	-	-	-	-	-	-	-	-
3 min	1 M	1.8 G	-	-	-	-	-	-	-	-
4 min	500 k	1.2 G	1 M	2.4 G	-	-	-	-	-	-
5 min	500 k	1.5 G	1 M	3 G	1 M	3 G	-	-	-	-
6 min	500 k	1.8 G	1 M	3.6 G	1 M	3.6 G	-	-	-	-
10 min	200 k	1.2 G	500 k	3 G	500 k	3 G	1 M	6.0 G	-	-
12 min	200 k	1.44 G	500 k	3.6 G	500 k	3.6 G	1 M	7.2 G	-	-
30 min	100 k	1.8 G	200 k	3.6 G	200 k	3.6 G	500 k	9.0 G	1 M	18.0 G
1 hour	50 k	1.8 G	100 k	3.6 G	100 k	3.6 G	200 k	7.2 G	500 k	18.0 G
2 hour	20 k	1.44 G	50 k	3.6 G	50 k	3.6 G	100 k	7.2 G	200 k	14.4 G
3 hour	10 k	1.08 G	20 k	2.16 G	20 k	2.16 G	50 k	5.4 G	100 k	10.8 G
4 hour	10 k	1.44 G	20 k	2.88 G	20 k	2.88 G	50 k	7.2 G	100 k	14.4 G
5 hour	10 k	1.8 G	20 k	3.6 G	20 k	3.6 G	50 k	9.0 G	100 k	18.0 G
6 hour	5 k	1.08 G	10 k	2.16 G	20 k	4.32 G	20 k	4.32 G	50 k	10.8 G
8 hour	5 k	1.44 G	10 k	2.88 G	10 k	2.88 G	20 k	5.76 G	50 k	14.4 G
10 hour	5 k	1.8 G	10 k	3.6 G	10 k	3.6 G	20 k	7.2 G	50 k	18.0 G
12 hour	2 k	864.0 M	5 k	2.16 G	10 k	4.32 G	20 k	8.64 G	20 k	8.64 G
1 day	2 k	1.728 G	2 k	1.728 G	5 k	4.32 G	10 k	8.64 G	20 k	17.28 G
2 day	1 k	1.728 G	2 k	3.456 G	2 k	3.456 G	5 k	8.64 G	10 k	17.28 G
3 day	500	1.296 G	1 k	2.592 G	1 k	2.592 G	2 k	5.184 G	5 k	12.96 G
4 day	500	1.728 G	1 k	3.456 G	1 k	3.456 G	2 k	6.912 G	5 k	17.28 G
5 day	200	864.0 M	500	2.16 G	1 k	4.32 G	2 k	8.64 G	2 k	8.64 G

Appendix 2 Relationship between the Time Scale, Sample Rate, and Record Length (Scope mode only)

[S-8]	SSD Recording	ON
	Module's maximum sample rate	1 MS/s
	Set record length	50 Gpoint

Time/div	Set record length 50 Gpoint	
	Sample Rate (S/s)	Display Record Length (Points)
100 ms	-	-
200 ms	-	-
500 ms	-	-
1 s	-	-
2 s	-	-
3 s	-	-
4 s	-	-
5 s	-	-
6 s	-	-
10 s	-	-
20 s	-	-
30 s	-	-
1 min	-	-
2 min	-	-
3 min	-	-
4 min	-	-
5 min	-	-
6 min	-	-
10 min	-	-
12 min	-	-
30 min	-	-
1 hour	1 M	36.0 G
2 hour	500 k	36.0 G
3 hour	200 k	21.6 G
4 hour	200 k	28.8 G
5 hour	200 k	36.0 G
6 hour	200 k	43.2 G
8 hour	100 k	28.8 G
10 hour	100 k	36.0 G
12 hour	100 k	43.2 G
1 day	50 k	43.2 G
2 day	20 k	34.56 G
3 day	10 k	25.92 G
4 day	10 k	34.56 G
5 day	10 k	43.2 G

Appendix 2 Relationship between the Time Scale, Sample Rate, and Record Length (Scope mode only)

Module's Maximum Sample Rate: 100 kS/s

[S-9]	SSD Recording	ON
	Module's maximum sample rate	100 kS/s
	Set record length	1 M, 2.5 M, 5 M, 10 M, 25 Mpoint

Time/div	Set record length									
	1 Mpoints		2.5 Mpoints		5 Mpoints		10 Mpoints		25 Mpoints	
	Sample Rate (S/s)	Display Record Length (Points)	Sample Rate (S/s)	Display Record Length (Points)	Sample Rate (S/s)	Display Record Length (Points)	Sample Rate (S/s)	Display Record Length (Points)	Sample Rate (S/s)	Display Record Length (Points)
1 s	100 k	1.0 M	-	-	-	-	-	-	-	-
2 s	50 k	1.0 M	100 k	2.0 M	-	-	-	-	-	-
3 s	20 k	600.0 k	50 k	1.5 M	100 k	3.0 M	-	-	-	-
4 s	20 k	800.0 k	50 k	2.0 M	100 k	4.0 M	-	-	-	-
5 s	20 k	1.0 M	50 k	2.5 M	100 k	5.0 M	-	-	-	-
6 s	10 k	600.0 k	20 k	1.2 M	50 k	3.0 M	100 k	6.0 M	-	-
10 s	10 k	1.0 M	20 k	2.0 M	50 k	5.0 M	100 k	10.0 M	-	-
20 s	5 k	1.0 M	10 k	2.0 M	20 k	4.0 M	50 k	10.0 M	100 k	20.0 M
30 s	2 k	600.0 k	5 k	1.5 M	10 k	3.0 M	20 k	6.0 M	50 k	15.0 M
1 min	1 k	600.0 k	2 k	1.2 M	5 k	3.0 M	10 k	6.0 M	20 k	12.0 M
2 min	500	600.0 k	2 k	2.4 M	2 k	2.4 M	5 k	6.0 M	20 k	24.0 M
3 min	500	900.0 k	1 k	1.8 M	2 k	3.6 M	5 k	9.0 M	10 k	18.0 M
4 min	200	480.0 k	1 k	2.4 M	2 k	4.8 M	2 k	4.8 M	10 k	24.0 M
5 min	200	600.0 k	500	1.5 M	1 k	3.0 M	2 k	6.0 M	5 k	15.0 M
6 min	200	720.0 k	500	1.8 M	1 k	3.6 M	2 k	7.2 M	5 k	18.0 M
10 min	100	600.0 k	200	1.2 M	500	3.0 M	1 k	6.0 M	2 k	12.0 M
12 min	100	720.0 k	200	1.4 M	500	3.6 M	1 k	7.2 M	2 k	14.4 M
30 min	50	900.0 k	100	1.8 M	200	3.6 M	500	9.0 M	1 k	18.0 M
1 hour	20	720.0 k	50	1.8 M	100	3.6 M	200	7.2 M	500	18.0 M
2 hour	10	720.0 k	20	1.4 M	50	3.6 M	100	7.2 M	200	14.4 M
3 hour	5	540.0 k	20	2.1 M	20	2.1 M	50	5.4 M	200	21.6 M
4 hour	5	720.0 k	10	1.4 M	20	2.8 M	50	7.2 M	100	14.4 M
5 hour	5	900.0 k	10	1.8 M	20	3.6 M	50	9.0 M	100	18.0 M
6 hour	-	-	10	2.1 M	20	4.3 M	20	4.3 M	100	21.6 M
8 hour	-	-	5	1.4 M	10	2.8 M	20	5.7 M	50	14.4 M
10 hour	-	-	5	1.8 M	10	3.6 M	20	7.2 M	50	18.0 M
12 hour	-	-	5	2.1 M	10	4.3 M	20	8.6 M	50	21.6 M
1 day	-	-	-	-	5	4.3 M	10	8.6 M	20	17.2 M
2 day	-	-	-	-	-	-	5	8.6 M	10	17.2 M
3 day	-	-	-	-	-	-	-	-	5	12.9 M
4 day	-	-	-	-	-	-	-	-	5	17.2 M
5 day	-	-	-	-	-	-	-	-	5	21.6 M

: The dual capture (low-speed side) setting range.

Appendix 2 Relationship between the Time Scale, Sample Rate, and Record Length (Scope mode only)

[S-10]	SSD Recording	ON
	Module's maximum sample rate	100 kS/s
	Set record length	50 M, 100 M, 250 M, 500 M, 1 Gpoint

Time/div	Set record length									
	50 Mpoints		100 Mpoints		250 Mpoints		500 Mpoints		1 Gpoint	
	Sample Rate (S/s)	Display Record Length (Points)	Sample Rate (S/s)	Display Record Length (Points)	Sample Rate (S/s)	Display Record Length (Points)	Sample Rate (S/s)	Display Record Length (Points)	Sample Rate (S/s)	Display Record Length (Points)
1 s	-	-	-	-	-	-	-	-	-	-
2 s	-	-	-	-	-	-	-	-	-	-
3 s	-	-	-	-	-	-	-	-	-	-
4 s	-	-	-	-	-	-	-	-	-	-
5 s	-	-	-	-	-	-	-	-	-	-
6 s	-	-	-	-	-	-	-	-	-	-
10 s	-	-	-	-	-	-	-	-	-	-
20 s	-	-	-	-	-	-	-	-	-	-
30 s	100 k	30.0 M	-	-	-	-	-	-	-	-
1 min	50 k	30.0 M	100 k	60.0 M	-	-	-	-	-	-
2 min	20 k	24.0 M	50 k	60.0 M	-	-	-	-	-	-
3 min	20 k	36.0 M	50 k	90.0 M	100 k	180.0 M	-	-	-	-
4 min	20 k	48.0 M	20 k	48.0 M	100 k	240.0 M	-	-	-	-
5 min	10 k	30.0 M	20 k	60.0 M	50 k	150.0 M	100 k	300.0 M	-	-
6 min	10 k	36.0 M	20 k	72.0 M	50 k	180.0 M	100 k	360.0 M	-	-
10 min	5 k	30.0 M	10 k	60.0 M	20 k	120.0 M	50 k	300.0 M	100 k	600.0 M
12 min	5 k	36.0 M	10 k	72.0 M	20 k	144.0 M	50 k	360.0 M	100 k	720.0 M
30 min	2 k	36.0 M	5 k	90.0 M	10 k	180.0 M	20 k	360.0 M	50 k	900.0 M
1 hour	1 k	36.0 M	2 k	72.0 M	5 k	180.0 M	10 k	360.0 M	20 k	720.0 M
2 hour	500	36.0 M	1 k	72.0 M	2 k	144.0 M	5 k	360.0 M	10 k	720.0 M
3 hour	200	21.6 M	500	54.0 M	2 k	216.0 M	2 k	216.0 M	5 k	540.0 M
4 hour	200	28.8 M	500	72.0 M	1 k	144.0 M	2 k	288.0 M	5 k	720.0 M
5 hour	200	36.0 M	500	90.0 M	1 k	180.0 M	2 k	360.0 M	5 k	900.0 M
6 hour	200	43.2 M	200	43.2 M	1 k	216.0 M	2 k	432.0 M	2 k	432.0 M
8 hour	100	28.8 M	200	57.6 M	500	144.0 M	1 k	288.0 M	2 k	576.0 M
10 hour	100	36.0 M	200	72.0 M	500	180.0 M	1 k	360.0 M	2 k	720.0 M
12 hour	100	43.2 M	200	86.4 M	500	216.0 M	1 k	432.0 M	2 k	864.0 M
1 day	50	43.2 M	100	86.4 M	200	172.8 M	500	432.0 M	1 k	864.0 M
2 day	20	34.5 M	50	86.4 M	100	172.8 M	200	345.6 M	500	864.0 M
3 day	10	25.9 M	20	51.8 M	50	129.6 M	100	259.2 M	200	518.4 M
4 day	10	34.5 M	20	69.1 M	50	172.8 M	100	345.6 M	200	691.2 M
5 day	10	43.2 M	20	86.4 M	50	216.0 M	100	432.0 M	200	864.0 M

□: The dual capture (low-speed side) setting range.

Appendix 2 Relationship between the Time Scale, Sample Rate, and Record Length (Scope mode only)

[S-11]	SSD Recording	ON
	Module's maximum sample rate	100 kS/s
	Set record length	2 G, 4 G, 5 G, 10 G, 20 Gpoint

Time/div	Set record length									
	2 Gpoint		4 Gpoint		5 Gpoint		10 Gpoint		20 Gpoint	
	Sample Rate (S/s)	Display Record Length (Points)	Sample Rate (S/s)	Display Record Length (Points)	Sample Rate (S/s)	Display Record Length (Points)	Sample Rate (S/s)	Display Record Length (Points)	Sample Rate (S/s)	Display Record Length (Points)
1 s	-	-	-	-	-	-	-	-	-	-
2 s	-	-	-	-	-	-	-	-	-	-
3 s	-	-	-	-	-	-	-	-	-	-
4 s	-	-	-	-	-	-	-	-	-	-
5 s	-	-	-	-	-	-	-	-	-	-
6 s	-	-	-	-	-	-	-	-	-	-
10 s	-	-	-	-	-	-	-	-	-	-
20 s	-	-	-	-	-	-	-	-	-	-
30 s	-	-	-	-	-	-	-	-	-	-
1 min	-	-	-	-	-	-	-	-	-	-
2 min	-	-	-	-	-	-	-	-	-	-
3 min	-	-	-	-	-	-	-	-	-	-
4 min	-	-	-	-	-	-	-	-	-	-
5 min	-	-	-	-	-	-	-	-	-	-
6 min	-	-	-	-	-	-	-	-	-	-
10 min	-	-	-	-	-	-	-	-	-	-
12 min	-	-	-	-	-	-	-	-	-	-
30 min	100 k	1.8 G	-	-	-	-	-	-	-	-
1 hour	50 k	1.8 G	100 k	3.6 G	100 k	3.6 G	-	-	-	-
2 hour	20 k	1.44 G	50 k	3.6 G	50 k	3.6 G	100 k	7.2 G	-	-
3 hour	10 k	1.08 G	20 k	2.16 G	20 k	2.16 G	50 k	5.4 G	100 k	10.8 G
4 hour	10 k	1.44 G	20 k	2.88 G	20 k	2.88 G	50 k	7.2 G	100 k	14.4 G
5 hour	10 k	1.8 G	20 k	3.6 G	20 k	3.6 G	50 k	9.0 G	100 k	18.0 G
6 hour	5 k	1.08 G	10 k	2.16 G	20 k	4.32 G	20 k	4.32 G	50 k	10.8 G
8 hour	5 k	1.44 G	10 k	2.88 G	10 k	2.88 G	20 k	5.76 G	50 k	14.4 G
10 hour	5 k	1.8 G	10 k	3.6 G	10 k	3.6 G	20 k	7.2 G	50 k	18.0 G
12 hour	2 k	864.0 M	5 k	2.16 G	10 k	4.32 G	20 k	8.64 G	20 k	8.64 G
1 day	2 k	1.728 G	2 k	1.728 G	5 k	4.32 G	10 k	8.64 G	20 k	17.28 G
2 day	1 k	1.728 G	2 k	3.456 G	2 k	3.456 G	5 k	8.64 G	10 k	17.28 G
3 day	500	1.296 G	1 k	2.592 G	1 k	2.592 G	2 k	5.184 G	5 k	12.96 G
4 day	500	1.728 G	1 k	3.456 G	1 k	3.456 G	2 k	6.912 G	5 k	17.28 G
5 day	200	864.0 M	500	2.16 G	1 k	4.32 G	2 k	8.64 G	2 k	8.64 G

: The dual capture (low-speed side) setting range.

Appendix 2 Relationship between the Time Scale, Sample Rate, and Record Length (Scope mode only)

[S-12]	SSD Recording	ON
	Module's maximum sample rate	100 kS/s
	Set record length	50 Gpoint

Time/div	Set record length 50 Gpoint	
	Sample Rate (S/s)	Display Record Length (Points)
1 s	-	-
2 s	-	-
3 s	-	-
4 s	-	-
5 s	-	-
6 s	-	-
10 s	-	-
20 s	-	-
30 s	-	-
1 min	-	-
2 min	-	-
3 min	-	-
4 min	-	-
5 min	-	-
6 min	-	-
10 min	-	-
12 min	-	-
30 min	-	-
1 hour	-	-
2 hour	-	-
3 hour	-	-
4 hour	-	-
5 hour	-	-
6 hour	-	-
8 hour	100 k	28.8 G
10 hour	100 k	36.0 G
12 hour	100 k	43.2 G
1 day	50 k	43.2 G
2 day	20 k	34.56 G
3 day	10 k	25.92 G
4 day	10 k	34.56 G
5 day	10 k	43.2 G

: The dual capture (low-speed side) setting range.

Appendix 3 Relationship between the Main Channel Sample Rate, Sub Channel Data Update Rate, and Acquisition Memory Writing Rate

For details on how to use the appendix, see appendix 1, “Using the Appendix.”

16-CH Temperature/Voltage Input Module

Rate at Which Data Is Written to the Acquisition Memory

Number of Sub Channels Used		1 to 16			
Data Update Interval		100 ms	300 ms	1 s	3 s
Main Channel Sample Rate Setting (S/s)	200 M	100 k	100 k	100 k	100 k
	100 M	100 k	100 k	100 k	100 k
	50 M	100 k	100 k	100 k	100 k
	20 M	100 k	100 k	100 k	100 k
	10 M	100 k	100 k	100 k	100 k
	5 M	100 k	100 k	100 k	100 k
	2 M	100 k	100 k	100 k	100 k
	1 M	50 k	50 k	50 k	50 k
	500 k	20 k	20 k	20 k	20 k
	200 k	10 k	10 k	10 k	10 k
	100 k	5 k	5 k	5 k	5 k
	50 k	2 k	2 k	2 k	2 k
	20 k	1 k	1 k	1 k	1 k
	10 k	500	500	500	500
	5 k	200	200	200	200
	2 k	100	100	100	100
	1 k	50	50	50	50
	500	20	20	20	20
	200	10	10	10	10
	100	5	5	5	5
50	2	2	2	2	
20	1	1	1	1	
10	—	—	—	—	
5	—	—	—	—	

: Some data will not be updated. If this occurs, previous data is displayed consecutively.

CAN Bus Monitor Module, CAN & LIN Bus Monitor Module, CAN/CAN FD Monitor Module, and SENT Monitor Module

Rate at Which Data Is Written to the Acquisition Memory

Number of Sub Channels Used		1	2	3 to 4	5 to 8	9 to 16	17 to 32	33 to 60
Sub Channel Sample Rate (Data Update Rate)		100 k	100 k	100 k	100 k	100 k	100 k	100 k
Main Channel Sample Rate Setting (S/s)	200 M	100 k	100 k	100 k	100 k	100 k	100 k	100 k
	100 M	100 k	100 k	100 k	100 k	100 k	100 k	100 k
	50 M	100 k	100 k	100 k	100 k	100 k	100 k	100 k
	20 M	100 k	100 k	100 k	100 k	100 k	100 k	100 k
	10 M	100 k	100 k	100 k	100 k	100 k	100 k	100 k
	5 M	100 k	100 k	100 k	100 k	100 k	100 k	50 k
	2 M	100 k	100 k	100 k	100 k	100 k	50 k	20 k
	1 M	100 k	100 k	100 k	100 k	50 k	20 k	10 k
	500 k	100 k	100 k	100 k	50 k	20 k	10 k	5 k
	200 k	100 k	100 k	50 k	20 k	10 k	5 k	2 k
	100 k	100 k	50 k	20 k	10 k	5 k	2 k	1 k
	50 k	50 k	10 k	10 k	5 k	2 k	1 k	500
	20 k	20 k	10 k	5 k	2 k	1 k	500	200
	10 k	10 k	5 k	2 k	1 k	500	200	100
	5 k	5 k	1 k	1 k	500	200	100	50
	2 k	2 k	1 k	500	200	100	50	20
	1 k	1 k	500	200	100	50	20	10
	500	500	100	100	50	20	10	5
	200	200	100	50	20	10	5	2
	100	100	50	20	10	5	2	1
50	50	10	10	5	2	1	—	
20	20	10	5	2	1	—	—	
10	10	5	2	1	—	—	—	
5	5	1	1	—	—	—	—	

Appendix 4 Record Length and Maximum Number of Channels

For details on how to use the appendix, see appendix 1, “Using the Appendix.”

Memory Recording

In Scope mode when dual capture is off

Set record length (Unit: points)	Standard Model	/M1 Model	/M2 Model
10 k to 10 M	64 (32)	64 (32)	64 (32)
25 M	32 (16)	64 (32)	64 (32)
50 M	16 (8)	64 (32)	64 (32)
100 M	8 (4)	32 (16)	64 (32)
250 M	4 (2)	16 (8)	32 (16)
500 M	2 (1)	8 (4)	16 (8)
1 G	—	4 (2)	8 (4)
2 G	—	2 (1)	4 (2)
4 G	—	—	2 (1)

The values inside the parentheses are the maximum number of channels in a group. For how to count the number channels, see appendix 1.

In Scope mode when dual capture is on

- Low-speed sampling

Set record length (Unit: points)	Standard Model	/M1 Model	/M2 Model
10 k to 5 M	64 (32)	64 (32)	64 (32)
10 M	32 (16)	64 (32)	64 (32)
25 M	16 (8)	64 (32)	64 (32)
50 M	8 (4)	32 (16)	64 (32)
100 M	4 (2)	16 (8)	32 (16)
250 M	2 (1)	8 (4)	16 (8)
500 M	—	4 (2)	8 (4)
1 G	—	2 (1)	4 (2)
2 G	—	—	2 (1)

The values inside the parentheses are the maximum number of channels in a group. For how to count the number channels, see appendix 1.

: This is referenced in “Examples of Using the Appendix” on page App-1.

- High-speed sampling

Set record length (Unit: points)	Standard Model	/M1 Model	/M2 Model
10 k to 2.5 M	64 (32)	64 (32)	64 (32)
5 M	32 (16)	64 (32)	64 (32)
10 M	16 (8)	64 (32)	64 (32)
25 M	8 (4)	32 (16)	64 (32)
50 M	4 (2)	16 (8)	32 (16)

The values inside the parentheses are the maximum number of channels in a group. For how to count the number channels, see appendix 1.

: This is referenced in “Examples of Using the Appendix” on page App-1.

In Recorder mode when the time base is an external clock

This is the same as when dual capture is off in memory recording.

SSD recording

In Scope mode when dual capture is off

Set record length (Unit: points)	Standard Model	/M1 Model	/M2 Model
1 M to 500 M	64 (32)	64 (32)	64 (32)
1 G	32 (16)	64 (32)	64 (32)
2 G	16 (8)	64 (32)	64 (32)
4 G	8 (4)	32 (16)	64 (32)
5 G	8 (4)	32 (16)	64 (32)
10 G	4 (2)	16 (8)	32 (16)
20 G	2 (1)	8 (4)	16 (8)
50 G	—	4 (2)	8 (4)

The values inside the parentheses are the maximum number of channels in a group. For how to count the number channels, see appendix 1.

In Scope mode when dual capture is on

- **Low-speed sampling**

This is the same as when dual capture is off in SSD recording.

- **High-speed sampling**

Set record length (Unit: points)	Standard Model	/M1 Model	/M2 Model
10 k to 1 M	64 (32)	64 (32)	64 (32)
2.5 M	32 (16)	64 (32)	64 (32)
5 M	16 (8)	64 (32)	64 (32)
10 M	8 (4)	32 (16)	64 (32)
25 M	4 (2)	16 (8)	32 (16)
50 M	2 (1)	8 (4)	16 (8)

The values inside the parentheses are the maximum number of channels in a group. For how to count the number channels, see appendix 1.

In Recorder mode when the time base is an external clock

This is the same as when dual capture is off in SSD recording.

Note

In SSD recording, the sample rate is limited by the number of channels, so depending on the sample rate, the number of channels that can be set may be less than the above maximum number. For details, see appendix 6.

Appendix 5 Maximum Number of History Waveform Acquisitions (Scope mode only)

For details on how to use the appendix, see appendix 1, “Using the Appendix.”

For the number of dual capture waveform acquisitions (high-speed side), see appendix 7.

Standard Model

Number of Channels	Set record length								
	10 k	25 k	50 k	100 k	250 k	500 k	1 M	2.5 M	5 M
Up to 2 (1)	5000	5000	4093	2045	1021	509	253	125	61
Up to 4 (2)	5000	4093	2045	1021	509	253	125	61	31
Up to 8 (4)	4093	2045	1021	509	253	125	61	31	15
Up to 16 (8)	2045	1021	509	253	125	61	31	15	7
Up to 32 (16)	1021	509	253	125	61	31	15	7	3
Up to 64 (32)	509	253	125	61	31	15	7	3	1

Number of Channels	Set record length					
	10 M	25 M	50 M	100 M	250 M	500 M
Up to 2 (1)	31	15	7	3	1	1
Up to 4 (2)	15	7	3	1	1	0
Up to 8 (4)	7	3	1	1	0	0
Up to 16 (8)	3	1	1	0	0	0
Up to 32 (16)	1	1	0	0	0	0
Up to 64 (32)	1	0	0	0	0	0

The values inside the parentheses are the maximum number of channels in a group. For how to count the number channels, see appendix 1.



- : The average of history waveforms can be displayed only when waveforms are acquired in this setting range (when the number of waveforms that can be acquired is 61 or more).
- : Waveforms cannot be acquired in this setting range (when the number of waveforms that can be acquired is 1) and the acquisition mode is set to averaging.
- : Waveforms cannot be acquired in this setting range when the trigger mode is set to Normal or Single N or when the trigger mode is set to Auto or Auto Level and the time scale is set so that roll mode display is not activated.

Memory Expansion 4 Gpoint model (/M1 option)

Number of Channels	Set record length								
	10 k	25 k	50 k	100 k	250 k	500 k	1 M	2.5 M	5 M
Up to 2 (1)	5000	5000	5000	5000	4093	2045	1021	509	253
Up to 4 (2)	5000	5000	5000	4093	2045	1021	509	253	125
Up to 8 (4)	5000	5000	4093	2045	1021	509	253	125	61
Up to 16 (8)	5000	4093	2045	1021	509	253	125	61	31
Up to 32 (16)	4093	2045	1021	509	253	125	61	31	15
Up to 64 (32)	2045	1021	509	253	125	61	31	15	7

Number of Channels	Set record length							
	10 M	25 M	50 M	100 M	250 M	500 M	1 G	2 G
Up to 2 (1)	125	61	31	15	7	3	1	1
Up to 4 (2)	61	31	15	7	3	1	1	0
Up to 8 (4)	31	15	7	3	1	1	0	0
Up to 16 (8)	15	7	3	1	1	0	0	0
Up to 32 (16)	7	3	1	1	0	0	0	0
Up to 64 (32)	3	1	1	0	0	0	0	0

The values inside the parentheses are the maximum number of channels in a group. For how to count the number channels, see appendix 1.



- : The average of history waveforms can be displayed only when waveforms are acquired in this setting range (when the number of waveforms that can be acquired is 61 or more).
- : Waveforms cannot be acquired in this setting range (when the number of waveforms that can be acquired is 1) and the acquisition mode is set to averaging.
- : Waveforms cannot be acquired in this setting range when the trigger mode is set to Normal or Single N or when the trigger mode is set to Auto or Auto Level and the time scale is set so that roll mode display is not activated.

Memory Expansion 8 Gpoint model (/M2 option)

Number of Channels	Set record length								
	10 k	25 k	50 k	100 k	250 k	500 k	1 M	2.5 M	5 M
Up to 2 (1)	5000	5000	5000	5000	5000	4093	2045	1021	509
Up to 4 (2)	5000	5000	5000	5000	4093	2045	1021	509	253
Up to 8 (4)	5000	5000	5000	4093	2045	1021	509	253	125
Up to 16 (8)	5000	5000	4093	2045	1021	509	253	125	61
Up to 32 (16)	5000	4093	2045	1021	509	253	125	61	31
Up to 64 (32)	4093	2045	1021	509	253	125	61	31	15

Number of Channels	Set record length								
	10 M	25 M	50 M	100 M	250 M	500 M	1 G	2 G	4 G
Up to 2 (1)	253	125	61	31	15	7	3	1	1
Up to 4 (2)	125	61	31	15	7	3	1	1	0
Up to 8 (4)	61	31	15	7	3	1	1	0	0
Up to 16 (8)	31	15	7	3	1	1	0	0	0
Up to 32 (16)	15	7	3	1	1	0	0	0	0
Up to 64 (32)	7	3	1	1	0	0	0	0	0

The values inside the parentheses are the maximum number of channels in a group. For how to count the number channels, see appendix 1.

- : The average of history waveforms can be displayed only when waveforms are acquired in this setting range (when the number of waveforms that can be acquired is 61 or more).
- : Waveforms cannot be acquired in this setting range (when the number of waveforms that can be acquired is 1) and the acquisition mode is set to averaging.
- : Waveforms cannot be acquired in this setting range when the trigger mode is set to Normal or Single N or when the trigger mode is set to Auto or Auto Level and the time scale is set so that roll mode display is not activated.

Appendix 6 Maximum Sample Rate for SSD Recording

For details on how to use the appendix, see appendix 1, “Using the Appendix.”

When measurement is performed in SSD recording mode, the sample rate is limited by the number of channels as follows:

Maximum Number of Channels	Maximum Sample Rate
64 channels	50 kS/s
32 channels	100 kS/s
16 channels	200 kS/s
6 channels	500 kS/s
3 channels	1 MS/s
1 channels	2 MS/s

Relation to Appendix 4

In Scope mode, the maximum number of channels that can be measured simultaneously is determined by the record length setting (see appendix 4), but for SSD recording, the maximum sample rate is limited by the maximum number of channels (see above). So depending on the sample rate, the maximum number of channels may be less than the maximum number of channels described in appendix 4.

• Example for SSD Recording, Dual Capture Off, /M2 Option

Set Record Length (Example)	Sample Rate	Maximum Number of Channels for One Group	Maximum Number of Channels for Two Groups
50 Gpoint	2 MS/s	1 ch ¹	1 ch ¹
	1 MS/s	3 ch ¹	3 ch ¹
	500 kS/s	4 ch ²	6 ch ¹
	Slower than 200 kS/s	4 ch ²	8 ch ²

1 Limit by sample rate (appendix 6)

2 Limit of appendix 4 (up to eight channels total for two groups, up to four channels for one group)

Note

In Recorder mode, you do not need to consider the relation to appendix 6 as the above limit is reflected in the table of appendix 8. However, when the time base is an external clock, the highest external clock input frequency that allows SSD recording is the maximum sample rate shown above.

Appendix 7 Dual Capture (High-Speed Sampling) Acquisition Count (Scope mode only)

For details on how to use the appendix, see appendix 1, “Using the Appendix.”

Standard Model

When SSD Is Set to OFF

Number of Channels	Set Record Length (High-Speed Sampling)											
	10 k	25 k	50 k	100 k	250 k	500 k	1 M	2.5 M	5 M	10 M	25 M	50 M
Up to 2 (1)	5000	4095	2047	1023	511	255	127	63	31	15	7	3
Up to 4 (2)	4095	2047	1023	511	255	127	63	31	15	7	3	1
Up to 8 (4)	2047	1023	511	255	127	63	31	15	7	3	1	0
Up to 16 (8)	1023	511	255	127	63	31	15	7	3	1	0	0
Up to 32 (16)	511	255	127	63	31	15	7	3	1	0	0	0
Up to 64 (32)	255	127	63	31	15	7	3	1	0	0	0	0

The values inside the parentheses are the maximum number of channels in a group. For how to count the number channels, see appendix 1.

 This is referenced in “Examples of Using the Appendix” on page App-1.

When SSD Is Set to ON

Number of Channels	Set Record Length (High-Speed Sampling)											
	10 k	25 k	50 k	100 k	250 k	500 k	1 M	2.5 M	5 M	10 M	25 M	50 M
Up to 2 (1)	3583	1791	895	447	223	111	55	27	13	6	2	1
Up to 4 (2)	1791	895	447	223	111	55	27	13	6	2	1	0
Up to 8 (4)	895	447	223	111	55	27	13	6	2	1	0	0
Up to 16 (8)	447	223	111	55	27	13	6	2	1	0	0	0
Up to 32 (16)	223	111	55	27	13	6	2	1	0	0	0	0
Up to 64 (32)	111	55	27	13	6	2	1	0	0	0	0	0

The values inside the parentheses are the maximum number of channels in a group. For how to count the number channels, see appendix 1.

Memory Expansion 4 Gpoint model (/M1 option)

When SSD Is Set to OFF

Number of Channels	Set Record Length (High-Speed Sampling)											
	10 k	25 k	50 k	100 k	250 k	500 k	1 M	2.5 M	5 M	10 M	25 M	50 M
Up to 2 (1)	5000	5000	5000	4095	2047	1023	511	255	127	63	31	15
Up to 4 (2)	5000	5000	4095	2047	1023	511	255	127	63	31	15	7
Up to 8 (4)	5000	4095	2047	1023	511	255	127	63	31	15	7	3
Up to 16 (8)	4095	2047	1023	511	255	127	63	31	15	7	3	1
Up to 32 (16)	2047	1023	511	255	127	63	31	15	7	3	1	0
Up to 64 (32)	1023	511	255	127	63	31	15	7	3	1	0	0

The values inside the parentheses are the maximum number of channels in a group. For how to count the number channels, see appendix 1.

When SSD Is Set to ON

Number of Channels	Set Record Length (High-Speed Sampling)											
	10 k	25 k	50 k	100 k	250 k	500 k	1 M	2.5 M	5 M	10 M	25 M	50 M
Up to 2 (1)	5000	5000	3583	1791	895	447	223	111	55	27	13	6
Up to 4 (2)	5000	3583	1791	895	447	223	111	55	27	13	6	2
Up to 8 (4)	3583	1791	895	447	223	111	55	27	13	6	2	1
Up to 16 (8)	1791	895	447	223	111	55	27	13	6	2	1	0
Up to 32 (16)	895	447	223	111	55	27	13	6	2	1	0	0
Up to 64 (32)	447	223	111	55	27	13	6	2	1	0	0	0

The values inside the parentheses are the maximum number of channels in a group. For how to count the number channels, see appendix 1.

Memory Expansion 8 Gpoint model (/M2 option)

When SSD Is Set to OFF

Number of Channels	Set Record Length (High-Speed Sampling)											
	10 k	25 k	50 k	100 k	250 k	500 k	1 M	2.5 M	5 M	10 M	25 M	50 M
Up to 2 (1)	5000	5000	5000	5000	4095	2047	1023	511	255	127	63	31
Up to 4 (2)	5000	5000	5000	4095	2047	1023	511	255	127	63	31	15
Up to 8 (4)	5000	5000	4095	2047	1023	511	255	127	63	31	15	7
Up to 16 (8)	5000	4095	2047	1023	511	255	127	63	31	15	7	3
Up to 32 (16)	4095	2047	1023	511	255	127	63	31	15	7	3	1
Up to 64 (32)	2047	1023	511	255	127	63	31	15	7	3	1	0

The values inside the parentheses are the maximum number of channels in a group. For how to count the number channels, see appendix 1.

When SSD Is Set to ON

Number of Channels	Set Record Length (High-Speed Sampling)											
	10 k	25 k	50 k	100 k	250 k	500 k	1 M	2.5 M	5 M	10 M	25 M	50 M
Up to 2 (1)	5000	5000	5000	3583	1791	895	447	223	111	55	27	13
Up to 4 (2)	5000	5000	3583	1791	895	447	223	111	55	27	13	6
Up to 8 (4)	5000	3583	1791	895	447	223	111	55	27	13	6	2
Up to 16 (8)	3583	1791	895	447	223	111	55	27	13	6	2	1
Up to 32 (16)	1791	895	447	223	111	55	27	13	6	2	1	0
Up to 64 (32)	895	447	223	111	55	27	13	6	2	1	0	0

The values inside the parentheses are the maximum number of channels in a group. For how to count the number channels, see appendix 1.

Appendix 8 Acquisition/Record Time and Sample Interval (Recorder mode only)

For details on how to use the appendix, see appendix 1, “Using the Appendix.”

Memory Recording

Note

You cannot set the acquisition time with the numeric keypad when the acquisition condition (Acquisition Condition) is set to Continuous or Capture on Trigger during memory recording. In this case, select the acquisition time from the options displayed in the menu.

Standard Model

Acquisition Time Set from the Menu	Number of Channels*					
	Up to 64 (32)	Up to 32 (16)	Up to 16 (8)	Up to 8 (4)	Up to 4 (2)	Up to 2 (1)
1 s	1 ms to 100 ns	1 ms to 100 ns	1 ms to 100 ns	1 ms to 100 ns	1 ms to 100 ns	1 ms to 100 ns
2 s	2 ms to 200 ns	2 ms to 100 ns	2 ms to 100 ns	2 ms to 100 ns	2 ms to 100 ns	2 ms to 100 ns
3 s to 5 s	5 ms to 500 ns	5 ms to 200 ns	5 ms to 100 ns	5 ms to 100 ns	5 ms to 100 ns	5 ms to 100 ns
6 s to 10 s	10 ms to 1 μ s	10 ms to 500 ns	10 ms to 200 ns	10 ms to 100 ns	10 ms to 100 ns	10 ms to 100 ns
11 s to 20 s	20 ms to 2 μ s	20 ms to 1 μ s	20 ms to 500 ns	20 ms to 200 ns	20 ms to 100 ns	20 ms to 100 ns
21 s to 30 s	50 ms to 5 μ s	50 ms to 2 μ s	50 ms to 1 μ s	50 ms to 500 ns	50 ms to 200 ns	50 ms to 100 ns
31 s to 40 s	50 ms to 5 μ s	50 ms to 2 μ s	50 ms to 1 μ s	50 ms to 500 ns	50 ms to 200 ns	50 ms to 100 ns
41 s to 50 s	50 ms to 5 μ s	50 ms to 2 μ s	50 ms to 1 μ s	50 ms to 500 ns	50 ms to 200 ns	50 ms to 100 ns
51 s to 60 s	100 ms to 10 μ s	100 ms to 5 μ s	100 ms to 2 μ s	100 ms to 1 μ s	100 ms to 500 ns	100 ms to 200 ns
61 s to 100 s (1 min40 s)	100 ms to 10 μ s	100 ms to 5 μ s	100 ms to 2 μ s	100 ms to 1 μ s	100 ms to 500 ns	100 ms to 200 ns
101 s (1 min41 s) to 200 s (3 min20 s)	200 ms to 20 μ s	200 ms to 10 μ s	200 ms to 5 μ s	200 ms to 2 μ s	200 ms to 1 μ s	200 ms to 500 ns
201 s (3 min21 s) to 300 s (5 min)	200 ms to 50 μ s	200 ms to 20 μ s	200 ms to 10 μ s	200 ms to 5 μ s	200 ms to 2 μ s	200 ms to 1 μ s
301 s (5 min1 s) to 600 s (10 min)	200 ms to 100 μ s	200 ms to 50 μ s	200 ms to 20 μ s	200 ms to 10 μ s	200 ms to 5 μ s	200 ms to 2 μ s
10 min1 s to 20 min	200 ms to 200 μ s	200 ms to 50 μ s	200 ms to 50 μ s	200 ms to 20 μ s	200 ms to 5 μ s	200 ms to 5 μ s
20 min1 s to 30 min	200 ms to 200 μ s	200 ms to 100 μ s	200 ms to 50 μ s	200 ms to 20 μ s	200 ms to 10 μ s	200 ms to 5 μ s
30 min1 s to 40 min	100 ms to 500 μ s	100 ms to 100 μ s	100 ms to 50 μ s	100 ms to 50 μ s	100 ms to 10 μ s	100 ms to 5 μ s
40 min1 s to 50 min	200 ms to 500 μ s	200 ms to 200 μ s	200 ms to 100 μ s	200 ms to 50 μ s	200 ms to 20 μ s	200 ms to 10 μ s
50 min1 s to 60 min	200 ms to 500 μ s	200 ms to 200 μ s	200 ms to 100 μ s	200 ms to 50 μ s	200 ms to 20 μ s	200 ms to 10 μ s
61 min to 100 min	200 ms to 1 ms	200 ms to 500 μ s	200 ms to 200 μ s	200 ms to 100 μ s	200 ms to 50 μ s	200 ms to 20 μ s
101 min (1 hour41 min) to 120 min (2 hour)	200 ms to 1 ms	200 ms to 500 μ s	200 ms to 200 μ s	200 ms to 100 μ s	200 ms to 50 μ s	200 ms to 20 μ s
121 min (2 hour1 min) to 300 min (5 hour)	200 ms to 2 ms	200 ms to 1 ms	200 ms to 500 μ s	200 ms to 200 μ s	200 ms to 100 μ s	200 ms to 50 μ s
301 min (5 hour1 min) to 10 hour	200 ms to 5 ms	200 ms to 2 ms	200 ms to 1 ms	200 ms to 500 μ s	200 ms to 200 μ s	200 ms to 100 μ s
10 hour1 min to 20 hour	100 ms to 10 ms	100 ms to 5 ms	100 ms to 2 ms	100 ms to 1 ms	100 ms to 500 μ s	100 ms to 200 μ s
20 hour1 min to 30 hour (1 day6 hour)	200 ms to 20 ms	200 ms to 5 ms	200 ms to 5 ms	200 ms to 2 ms	200 ms to 500 μ s	200 ms to 500 μ s
31 hour (1 day7 hour) to 40 hour (1 day16 hour)	200 ms to 20 ms	200 ms to 10 ms	200 ms to 5 ms	200 ms to 2 ms	200 ms to 1 ms	200 ms to 500 μ s
41 hour (1 day17 hour) to 50 hour (2 day2 hour)	200 ms to 20 ms	200 ms to 10 ms	200 ms to 5 ms	200 ms to 2 ms	200 ms to 1 ms	200 ms to 500 μ s
51 hour (2 day3 hour) to 60 hour (2 day12 hour)	200 ms to 50 ms	200 ms to 10 ms	200 ms to 5 ms	200 ms to 5 ms	200 ms to 1 ms	200 ms to 500 μ s
61 hour (2 day13 hour) to 80 hour (3 day8 hour)	200 ms to 50 ms	200 ms to 20 ms	200 ms to 10 ms	200 ms to 5 ms	200 ms to 2 ms	200 ms to 1 ms
81 hour (3 day9 hour) to 100 hour (4 day4 hour)	200 ms to 50 ms	200 ms to 20 ms	200 ms to 10 ms	200 ms to 5 ms	200 ms to 2 ms	200 ms to 1 ms
101 hour (4 day5 hour) to 120 hour (5 day)	200 ms to 50 ms	200 ms to 20 ms	200 ms to 10 ms	200 ms to 5 ms	200 ms to 2 ms	200 ms to 1 ms
121 hour (5 day1 hour) to 10 day	200 ms to 100 ms	200 ms to 50 ms	200 ms to 20 ms	200 ms to 10 ms	200 ms to 5 ms	200 ms to 2 ms

Appendix 8 Acquisition/Record Time and Sample Interval (Recorder mode only)

Acquisition Time Set from the Menu	Number of Channels*					
	Up to 64 (32)	Up to 32 (16)	Up to 16 (8)	Up to 8 (4)	Up to 4 (2)	Up to 2 (1)
10 day1 hour to 20 day	200 ms	200 ms to 100 ms	200 ms to 50 ms	200 ms to 20 ms	200 ms to 10 ms	200 ms to 5 ms
20 day1 hour to 30 day	-	200 ms	200 ms to 100 ms	200 ms to 50 ms	200 ms to 20 ms	200 ms to 10 ms
30 day1 hour to 40 day	-	200 ms	200 ms to 100 ms	200 ms to 50 ms	200 ms to 20 ms	200 ms to 10 ms
40 day1 hour to 50 day	-	200 ms	200 ms to 100 ms	200 ms to 50 ms	200 ms to 20 ms	200 ms to 10 ms

* The values inside the parentheses are the maximum number of channels in a group. For how to count the number channels, see appendix 1.

Memory Expansion 4 Gpoint model (/M1 option)

Acquisition Time Set from the Menu	Number of Channels*					
	Up to 64 (32)	Up to 32 (16)	Up to 16 (8)	Up to 8 (4)	Up to 4 (2)	Up to 2 (1)
1 s	1 ms to 100 ns	1 ms to 100 ns	1 ms to 100 ns	1 ms to 100 ns	1 ms to 100 ns	1 ms to 100 ns
2 s	2 ms to 100 ns	2 ms to 100 ns	2 ms to 100 ns	2 ms to 100 ns	2 ms to 100 ns	2 ms to 100 ns
3 s to 5 s	5 ms to 100 ns	5 ms to 100 ns	5 ms to 100 ns	5 ms to 100 ns	5 ms to 100 ns	5 ms to 100 ns
6 s to 10 s	10 ms to 200 ns	10 ms to 100 ns	10 ms to 100 ns	10 ms to 100 ns	10 ms to 100 ns	10 ms to 100 ns
11 s to 20 s	20 ms to 500 ns	20 ms to 200 ns	20 ms to 100 ns	20 ms to 100 ns	20 ms to 100 ns	20 ms to 100 ns
21 s to 30 s	50 ms to 1 µs	50 ms to 500 ns	50 ms to 200 ns	50 ms to 100 ns	50 ms to 100 ns	50 ms to 100 ns
31 s to 40 s	50 ms to 1 µs	50 ms to 500 ns	50 ms to 200 ns	50 ms to 100 ns	50 ms to 100 ns	50 ms to 100 ns
41 s to 50 s	50 ms to 1 µs	50 ms to 500 ns	50 ms to 200 ns	50 ms to 100 ns	50 ms to 100 ns	50 ms to 100 ns
51 s to 60 s	100 ms to 2 µs	100 ms to 1 µs	100 ms to 500 ns	100 ms to 200 ns	100 ms to 100 ns	100 ms to 100 ns
61 s to 100 s (1 min40 s)	100 ms to 2 µs	100 ms to 1 µs	100 ms to 500 ns	100 ms to 200 ns	100 ms to 100 ns	100 ms to 100 ns
101 s (1 min41 s) to 200 s (3 min20 s)	200 ms to 5 µs	200 ms to 2 µs	200 ms to 1 µs	200 ms to 500 ns	200 ms to 200 ns	200 ms to 100 ns
201 s (3 min21 s) to 300 s (5 min)	200 ms to 10 µs	200 ms to 5 µs	200 ms to 2 µs	200 ms to 1 µs	200 ms to 500 ns	200 ms to 200 ns
301 s (5 min1 s) to 600 s (10 min)	200 ms to 20 µs	200 ms to 10 µs	200 ms to 5 µs	200 ms to 2 µs	200 ms to 1 µs	200 ms to 500 ns
10 min1 s to 20 min	200 ms to 50 µs	200 ms to 20 µs	200 ms to 5 µs	200 ms to 5 µs	200 ms to 2 µs	200 ms to 1 µs
20 min1 s to 30 min	200 ms to 50 µs	200 ms to 20 µs	200 ms to 10 µs	200 ms to 5 µs	200 ms to 2 µs	200 ms to 1 µs
30 min1 s to 40 min	100 ms to 50 µs	100 ms to 50 µs	100 ms to 10 µs	100 ms to 5 µs	100 ms to 5 µs	100 ms to 2 µs
40 min1 s to 50 min	200 ms to 100 µs	200 ms to 50 µs	200 ms to 20 µs	200 ms to 10 µs	200 ms to 5 µs	200 ms to 2 µs
50 min1 s to 60 min	200 ms to 100 µs	200 ms to 50 µs	200 ms to 20 µs	200 ms to 10 µs	200 ms to 5 µs	200 ms to 2 µs
61 min to 100 min	200 ms to 200 µs	200 ms to 100 µs	200 ms to 50 µs	200 ms to 20 µs	200 ms to 10 µs	200 ms to 5 µs
101 min (1 hour41 min) to 120 min (2 hour)	200 ms to 200 µs	200 ms to 100 µs	200 ms to 50 µs	200 ms to 20 µs	200 ms to 10 µs	200 ms to 5 µs
121 min (2 hour1 min) to 300 min (5 hour)	200 ms to 500 µs	200 ms to 200 µs	200 ms to 100 µs	200 ms to 50 µs	200 ms to 20 µs	200 ms to 10 µs
301 min (5 hour1 min) to 10 hour	200 ms to 1 ms	200 ms to 500 µs	200 ms to 200 µs	200 ms to 100 µs	200 ms to 50 µs	200 ms to 20 µs
10 hour1 min to 20 hour	100 ms to 2 ms	100 ms to 1 ms	100 ms to 500 µs	100 ms to 200 µs	100 ms to 100 µs	100 ms to 50 µs
20 hour1 min to 30 hour (1 day6 hour)	200 ms to 5 ms	200 ms to 2 ms	200 ms to 500 µs	200 ms to 500 µs	200 ms to 200 µs	200 ms to 100 µs
31 hour (1 day7 hour) to 40 hour (1 day16 hour)	200 ms to 5 ms	200 ms to 2 ms	200 ms to 1 ms	200 ms to 500 µs	200 ms to 200 µs	200 ms to 100 µs
41 hour (1 day17 hour) to 50 hour (2 day2 hour)	200 ms to 5 ms	200 ms to 2 ms	200 ms to 1 ms	200 ms to 500 µs	200 ms to 200 µs	200 ms to 100 µs
51 hour (2 day3 hour) to 60 hour (2 day12 hour)	200 ms to 5 ms	200 ms to 5 ms	200 ms to 1 ms	200 ms to 500 µs	200 ms to 500 µs	200 ms to 200 µs
61 hour (2 day13 hour) to 80 hour (3 day8 hour)	200 ms to 10 ms	200 ms to 5 ms	200 ms to 2 ms	200 ms to 1 ms	200 ms to 500 µs	200 ms to 200 µs
81 hour (3 day9 hour) to 100 hour (4 day4 hour)	200 ms to 10 ms	200 ms to 5 ms	200 ms to 2 ms	200 ms to 1 ms	200 ms to 500 µs	200 ms to 200 µs
101 hour (4 day5 hour) to 120 hour (5 day)	200 ms to 10 ms	200 ms to 5 ms	200 ms to 2 ms	200 ms to 1 ms	200 ms to 500 µs	200 ms to 500 µs
121 hour (5 day1 hour) to 10 day	200 ms to 20 ms	200 ms to 10 ms	200 ms to 5 ms	200 ms to 2 ms	200 ms to 1 ms	200 ms to 500 µs
10 day1 hour to 20 day	200 ms to 50 ms	200 ms to 20 ms	200 ms to 10 ms	200 ms to 5 ms	200 ms to 2 ms	200 ms to 1 ms
20 day1 hour to 30 day	200 ms to 100 ms	200 ms to 50 ms	200 ms to 20 ms	200 ms to 10 ms	200 ms to 5 ms	200 ms to 2 ms

Appendix 8 Acquisition/Record Time and Sample Interval (Recorder mode only)

Acquisition Time Set from the Menu	Number of Channels*					
	Up to 64 (32)	Up to 32 (16)	Up to 16 (8)	Up to 8 (4)	Up to 4 (2)	Up to 2 (1)
30 day1 hour to 40 day	200 ms to 100 ms	200 ms to 50 ms	200 ms to 20 ms	200 ms to 10 ms	200 ms to 5 ms	200 ms to 2 ms
40 day1 hour to 50 day	200 ms to 100 ms	200 ms to 50 ms	200 ms to 20 ms	200 ms to 10 ms	200 ms to 5 ms	200 ms to 5 ms

* The values inside the parentheses are the maximum number of channels in a group. For how to count the number channels, see appendix 1.

Memory Expansion 8 Gpoint model (/M2 option)

Acquisition Time Set from the Menu	Number of Channels*					
	Up to 64 (32)	Up to 32 (16)	Up to 16 (8)	Up to 8 (4)	Up to 4 (2)	Up to 2 (1)
1 s	1 ms to 100 ns	1 ms to 100 ns	1 ms to 100 ns	1 ms to 100 ns	1 ms to 100 ns	1 ms to 100 ns
2 s	2 ms to 100 ns	2 ms to 100 ns	2 ms to 100 ns	2 ms to 100 ns	2 ms to 100 ns	2 ms to 100 ns
3 s to 5 s	5 ms to 100 ns	5 ms to 100 ns	5 ms to 100 ns	5 ms to 100 ns	5 ms to 100 ns	5 ms to 100 ns
6 s to 10 s	10 ms to 100 ns	10 ms to 100 ns	10 ms to 100 ns	10 ms to 100 ns	10 ms to 100 ns	10 ms to 100 ns
11 s to 20 s	20 ms to 200 ns	20 ms to 100 ns	20 ms to 100 ns	20 ms to 100 ns	20 ms to 100 ns	20 ms to 100 ns
21 s to 30 s	50 ms to 500 ns	50 ms to 200 ns	50 ms to 100 ns	50 ms to 100 ns	50 ms to 100 ns	50 ms to 100 ns
31 s to 40 s	50 ms to 500 ns	50 ms to 200 ns	50 ms to 100 ns	50 ms to 100 ns	50 ms to 100 ns	50 ms to 100 ns
41 s to 50 s	50 ms to 500 ns	50 ms to 200 ns	50 ms to 100 ns	50 ms to 100 ns	50 ms to 100 ns	50 ms to 100 ns
51 s to 60 s	100 ms to 1 µs	100 ms to 500 ns	100 ms to 200 ns	100 ms to 100 ns	100 ms to 100 ns	100 ms to 100 ns
61 s to 100 s (1 min40 s)	100 ms to 1 µs	100 ms to 500 ns	100 ms to 200 ns	100 ms to 100 ns	100 ms to 100 ns	100 ms to 100 ns
101 s (1 min41 s) to 200 s (3 min20 s)	200 ms to 2 µs	200 ms to 1 µs	200 ms to 500 ns	200 ms to 200 ns	200 ms to 100 ns	200 ms to 100 ns
201 s (3 min21 s) to 300 s (5 min)	200 ms to 5 µs	200 ms to 2 µs	200 ms to 1 µs	200 ms to 500 ns	200 ms to 200 ns	200 ms to 100 ns
301 s (5 min1 s) to 600 s (10 min)	200 ms to 10 µs	200 ms to 5 µs	200 ms to 2 µs	200 ms to 1 µs	200 ms to 500 ns	200 ms to 200 ns
10 min1 s to 20 min	200 ms to 20 µs	200 ms to 5 µs	200 ms to 5 µs	200 ms to 2 µs	200 ms to 1 µs	200 ms to 500 ns
20 min1 s to 30 min	200 ms to 20 µs	200 ms to 10 µs	200 ms to 5 µs	200 ms to 2 µs	200 ms to 1 µs	200 ms to 500 ns
30 min1 s to 40 min	100 ms to 50 µs	100 ms to 10 µs	100 ms to 5 µs	100 ms to 5 µs	100 ms to 2 µs	100 ms to 1 µs
40 min1 s to 50 min	200 ms to 50 µs	200 ms to 20 µs	200 ms to 10 µs	200 ms to 5 µs	200 ms to 2 µs	200 ms to 1 µs
50 min1 s to 60 min	200 ms to 50 µs	200 ms to 20 µs	200 ms to 10 µs	200 ms to 5 µs	200 ms to 2 µs	200 ms to 1 µs
61 min to 100 min	200 ms to 100 µs	200 ms to 50 µs	200 ms to 20 µs	200 ms to 10 µs	200 ms to 5 µs	200 ms to 2 µs
101 min (1 hour41 min) to 120 min (2 hour)	200 ms to 100 µs	200 ms to 50 µs	200 ms to 20 µs	200 ms to 10 µs	200 ms to 5 µs	200 ms to 2 µs
121 min (2 hour1 min) to 300 min (5 hour)	200 ms to 200 µs	200 ms to 100 µs	200 ms to 50 µs	200 ms to 20 µs	200 ms to 10 µs	200 ms to 5 µs
301 min (5 hour1 min) to 10 hour	200 ms to 500 µs	200 ms to 200 µs	200 ms to 100 µs	200 ms to 50 µs	200 ms to 20 µs	200 ms to 10 µs
10 hour1 min to 20 hour	100 ms to 1 ms	100 ms to 500 µs	100 ms to 200 µs	100 ms to 100 µs	100 ms to 50 µs	100 ms to 20 µs
20 hour1 min to 30 hour (1 day6 hour)	200 ms to 2 ms	200 ms to 500 µs	200 ms to 500 µs	200 ms to 200 µs	200 ms to 100 µs	200 ms to 50 µs
31 hour (1 day7 hour) to 40 hour (1 day16 hour)	200 ms to 2 ms	200 ms to 1 ms	200 ms to 500 µs	200 ms to 200 µs	200 ms to 100 µs	200 ms to 50 µs
41 hour (1 day17 hour) to 50 hour (2 day2 hour)	200 ms to 2 ms	200 ms to 1 ms	200 ms to 500 µs	200 ms to 200 µs	200 ms to 100 µs	200 ms to 50 µs
51 hour (2 day3 hour) to 60 hour (2 day12 hour)	200 ms to 5 ms	200 ms to 1 ms	200 ms to 500 µs	200 ms to 500 µs	200 ms to 200 µs	200 ms to 100 µs
61 hour (2 day13 hour) to 80 hour (3 day8 hour)	200 ms to 5 ms	200 ms to 2 ms	200 ms to 1 ms	200 ms to 500 µs	200 ms to 200 µs	200 ms to 100 µs
81 hour (3 day9 hour) to 100 hour (4 day4 hour)	200 ms to 5 ms	200 ms to 2 ms	200 ms to 1 ms	200 ms to 500 µs	200 ms to 200 µs	200 ms to 100 µs
101 hour (4 day5 hour) to 120 hour (5 day)	200 ms to 5 ms	200 ms to 2 ms	200 ms to 1 ms	200 ms to 500 µs	200 ms to 500 µs	200 ms to 200 µs
121 hour (5 day1 hour) to 10 day	200 ms to 10 ms	200 ms to 5 ms	200 ms to 2 ms	200 ms to 1 ms	200 ms to 500 µs	200 ms to 500 µs
10 day1 hour to 20 day	200 ms to 20 ms	200 ms to 10 ms	200 ms to 5 ms	200 ms to 2 ms	200 ms to 1 ms	200 ms to 500 µs
20 day1 hour to 30 day	200 ms to 50 ms	200 ms to 20 ms	200 ms to 10 ms	200 ms to 5 ms	200 ms to 2 ms	200 ms to 1 ms
30 day1 hour to 40 day	200 ms to 50 ms	200 ms to 20 ms	200 ms to 10 ms	200 ms to 5 ms	200 ms to 2 ms	200 ms to 1 ms
40 day1 hour to 50 day	200 ms to 50 ms	200 ms to 20 ms	200 ms to 10 ms	200 ms to 5 ms	200 ms to 5 ms	200 ms to 2 ms

* The values inside the parentheses are the maximum number of channels in a group. For how to count the number channels, see appendix 1.

SSD Recording

Standard Model

Acquisition Time Set from the Menu	Number of Channels*						
	Up to 64 (32)	Up to 32 (16)	Up to 16 (8)	Up to 8 (4)	Up to 4 (2)	Up to 2 (1)	Up to 1
1 s	1 ms to 20 μ s	1 ms to 10 μ s	1 ms to 5 μ s	1 ms to 5 μ s	1 ms to 2 μ s	1 ms to 1 μ s	1 ms to 500 ns
2 s	2 ms to 20 μ s	2 ms to 10 μ s	2 ms to 5 μ s	2 ms to 5 μ s	2 ms to 2 μ s	2 ms to 1 μ s	2 ms to 500 ns
3 s to 5 s	5 ms to 20 μ s	5 ms to 10 μ s	5 ms to 5 μ s	5 ms to 5 μ s	5 ms to 2 μ s	5 ms to 1 μ s	1 ms to 500 ns
6 s to 10 s	10 ms to 20 μ s	10 ms to 10 μ s	10 ms to 5 μ s	10 ms to 5 μ s	10 ms to 2 μ s	10 ms to 1 μ s	10 ms to 500 ns
11 s to 20 s	20 ms to 20 μ s	20 ms to 10 μ s	20 ms to 5 μ s	20 ms to 5 μ s	20 ms to 2 μ s	20 ms to 1 μ s	20 ms to 500 ns
21 s to 30 s	50 ms to 20 μ s	50 ms to 10 μ s	50 ms to 5 μ s	50 ms to 5 μ s	50 ms to 2 μ s	50 ms to 1 μ s	50 ms to 500 ns
31 s to 40 s	50 ms to 20 μ s	50 ms to 10 μ s	50 ms to 5 μ s	50 ms to 5 μ s	50 ms to 2 μ s	50 ms to 1 μ s	50 ms to 500 ns
41 s to 50 s	50 ms to 20 μ s	50 ms to 10 μ s	50 ms to 5 μ s	50 ms to 5 μ s	50 ms to 2 μ s	50 ms to 1 μ s	50 ms to 500 ns
51 s to 60 s	100 ms to 20 μ s	100 ms to 10 μ s	100 ms to 5 μ s	100 ms to 5 μ s	100 ms to 2 μ s	100 ms to 1 μ s	100 ms to 500 ns
61 s to 100 s (1 min40 s)	100 ms to 20 μ s	100 ms to 10 μ s	100 ms to 5 μ s	100 ms to 5 μ s	100 ms to 2 μ s	100 ms to 1 μ s	100 ms to 500 ns
101 s (1 min41 s) to 200 s (3 min20 s)	200 ms to 20 μ s	200 ms to 10 μ s	200 ms to 5 μ s	200 ms to 5 μ s	200 ms to 2 μ s	200 ms to 1 μ s	200 ms to 500 ns
201 s (3 min21 s) to 300 s (5 min)	200 ms to 20 μ s	200 ms to 10 μ s	200 ms to 5 μ s	200 ms to 5 μ s	200 ms to 2 μ s	200 ms to 1 μ s	200 ms to 500 ns
301 s (5 min1 s) to 600 s (10 min)	200 ms to 20 μ s	200 ms to 10 μ s	200 ms to 5 μ s	200 ms to 5 μ s	200 ms to 2 μ s	200 ms to 1 μ s	200 ms to 500 ns
10 min1 s to 20 min	200 ms to 20 μ s	200 ms to 10 μ s	200 ms to 5 μ s	200 ms to 5 μ s	200 ms to 2 μ s	200 ms to 1 μ s	200 ms to 500 ns
20 min1 s to 30 min	200 ms to 20 μ s	200 ms to 10 μ s	200 ms to 5 μ s	200 ms to 5 μ s	200 ms to 2 μ s	200 ms to 1 μ s	200 ms to 500 ns
30 min1 s to 40 min	100 ms to 20 μ s	100 ms to 10 μ s	100 ms to 5 μ s	100 ms to 5 μ s	100 ms to 2 μ s	100 ms to 1 μ s	200 ms to 500 ns
40 min1 s to 50 min	200 ms to 20 μ s	200 ms to 10 μ s	200 ms to 5 μ s	200 ms to 5 μ s	200 ms to 2 μ s	200 ms to 1 μ s	200 ms to 500 ns
50 min1 s to 60 min	200 ms to 20 μ s	200 ms to 10 μ s	200 ms to 5 μ s	200 ms to 5 μ s	200 ms to 2 μ s	200 ms to 1 μ s	200 ms to 500 ns
61 min to 100 min	200 ms to 20 μ s	200 ms to 10 μ s	200 ms to 5 μ s	200 ms to 5 μ s	200 ms to 2 μ s	200 ms to 1 μ s	200 ms to 500 ns
101 min (1 hour41 min) to 120 min (2 hour)	200 ms to 20 μ s	200 ms to 10 μ s	200 ms to 5 μ s	200 ms to 5 μ s	200 ms to 2 μ s	200 ms to 1 μ s	200 ms to 1 μ s
121 min (2 hour1 min) to 300 min (5 hour)	200 ms to 50 μ s	200 ms to 20 μ s	200 ms to 10 μ s	200 ms to 5 μ s	200 ms to 2 μ s	200 ms to 1 μ s	200 ms to 1 μ s
301 min (5 hour1 min) to 10 hour	200 ms to 100 μ s	200 ms to 50 μ s	200 ms to 20 μ s	200 ms to 10 μ s	200 ms to 5 μ s	200 ms to 2 μ s	200 ms to 2 μ s
10 hour1 min to 20 hour	100 ms to 200 μ s	100 ms to 100 μ s	100 ms to 50 μ s	100 ms to 20 μ s	100 ms to 10 μ s	100 ms to 5 μ s	100 ms to 5 μ s
20 hour1 min to 30 hour (1 day6 hour)	200 ms to 500 μ s	200 ms to 200 μ s	200 ms to 100 μ s	200 ms to 50 μ s	200 ms to 20 μ s	200 ms to 10 μ s	200 ms to 10 μ s
31 hour (1 day7 hour) to 40 hour (1 day16 hour)	200 ms to 500 μ s	200 ms to 200 μ s	200 ms to 100 μ s	200 ms to 50 μ s	200 ms to 20 μ s	200 ms to 10 μ s	200 ms to 10 μ s
41 hour (1 day17 hour) to 50 hour (2 day2 hour)	200 ms to 500 μ s	200 ms to 200 μ s	200 ms to 100 μ s	200 ms to 50 μ s	200 ms to 20 μ s	200 ms to 10 μ s	200 ms to 10 μ s
51 hour (2 day3 hour) to 60 hour (2 day12 hour)	200 ms to 500 μ s	200 ms to 500 μ s	200 ms to 200 μ s	200 ms to 50 μ s	200 ms to 50 μ s	200 ms to 20 μ s	200 ms to 20 μ s
61 hour (2 day13 hour) to 80 hour (3 day8 hour)	200 ms to 1 ms	200 ms to 500 μ s	200 ms to 200 μ s	200 ms to 100 μ s	200 ms to 50 μ s	200 ms to 20 μ s	200 ms to 20 μ s

Appendix 8 Acquisition/Record Time and Sample Interval (Recorder mode only)

Acquisition Time Set from the Menu	Number of Channels*						
	Up to 64 (32)	Up to 32 (16)	Up to 16 (8)	Up to 8 (4)	Up to 4 (2)	Up to 2 (1)	Up to 1
81 hour (3 day9 hour) to 100 hour (4 day4 hour)	200 ms to 1 ms	200 ms to 500 μ s	200 ms to 200 μ s	200 ms to 100 μ s	200 ms to 50 μ s	200 ms to 20 μ s	200 ms to 20 μ s
101 hour (4 day5 hour) to 120 hour (5 day)	200 ms to 1 ms	200 ms to 500 μ s	200 ms to 500 μ s	200 ms to 100 μ s	200 ms to 100 μ s	200 ms to 50 μ s	200 ms to 50 μ s
121 hour (5 day1 hour) to 10 day	200 ms to 2 ms	200 ms to 1 ms	200 ms to 500 μ s	200 ms to 200 μ s	200 ms to 200 μ s	200 ms to 50 μ s	200 ms to 50 μ s
10 day1 hour to 20 day	200 ms to 5 ms	200 ms to 2 ms	200 ms to 1 ms	200 ms to 500 μ s	200 ms to 200 μ s	200 ms to 100 μ s	200 ms to 100 μ s
20 day1 hour to 30 day	200 ms to 10 ms	200 ms to 5 ms	200 ms to 2 ms	200 ms to 1 ms	200 ms to 500 μ s	200 ms to 200 μ s	200 ms to 200 μ s
30 day1 hour to 40 day	200 ms to 10 ms	200 ms to 5 ms	200 ms to 2 ms	200 ms to 1 ms	200 ms to 500 μ s	200 ms to 200 μ s	200 ms to 200 μ s
40 day1 hour to 50 day	200 ms to 10 ms	200 ms to 5 ms	200 ms to 5 ms	200 ms to 1 ms	200 ms to 500 μ s	200 ms to 500 μ s	200 ms to 500 μ s

* The values inside the parentheses are the maximum number of channels in a group. For how to count the number channels, see appendix 1.

Memory Expansion 4 Gpoint model (/M1 option)

Acquisition Time Set from the Menu	Number of Channels*						
	Up to 64 (32)	Up to 32 (16)	Up to 16 (8)	Up to 8 (4)	Up to 4 (2)	Up to 2 (1)	Up to 1
1 s	1 ms to 20 μ s	1 ms to 10 μ s	1 ms to 5 μ s	1 ms to 5 μ s	1 ms to 2 μ s	1 ms to 1 μ s	1 ms to 500 ns
2 s	2 ms to 20 μ s	2 ms to 10 μ s	2 ms to 5 μ s	2 ms to 5 μ s	2 ms to 2 μ s	2 ms to 1 μ s	2 ms to 500 ns
3 s to 5 s	5 ms to 20 μ s	5 ms to 10 μ s	5 ms to 5 μ s	5 ms to 5 μ s	5 ms to 2 μ s	5 ms to 1 μ s	5 ms to 500 ns
6 s to 10 s	10 ms to 20 μ s	10 ms to 10 μ s	10 ms to 5 μ s	10 ms to 5 μ s	10 ms to 2 μ s	10 ms to 1 μ s	10 ms to 500 ns
11 s to 20 s	20 ms to 20 μ s	20 ms to 10 μ s	20 ms to 5 μ s	20 ms to 5 μ s	20 ms to 2 μ s	20 ms to 1 μ s	20 ms to 500 ns
21 s to 30 s	50 ms to 20 μ s	50 ms to 10 μ s	50 ms to 5 μ s	50 ms to 5 μ s	50 ms to 2 μ s	50 ms to 1 μ s	50 ms to 500 ns
31 s to 40 s	50 ms to 20 μ s	50 ms to 10 μ s	50 ms to 5 μ s	50 ms to 5 μ s	50 ms to 2 μ s	50 ms to 1 μ s	50 ms to 500 ns
41 s to 50 s	50 ms to 20 μ s	50 ms to 10 μ s	50 ms to 5 μ s	50 ms to 5 μ s	50 ms to 2 μ s	50 ms to 1 μ s	50 ms to 500 ns
51 s to 60 s	100 ms to 20 μ s	100 ms to 10 μ s	100 ms to 5 μ s	100 ms to 5 μ s	100 ms to 2 μ s	100 ms to 1 μ s	100 ms to 500 ns
61 s to 100 s (1 min40 s)	100 ms to 20 μ s	100 ms to 10 μ s	100 ms to 5 μ s	100 ms to 5 μ s	100 ms to 2 μ s	100 ms to 1 μ s	100 ms to 500 ns
101 s (1 min41 s) to 200 s (3 min20 s)	200 ms to 20 μ s	200 ms to 10 μ s	200 ms to 5 μ s	200 ms to 5 μ s	200 ms to 2 μ s	200 ms to 1 μ s	200 ms to 500 ns
201 s (3 min21 s) to 300 s (5 min)	200 ms to 20 μ s	200 ms to 10 μ s	200 ms to 5 μ s	200 ms to 5 μ s	200 ms to 2 μ s	200 ms to 1 μ s	200 ms to 500 ns
301 s (5 min1 s) to 600 s (10 min)	200 ms to 20 μ s	200 ms to 10 μ s	200 ms to 5 μ s	200 ms to 5 μ s	200 ms to 2 μ s	200 ms to 1 μ s	200 ms to 500 ns
10 min1 s to 20 min	200 ms to 20 μ s	200 ms to 10 μ s	200 ms to 5 μ s	200 ms to 5 μ s	200 ms to 2 μ s	200 ms to 1 μ s	200 ms to 500 ns
20 min1 s to 30 min	200 ms to 20 μ s	200 ms to 10 μ s	200 ms to 5 μ s	200 ms to 5 μ s	200 ms to 2 μ s	200 ms to 1 μ s	200 ms to 500 ns
30 min1 s to 40 min	100 ms to 20 μ s	100 ms to 10 μ s	100 ms to 5 μ s	100 ms to 5 μ s	100 ms to 2 μ s	100 ms to 1 μ s	200 ms to 500 ns
40 min1 s to 50 min	200 ms to 20 μ s	200 ms to 10 μ s	200 ms to 5 μ s	200 ms to 5 μ s	200 ms to 2 μ s	200 ms to 1 μ s	200 ms to 500 ns
50 min1 s to 60 min	200 ms to 20 μ s	200 ms to 10 μ s	200 ms to 5 μ s	200 ms to 5 μ s	200 ms to 2 μ s	200 ms to 1 μ s	200 ms to 500 ns
61 min to 100 min	200 ms to 20 μ s	200 ms to 10 μ s	200 ms to 5 μ s	200 ms to 5 μ s	200 ms to 2 μ s	200 ms to 1 μ s	200 ms to 500 ns
101 min (1 hour41 min) to 120 min (2 hour)	200 ms to 20 μ s	200 ms to 10 μ s	200 ms to 5 μ s	200 ms to 5 μ s	200 ms to 2 μ s	200 ms to 1 μ s	200 ms to 500 ns
121 min (2 hour1 min) to 300 min (5 hour)	200 ms to 20 μ s	200 ms to 10 μ s	200 ms to 5 μ s	200 ms to 5 μ s	200 ms to 2 μ s	200 ms to 1 μ s	200 ms to 500 ns
301 min (5 hour1 min) to 10 hour	200 ms to 20 μ s	200 ms to 10 μ s	200 ms to 5 μ s	200 ms to 5 μ s	200 ms to 2 μ s	200 ms to 1 μ s	200 ms to 1 μ s

Appendix 8 Acquisition/Record Time and Sample Interval (Recorder mode only)

Acquisition Time Set from the Menu	Number of Channels*						
	Up to 64 (32)	Up to 32 (16)	Up to 16 (8)	Up to 8 (4)	Up to 4 (2)	Up to 2 (1)	Up to 1
10 hour 1 min to 20 hour	100 ms to 50 μ s	100 ms to 20 μ s	100 ms to 10 μ s	100 ms to 5 μ s	100 ms to 2 μ s	100 ms to 2 μ s	100 ms to 2 μ s
20 hour 1 min to 30 hour (1 day 6 hour)	200 ms to 100 μ s	200 ms to 50 μ s	200 ms to 20 μ s	200 ms to 10 μ s	200 ms to 5 μ s	200 ms to 5 μ s	200 ms to 5 μ s
31 hour (1 day 7 hour) to 40 hour (1 day 16 hour)	200 ms to 100 μ s	200 ms to 50 μ s	200 ms to 20 μ s	200 ms to 10 μ s	200 ms to 5 μ s	200 ms to 5 μ s	200 ms to 5 μ s
41 hour (1 day 17 hour) to 50 hour (2 day 2 hour)	200 ms to 100 μ s	200 ms to 50 μ s	200 ms to 20 μ s	200 ms to 10 μ s	200 ms to 5 μ s	200 ms to 5 μ s	200 ms to 5 μ s
51 hour (2 day 3 hour) to 60 hour (2 day 12 hour)	200 ms to 200 μ s	200 ms to 50 μ s	200 ms to 50 μ s	200 ms to 20 μ s	200 ms to 5 μ s	200 ms to 5 μ s	200 ms to 5 μ s
61 hour (2 day 13 hour) to 80 hour (3 day 8 hour)	200 ms to 200 μ s	200 ms to 100 μ s	200 ms to 50 μ s	200 ms to 20 μ s	200 ms to 10 μ s	200 ms to 10 μ s	200 ms to 10 μ s
81 hour (3 day 9 hour) to 100 hour (4 day 4 hour)	200 ms to 200 μ s	200 ms to 100 μ s	200 ms to 50 μ s	200 ms to 20 μ s	200 ms to 10 μ s	200 ms to 10 μ s	200 ms to 10 μ s
101 hour (4 day 5 hour) to 120 hour (5 day)	200 ms to 500 μ s	200 ms to 100 μ s	200 ms to 100 μ s	200 ms to 50 μ s	200 ms to 10 μ s	200 ms to 10 μ s	200 ms to 10 μ s
121 hour (5 day 1 hour) to 10 day	200 ms to 500 μ s	200 ms to 200 μ s	200 ms to 200 μ s	200 ms to 50 μ s	200 ms to 20 μ s	200 ms to 20 μ s	200 ms to 20 μ s
10 day 1 hour to 20 day	200 ms to 1 ms	200 ms to 500 μ s	200 ms to 200 μ s	200 ms to 100 μ s	200 ms to 50 μ s	200 ms to 50 μ s	200 ms to 50 μ s
20 day 1 hour to 30 day	200 ms to 2 ms	200 ms to 1 ms	200 ms to 500 μ s	200 ms to 200 μ s	200 ms to 100 μ s	200 ms to 100 μ s	200 ms to 100 μ s
30 day 1 hour to 40 day	200 ms to 2 ms	200 ms to 1 ms	200 ms to 500 μ s	200 ms to 200 μ s	200 ms to 100 μ s	200 ms to 100 μ s	200 ms to 100 μ s
40 day 1 hour to 50 day	200 ms to 5 ms	200 ms to 1 ms	200 ms to 500 μ s	200 ms to 500 μ s	200 ms to 100 μ s	200 ms to 100 μ s	200 ms to 100 μ s

* The values inside the parentheses are the maximum number of channels in a group. For how to count the number channels, see appendix 1.

Memory Expansion 8 Gpoint model (/M2 option)

Acquisition Time Set from the Menu	Number of Channels*						
	Up to 64 (32)	Up to 32 (16)	Up to 16 (8)	Up to 8 (4)	Up to 4 (2)	Up to 2 (1)	Up to 1
1 s	1 ms to 20 μ s	1 ms to 10 μ s	1 ms to 5 μ s	1 ms to 5 μ s	1 ms to 2 μ s	1 ms to 1 μ s	1 ms to 500 ns
2 s	2 ms to 20 μ s	2 ms to 10 μ s	2 ms to 5 μ s	2 ms to 5 μ s	2 ms to 2 μ s	2 ms to 1 μ s	2 ms to 500 ns
3 s to 5 s	5 ms to 20 μ s	5 ms to 10 μ s	5 ms to 5 μ s	5 ms to 5 μ s	5 ms to 2 μ s	5 ms to 1 μ s	5 ms to 500 ns
6 s to 10 s	10 ms to 20 μ s	10 ms to 10 μ s	10 ms to 5 μ s	10 ms to 5 μ s	10 ms to 2 μ s	10 ms to 1 μ s	10 ms to 500 ns
11 s to 20 s	20 ms to 20 μ s	20 ms to 10 μ s	20 ms to 5 μ s	20 ms to 5 μ s	20 ms to 2 μ s	20 ms to 1 μ s	20 ms to 500 ns
21 s to 30 s	50 ms to 20 μ s	50 ms to 10 μ s	50 ms to 5 μ s	50 ms to 5 μ s	50 ms to 2 μ s	50 ms to 1 μ s	50 ms to 500 ns
31 s to 40 s	50 ms to 20 μ s	50 ms to 10 μ s	50 ms to 5 μ s	50 ms to 5 μ s	50 ms to 2 μ s	50 ms to 1 μ s	50 ms to 500 ns
41 s to 50 s	50 ms to 20 μ s	50 ms to 10 μ s	50 ms to 5 μ s	50 ms to 5 μ s	50 ms to 2 μ s	50 ms to 1 μ s	50 ms to 500 ns
51 s to 60 s	100 ms to 20 μ s	100 ms to 10 μ s	100 ms to 5 μ s	100 ms to 5 μ s	100 ms to 2 μ s	100 ms to 1 μ s	100 ms to 500 ns
61 s to 100 s (1 min 40 s)	100 ms to 20 μ s	100 ms to 10 μ s	100 ms to 5 μ s	100 ms to 5 μ s	100 ms to 2 μ s	100 ms to 1 μ s	100 ms to 500 ns
101 s (1 min 41 s) to 200 s (3 min 20 s)	200 ms to 20 μ s	200 ms to 10 μ s	200 ms to 5 μ s	200 ms to 5 μ s	200 ms to 2 μ s	200 ms to 1 μ s	200 ms to 500 ns
201 s (3 min 21 s) to 300 s (5 min)	200 ms to 20 μ s	200 ms to 10 μ s	200 ms to 5 μ s	200 ms to 5 μ s	200 ms to 2 μ s	200 ms to 1 μ s	200 ms to 500 ns
301 s (5 min 1 s) to 600 s (10 min)	200 ms to 20 μ s	200 ms to 10 μ s	200 ms to 5 μ s	200 ms to 5 μ s	200 ms to 2 μ s	200 ms to 1 μ s	200 ms to 500 ns
10 min 1 s to 20 min	200 ms to 20 μ s	200 ms to 10 μ s	200 ms to 5 μ s	200 ms to 5 μ s	200 ms to 2 μ s	200 ms to 1 μ s	200 ms to 500 ns

Appendix 8 Acquisition/Record Time and Sample Interval (Recorder mode only)

Acquisition Time Set from the Menu	Number of Channels*						
	Up to 64 (32)	Up to 32 (16)	Up to 16 (8)	Up to 8 (4)	Up to 4 (2)	Up to 2 (1)	Up to 1
20 min 1 s to 30 min	200 ms to 20 μ s	200 ms to 10 μ s	200 ms to 5 μ s	200 ms to 5 μ s	200 ms to 2 μ s	200 ms to 1 μ s	200 ms to 500 ns
30 min 1 s to 40 min	100 ms to 20 μ s	100 ms to 10 μ s	100 ms to 5 μ s	100 ms to 5 μ s	100 ms to 2 μ s	100 ms to 1 μ s	200 ms to 500 ns
40 min 1 s to 50 min	200 ms to 20 μ s	200 ms to 10 μ s	200 ms to 5 μ s	200 ms to 5 μ s	200 ms to 2 μ s	200 ms to 1 μ s	200 ms to 500 ns
50 min 1 s to 60 min	200 ms to 20 μ s	200 ms to 10 μ s	200 ms to 5 μ s	200 ms to 5 μ s	200 ms to 2 μ s	200 ms to 1 μ s	200 ms to 500 ns
61 min to 100 min	200 ms to 20 μ s	200 ms to 10 μ s	200 ms to 5 μ s	200 ms to 5 μ s	200 ms to 2 μ s	200 ms to 1 μ s	200 ms to 500 ns
101 min (1 hour 41 min) to 120 min (2 hour)	200 ms to 20 μ s	200 ms to 10 μ s	200 ms to 5 μ s	200 ms to 5 μ s	200 ms to 2 μ s	200 ms to 1 μ s	200 ms to 500 ns
121 min (2 hour 1 min) to 300 min (5 hour)	200 ms to 20 μ s	200 ms to 10 μ s	200 ms to 5 μ s	200 ms to 5 μ s	200 ms to 2 μ s	200 ms to 1 μ s	200 ms to 500 ns
301 min (5 hour 1 min) to 10 hour	200 ms to 20 μ s	200 ms to 10 μ s	200 ms to 5 μ s	200 ms to 5 μ s	200 ms to 2 μ s	200 ms to 1 μ s	200 ms to 1 μ s
10 hour 1 min to 20 hour	100 ms to 20 μ s	100 ms to 10 μ s	100 ms to 5 μ s	100 ms to 5 μ s	100 ms to 2 μ s	100 ms to 2 μ s	100 ms to 2 μ s
20 hour 1 min to 30 hour (1 day 6 hour)	200 ms to 50 μ s	200 ms to 20 μ s	200 ms to 10 μ s	200 ms to 5 μ s	200 ms to 5 μ s	200 ms to 5 μ s	200 ms to 5 μ s
31 hour (1 day 7 hour) to 40 hour (1 day 16 hour)	200 ms to 50 μ s	200 ms to 20 μ s	200 ms to 10 μ s	200 ms to 5 μ s	200 ms to 5 μ s	200 ms to 5 μ s	200 ms to 5 μ s
41 hour (1 day 17 hour) to 50 hour (2 day 2 hour)	200 ms to 50 μ s	200 ms to 20 μ s	200 ms to 10 μ s	200 ms to 5 μ s	200 ms to 5 μ s	200 ms to 5 μ s	200 ms to 5 μ s
51 hour (2 day 3 hour) to 60 hour (2 day 12 hour)	200 ms to 50 μ s	200 ms to 50 μ s	200 ms to 20 μ s	200 ms to 5 μ s	200 ms to 5 μ s	200 ms to 5 μ s	200 ms to 5 μ s
61 hour (2 day 13 hour) to 80 hour (3 day 8 hour)	200 ms to 100 μ s	200 ms to 50 μ s	200 ms to 20 μ s	200 ms to 10 μ s	200 ms to 10 μ s	200 ms to 10 μ s	200 ms to 10 μ s
81 hour (3 day 9 hour) to 100 hour (4 day 4 hour)	200 ms to 100 μ s	200 ms to 50 μ s	200 ms to 20 μ s	200 ms to 10 μ s	200 ms to 10 μ s	200 ms to 10 μ s	200 ms to 10 μ s
101 hour (4 day 5 hour) to 120 hour (5 day)	200 ms to 100 μ s	200 ms to 100 μ s	200 ms to 50 μ s	200 ms to 10 μ s	200 ms to 10 μ s	200 ms to 10 μ s	200 ms to 10 μ s
121 hour (5 day 1 hour) to 10 day	200 ms to 200 μ s	200 ms to 200 μ s	200 ms to 50 μ s	200 ms to 20 μ s	200 ms to 20 μ s	200 ms to 20 μ s	200 ms to 20 μ s
10 day 1 hour to 20 day	200 ms to 500 μ s	200 ms to 200 μ s	200 ms to 100 μ s	200 ms to 50 μ s	200 ms to 50 μ s	200 ms to 50 μ s	200 ms to 50 μ s
20 day 1 hour to 30 day	200 ms to 1 ms	200 ms to 500 μ s	200 ms to 200 μ s	200 ms to 100 μ s	200 ms to 100 μ s	200 ms to 100 μ s	200 ms to 100 μ s
30 day 1 hour to 40 day	200 ms to 1 ms	200 ms to 500 μ s	200 ms to 200 μ s	200 ms to 100 μ s	200 ms to 100 μ s	200 ms to 100 μ s	200 ms to 100 μ s
40 day 1 hour to 50 day	200 ms to 1 ms	200 ms to 500 μ s	200 ms to 500 μ s	200 ms to 100 μ s	200 ms to 100 μ s	200 ms to 100 μ s	200 ms to 100 μ s

* The values inside the parentheses are the maximum number of channels in a group. For how to count the number channels, see appendix 1.

Appendix 9 Default Settings

Panel Key	Soft Key	Setting
CH1 to 16 (4CH10M16 (720256))		
	Input	ON
	V/div	50.00 V/div
	Position	0.00 div
	Label	
	Sub channel number 1	CH<x>_1
	Sub channel number 2	CH<x>_2
	Coupling	DC
	Probe	10:1
	BandWidth	Full
	V Scale	DIV
	V Zoom	×1
	Offset	0.00 V
	Invert	OFF
	Linear Scale	OFF

CH1 to 16 (HS10M12 (701250/720250))		
	Input	ON
	V/div	50.0 V/div
	Position	0.00 div
	Label	Channel number
	Coupling	DC
	Probe	10:1
	BandWidth	Full
	V Scale	DIV
	V Zoom	×1
	Offset	0.0 V
	Invert	OFF
	Linear Scale	OFF

CH1 to 16 (HS1M16 (701251))		
	Input	ON
	V/div	50.0 V/div
	Position	0.00 div
	Label	Channel number
	Coupling	DC
	Probe	10:1
	BandWidth	Full
	V Scale	DIV
	V Zoom	×1
	Offset	0.00 V
	Invert	OFF
	Linear Scale	OFF

CH1 to 16 (NONISO_10M12 (701255))		
	Input	ON
	V/div	50.0 V/div
	Position	0.00 div
	Label	Channel number
	Coupling	DC
	Probe	10:1
	BandWidth	Full
	V Scale	DIV
	V Zoom	×1
	Offset	0.0 V
	Invert	OFF
	Linear Scale	OFF

CH1 to 16 (HV (with RMS))(720268))		
	Input	ON
	V/div	5.000 V/div

Panel Key	Soft Key	Setting
	Position	0.00 div
	Label	Channel number
	Coupling	DC
	BandWidth	Full
	V Scale	DIV
	V Zoom	×1
	Offset	0.000 V
	Invert	OFF
	Linear Scale	OFF

CH1 to 16 (UNIVERSAL (701261)/UNIVERSAL (AAF) (701262))		
	Input	ON
	V/div	5.000 V/div
	Position	0.00 div
	Label	Channel number
	Coupling	DC
	BandWidth	Full
	V Scale	DIV
	V Zoom	×1
	Offset	0.000 V
	Invert	OFF
	Linear Scale	OFF

CH1 to 16 (TEMP/HPV (701265/720266))		
	Input	ON
	V/div	5.000 V/div
	Position	0.00 div
	Label	Channel number
	Coupling	DC
	BandWidth	Full
	V Scale	DIV
	V Zoom	×1
	Offset	0.000 V
	Invert	OFF
	Linear Scale	OFF

CH1 to 16 (STRAIN_NDIS (701270)/STRAIN_DSUB (701271))		
	Input	ON
	Value/div	4000.0 μSTR/div
	Range	±20000 μSTR
	Label	Channel number
	Excitation	2 V
	Gauge Factor	2.00
	BandWidth	Full
	Upper	20000 μSTR
	Lower	-20000 μSTR
	Range Unit	μSTR
	Invert	OFF
	Linear Scale	OFF

CH1 to 16 (ACCL/VOLT (701275))		
	Input	ON
	V/div	50.0 V/div
	Position	0.00 div
	Label	Channel number
	Coupling	DC
	Probe	10:1
	BandWidth	Full
	V Scale	DIV

Panel Key	Soft Key	Setting
	V Zoom	×1
	Offset	0.00 V
	Invert	OFF
	Linear Scale	OFF
CH1 to 16 (FREQ (701281/720281))		
	Input	ON
	Value/div	1 kHz/div
	Position	0.00 div
	Label	Channel number
	FV Setup	Frequency
	Input Setup	User
	V Scale	DIV
	V Zoom	×1
	Offset	0.000 Hz
	Linear Scale	OFF
CH1 to 16 (HS200M14 (720212))		
	Input	ON
	V/div	50.0 V/div
	Position	0.00 div
	Label	Channel number
	Coupling	DC
	Probe	10:1
	BandWidth	Full
	V Scale	DIV
	V Zoom	×1
	Offset	0.0 V
	Invert	OFF
	Linear Scale	OFF
CH1 to 16 (HS100M12 (720211))		
	Input	ON
	V/div	50.0 V/div
	Position	0.00 div
	Label	Channel number
	Coupling	DC
	Probe	10:1
	BandWidth	Full
	V Scale	DIV
	V Zoom	×1
	Offset	0.0 V
	Invert	OFF
	Linear Scale	OFF
CH1 to 16 (16CH1 to 16TEMP/VOLT (720221))		
	Input	ON
	V/div	200.0 mV/div
	Position	0.00 div
	Data Update Period	100 ms
	Label	Channel number
	Coupling	DC
	V Scale	DIV
	V Zoom	×1
	Offset	0.0 mV
	Invert	OFF
	Linear Scale	OFF
CH1 to 16 (LOGIC (720230))		
	Input	ON
	Position	0.00 div
	Label	Channel number
	Bit Mapping	Auto
CH13 to 16 (CAN MONITOR (720240))		
	Input	ON
	All SubChannels Setup	
	Input	OFF

Panel Key	Soft Key	Setting
	Label	Channel number
	Message Format	STD
	ID (Hex)	000
	Byte Count	Auto
	Start Bit	0
	Bit Count	8
	Byte Order	Big
	Value Type	Unsigned
	Factor	1.0000
	Offset	0.0000
	Port Setup	
	Bit Rate	500 Kbps
	Sample Point	85 %
	Sync Jump Width	2
	Bit Sample Num	1
	Listen Only	OFF
	Terminator	OFF
	Scale	Auto
	One Shot Out	
	Message Format	STD
	ID (Hex)	000
	Frame	Data
	DLC	0
	Data (Hex)	00 00 00 00

CH13 to 16 (CAN & LIN (720241))

The values for CAN are the same as the values for the 720240.

	Input	ON
	All SubChannels Setup	
	Input	OFF
	Label	Sub Channel Number
	ID (Hex)	0
	Start Bit	0
	Bit Count	8
	Byte Order	Little
	Value Type	Unsigned
	Factor	1
	Offset	0
	Port Setup	
	Bit Rate	19200 bps
	Frame Setup	
	Data Length	1
	Check Sum	Classic
	Scale	Auto

CH13 to 16 (CAN/CAN FD (720242))

	Input	ON
	All SubChannels Setup	
	Input	OFF
	Label	Channel number
	Message Format	STD
	ID (Hex)	000
	Byte Count	Auto
	Start Bit	0
	Bit Count	8
	Byte Order	Big
	Value Type	Unsigned
	Factor	1.0000
	Offset	0.0000
	Port Setup	

Appendix 9 Default Settings

Panel Key	Soft Key	Setting
	FD Standard (CAN FD)	ISO
	Bit Rate	500 Kbps
	Sample Point	85 %
	Data Bit Rate (CAN FD)	1 Mbps
	Sample Point (CAN FD)	85 %
	Listen Only	OFF
	Terminator	OFF
	One Shot Out	
	Message Type	CAN FD
	Message Format	STD
	ID (Hex)	000
	Frame	Data
	DLC	0
	Data (Hex)	0x00
CH9 to 16 (SENT (720243))		
	Input	ON
	SENT Format Setup	
	Clock Tick	3.00 µs
	Data Nibbles Number	6
	Pause Pulse	ON
	CRC Type	Recommended
	Slow CH Type	Enhanced (ID8bit + Data12bit)
	Fast Channel Multiplexing	OFF
	Error Channel Setup	
	Fast Channel CRC	
	Detect	—
	Error Trigger	ON
	Error Count	ON
	Slow Channel CRC	
	Detect	—
	Error Trigger	ON
	Error Count	ON
	Nibble Value	
	Detect	—
	Error Trigger	ON
	Error Count	ON
	Successive Calibration Pulses (Option2)	
	Detect	OFF
	Error Trigger	ON
	Error Count	ON
	Pulse Number	
	Detect	—
	Error Trigger	ON
	Error Count	ON
	Error Count Reset on Start	ON
	Input Setup	
	Probe	1:1
	Time Out	2000.0 ms
	All SubChannels Setup	

Panel Key	Soft Key	Setting
	Sub Channel Number	Data Type Input Label
	1	FastCH ON CH<x>_F1
	2	FastCH ON CH<x>_F2
	3	FastCH ON CH<x>_F3
	4	S&C ON CH<x>_SC
	5	SlowCH ON CH<x>_S1
	6	SlowCH ON CH<x>_S2
	7	SlowCH ON CH<x>_S3
	8	SlowCH ON CH<x>_S4
	9	SlowCH ON CH<x>_S5
	10	Error Trigger ON CH<x>_ET
	11	Error Count ON CH<x>_EC
	(When Data Type is FastCH)	
	FC	0x00
	Endian	Big
	Start Bit	
	Fast CH1	0
	Fast CH2	12
	Fast CH3	0
	Bit Size	12
	Value Type	Unsigned
	Factor	1.00
	Offset	0.00
	Unit	""
	(When Data Type is S&C)	
	Bit0	
	Display	ON
	Label	Bit0
	Bit1	
	Display	ON
	Label	Bit1
	Bit2	
	Display	ON
	Label	Bit2
	Bit3	
	Display	ON
	Label	Bit3
	V Zoom	×1.0
	(When Data Type is SlowCH)	
	ID	0x00
	Start Bit	0
	Bit Size	12
	Value Type	Unsigned
	Factor	1.00
	Offset	0.00
	Unit	""
	(When Data Type is Error Trigger)	
	V Zoom	×1.0
CH1 to 16 (4CH 1M16 (720254))		
	Input	ON
	V/div	50.00 V/div
	Position	0.00 div
	Label	
	Sub channel number 1	CH<x>_1
	Sub channel number 2	CH<x>_2
	Coupling	DC

Panel Key	Soft Key	Setting
	Probe	10:1
	BandWidth	Full
	V Scale	DIV
	V Zoom	×1
	Offset	0.00 V
	Invert	OFF
	Linear Scale	OFF
RT.MATH CH1 to 16		
	Input	OFF
	Label	RTmath<x>
START/STOP		
		STOP
SETUP	System Mode	Scope Mode
	Remote Setup	
	Remote Mode	OFF
TIME/DIV		
		10 ms/div
ACQUIRE		
	RecordLength	10 k
	Acquisition Mode	Normal
	Trigger Mode	Auto
	Acquisition Count	OFF
	SSD Recording	OFF
	Time Base	Internal
DUAL CAPTURE		
		OFF
FILE		
	Save Waveform	
	File Name	
	Auto Naming	Numbering
	File Name	None
	Comment	None
	Data Type	
	Binary	ON
	ASCII	OFF
	MATLAB	OFF
	Range	Main
	Waveform Save (Binary)	
	History	One
	P-P Comp	OFF
	Waveform Save (ASCII)	
	Time Info.	OFF
	Decimal Point	Point
	Sub Channel	Supplement
	Waveform Save (MATLAB)	
	Information Text	OFF
	Select Save Trace	
	Trace	ON
	Save Setup	
	File Name	
	Auto Naming	Numbering
	File Name	None
	Comment	None
	Save Others	
	File Name	
	Auto Naming	Numbering
	File Name	None
	Comment	None
	Data Type	Screen Image
	Image Format	PNG
	Image Color	ON

Panel Key	Soft Key	Setting
	Image Background	Normal
SAVE MENU		
	Binary	ON
	ASCII	OFF
	MATLAB	OFF
IMAGE SAVE MENU		
	Target	File
DISPLAY		
	Select Group	Gr.1
	Format	4
	Graticule	Grid
	File Grid	OFF
	Brightness	5
	Scale Display	All
	Scale Font Size	Small
	Horizontal Scale Display	Auto
	Format	
	Extra Window	OFF
	Analysis Max Line	8
	Analysis Font Size	Small
	Color Theme	Default
	Trace Label	OFF
	Level Indicator	ON
	Channel Information	OFF
	Channel Information	Narrow
	Width	
	Manual Event	OFF
	Dot Connect	Line
	Display Group Setup	
	Mapping Mode	Auto
	Accumulate	OFF
X-Y		
	Window Select	Window1
	Dislay	OFF
	Start Point	-5.00 div
	End Point	5.00 div
	Pen Marker	OFF
	Cursro	
	Mode	OFF
	Main Ratio	50 %
	Window Layout	Side
	Combine Display	OFF
	Dot Connect	Line
	Decimation	2k
	Trace Clear on Start	ON
TRIGGER		
	Setting	Simple
	Source	CH1
	Slope	Rise
	Level	0.0 V
	Hysteresis	Low
	Position/Delay	
	Position	50.0 %
	Hold Off	0 s
	Delay Time	0 s
CURSOR		
	Mode	OFF
MEASURE		
	Mode	OFF
GO/NO-GO		

Appendix 9 Default Settings

Panel Key	Soft Key	Setting	Panel Key	Soft Key	Setting
FFT	Mode	OFF		Network Timeout	Infinite
	Window1	OFF		Network Interface	10G
	Window2	OFF		TCP/IP 10G	
MATH				DHCP	OFF
	Mode	OFF		IP Address	192.168.0.101
HISTORY				Net Mask	255.255.255.0
	Display Mode	1 Record		DNS	OFF
	Select Record	0		TCP/IP	
	Start	0		DHCP	ON
	End	0		DNS	Auto
ANALYSIS	Search Mode	OFF		FTP/Web Server	
	Power			User Name	anonymous
	Analysis Mode	OFF		TimeOut	1800 s
	Harmonic			Interface	1G
ZOOM	Analysis Mode	OFF		Mail	
	Zoom1 Display	OFF		Mail Server	None
	Zoom2 Display	OFF		Mail Address	None
SEARCH				Comment	None
	Type	Edge		Attached Image File	OFF
	Edge Setup			TimeOut	15 s
	Trace	CH1		Interface	1G
	Level	0 V		Network Print	
	Polarity	Rise		LPR Server	None
	Hysteresis	Low		LPR Name	PASSTHRU
	Count	1		TimeOut	15 s
	Start Point	-5.00 div		Net Drive	
	End Point	5.00 div		FTP Server	None
UTILITY				Login Name	anonymous
	System Config			Password	None
	Date/Time			Passive	ON
	Display	ON		Timeout	15 s
	Format	2020/9/2		Interface	1G
	Time Zone	9H 00M		SNTP	
	Time Sync			SNTP Server	None
	Time Sync	OFF		TimeOut	3 s
	IEEE1588 Setup			Ajust at PowerON	OFF
	Delay Mechanism	E2E		Interface	1G
	Network Layer	Layer3		Power On Action	
	Domain Number	0		Start	OFF
	Master Mode	Master/Slave		Action	ON
	Master Source	Internal		Start Mode	Stanby Startup
	Priority1	128		Logic Setup	
	Priority2	128		Numerical Format	Bit
	Leap Second	37		Cursor	1 -> 8
	IRIG Setup			Bit Order	1 -> 8
	Format	A		Terminal Setup	
	Modulation	AM		Remote Stop	ON
	Impedance	50		Trigger Out	Normal
	Language			External Sample Out	OFF
	Menu	Default language		Key/Knob Setup	
	Message	Default language		Click Sound	ON
	USB Keyboard	Japanese		START/STOP	Quick
	LCD/TouchPanel			Response Time	
	Auto OFF	OFF		KeyProtect Type	All
Auto OFF Time	1 min		KeyProtect Release	Key	
Brightness	8		Type		
Touch Panel	ON		Other Setup		
Remote Control			Beep on Error	ON	
USB Function	TMC		SelfTest	Keyboard	

Appendix 10 USB Keyboard Key Assignments

DL950	USB Keyboard
AQUIRE	CTRL+A
FFT	CTRL+B
DISPLAY	CTRL+D
Execute IMAGE SAVE	CTRL+E
FILE	CTRL+F
HELP	CTRL+G
HISTORY	CTRL+H
Executing an SAVE	CTRL+I
MANUAL (manual trigger)	CTRL+J
KEY PROTECT	CTRL+K
ALL CH	CTRL+L
MEASURE	CTRL+M
APPLICATION	CTRL+P
Execute CLEAR TRACE	CTRL+Q
Executing an RESET	CTRL+R
SHIFT	CTRL+S
TRIGGER MENU	CTRL+T
CURSOR	CTRL+U
ZOOM	CTRL+Z
CH	CTRL+1
SET	CTRL+ENTER
SETUP	CTRL+\
UTILITY	CTRL+/
RT. MATH CH	CTRL+F1
Turn ZOOM POSITION clockwise	CTRL+INSERT
Turn VERTICAL POSITION clockwise	CTRL+HOME
Turn ZOOM POSITION counterclockwise	CTRL+DELETE
Turn VERTICAL POSITION counterclockwise	CTRL+END
START/STOP	CTRL+* or F12
DUAL CAPTURE	CTRL+SHIFT+A
MATH	CTRL+SHIFT+B
X-Y	CTRL+SHIFT+D
IMAGE SAVE MENU	CTRL+SHIFT+E
ANALYSIS	CTRL+SHIFT+H
SAVE MENU	CTRL+SHIFT+I
GO/NO-GO	CTRL+SHIFT+M
ACTION	CTRL+SHIFT+T
SEARCH	CTRL+SHIFT+Z
CAL	CTRL+SHIFT+\
ESC	ESC or F8
Select soft key 1	F1
Select soft key 2	F2
Select soft key 3	F3
Select soft key 4	F4
Select soft key 5	F5
Select soft key 6	F6
Select soft key 7	F7
SNAPSHOT	Pause
Turn ZOOM MAG clockwise	Insert
Turn VERTICAL SCALE clockwise	Home
Turn HORIZONTAL TIME/DIV clockwise	PageUp
Turn ZOOM MAG counterclockwise	Delete
Turn VERTICAL SCALE counterclockwise	End
Turn HORIZONTAL TIME/DIV counterclockwise	PageDown
Right arrow	→
Left arrow	←
Up arrow	↑
Down arrow	↓

Appendix 11 Block Diagram

Block Diagram of the Instrument

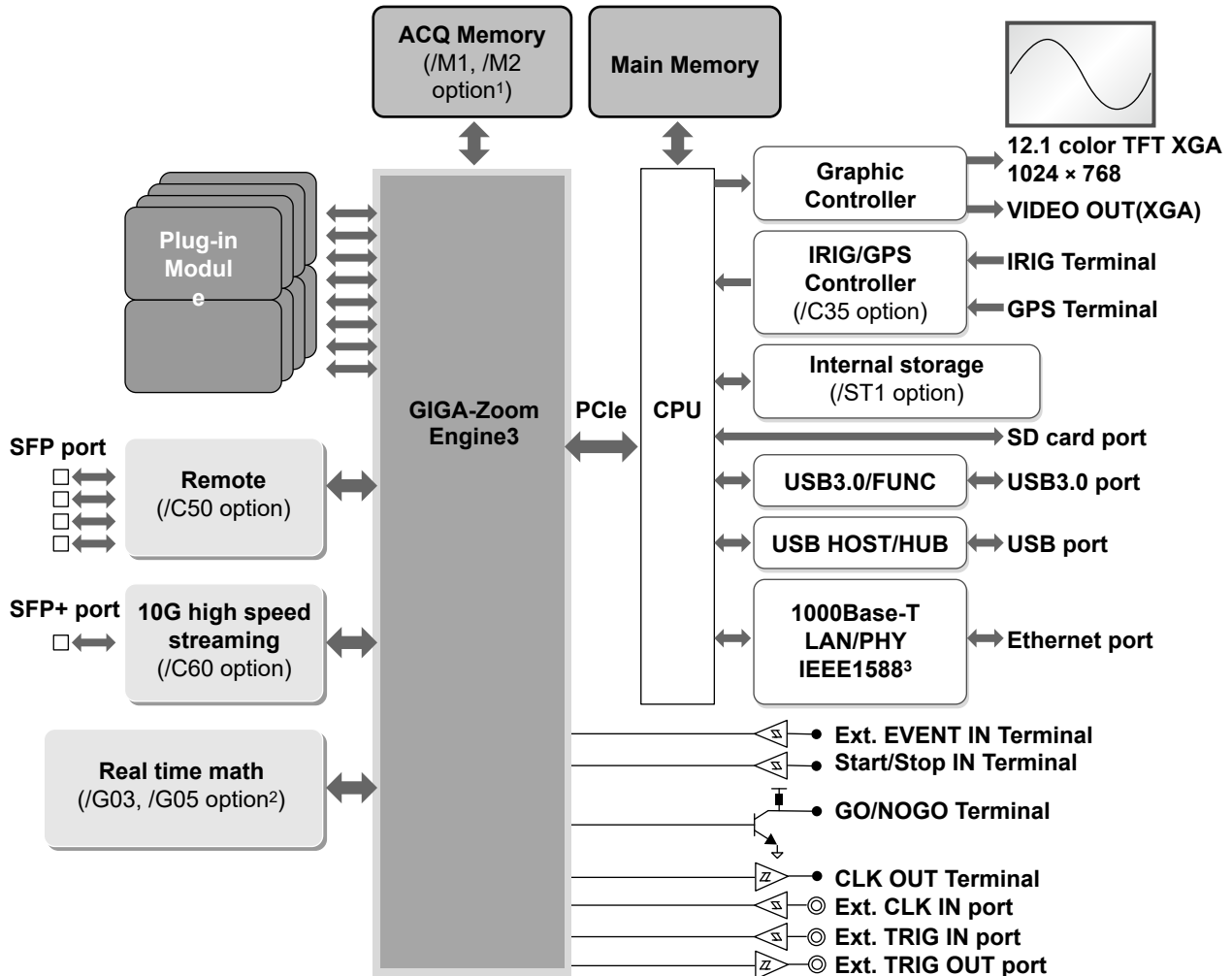

- 1 The /M1 and /M2 options cannot be installed on the same instrument.
- 2 The /G03 and /G05 options cannot be installed on the same instrument.
- 3 The master feature is a /C40 option.

Signal Flow of the Instrument

The input terminal signal flow varies for each model. In this example, we will explain the signal flow for the High-Speed 10 MS/s, 12-Bit Isolation Module, 701250 (HS10M12). (For the signal flow of a particular module, see the module's block diagram.)

The input signal applied to the two input terminals is first processed by each module's input section. In the 701250 (HS10M12), the input signal is attenuated and amplified by an attenuator (ATT) and amplifier (AMP). Then, the signal's bandwidth is limited by a filter (FLT). Next, the signal is sampled at a rate of 10 MS/s (10,000,000 times a second) by an A/D converter and converted into digital data. Then, the signal passes through the FPGA and enters GIGAZoom Engine3.

16 channels of digital data is stored in the acquisition memory via the waveform processing GIGAZoom Engine3 (ACQ Memory). The digital data in the ACQ Memory is compressed by GIGAZoom Engine3 at high speeds and displayed on the XGA TFT color display via the graphic controller.

The real time math function (/G03 /G05 option) uses the A/D converted data of the analog input channels or the math results of real time math channels or both as its math sources and performs math operations on the specified channels in real time. You can use the instrument to perform real time math on up to 16 channels at the same time.

Plug-in Module Block Diagram

720256 (4CH10M16)

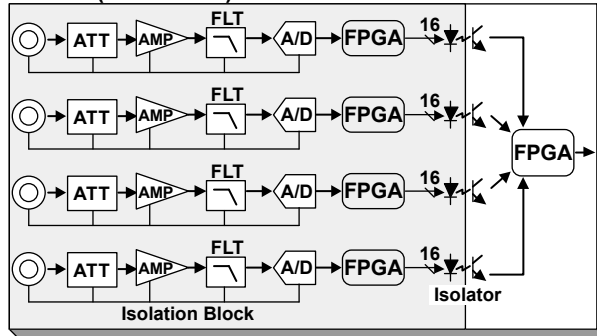

701250 (HS10M12)

720250 (HS10M12)

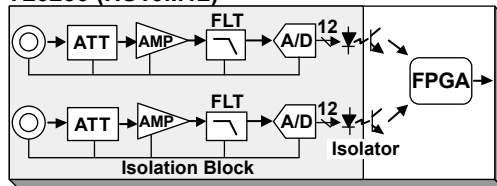

701251 (HS1M16)

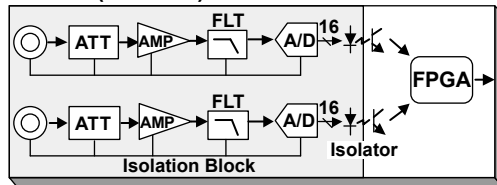

701255 (NONISO_10M12)

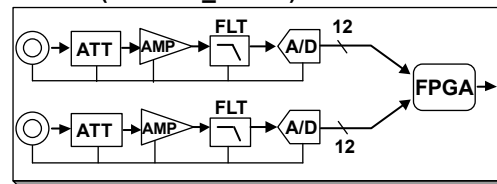

720268 (HV (AAF, RMS))

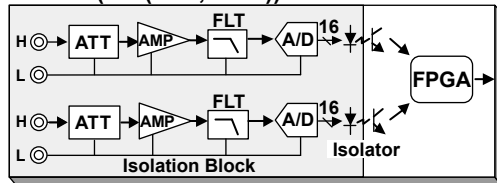

701261 (UNIVERSAL)

701262 (UNIVERSAL (AAF))

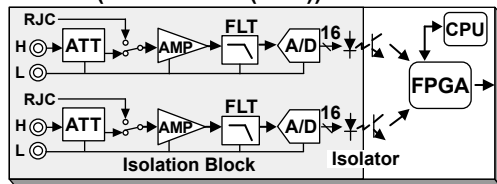

Appendix 11 Block Diagram

701265 (TEMP/HPV)
720266 (TEMP/HPV)

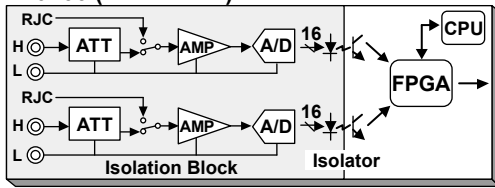

701270 (STRAIN_NDIS)
701271 (STRAIN_DSUB)

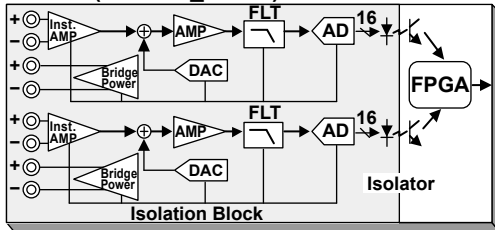

701275 (ACCL/VOLT)

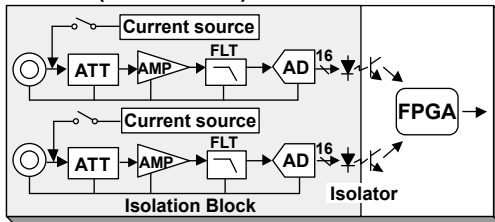

701281 (FREQ)
720281 (FREQ)
720243 (SENT)

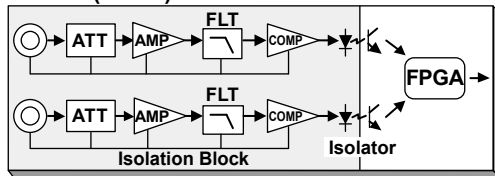

720212 (HS200M14)

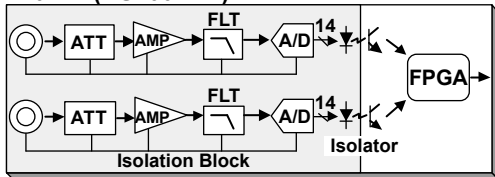

720211 (HS100M12)

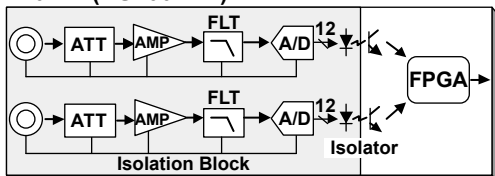

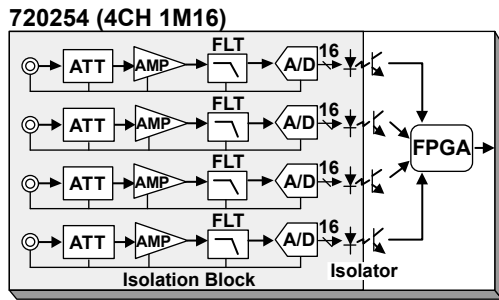
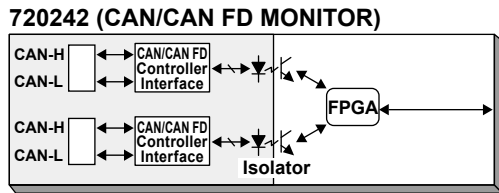
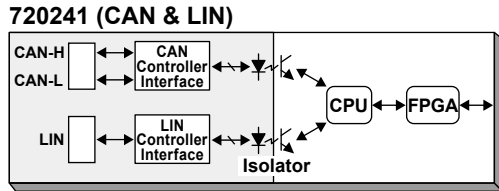
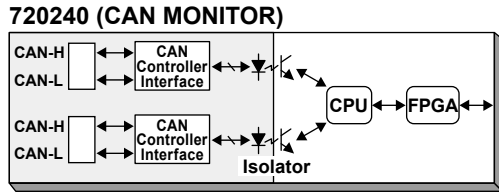
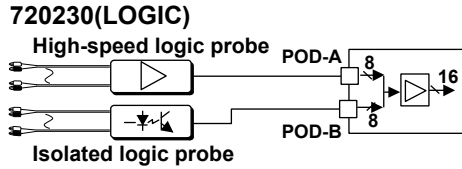
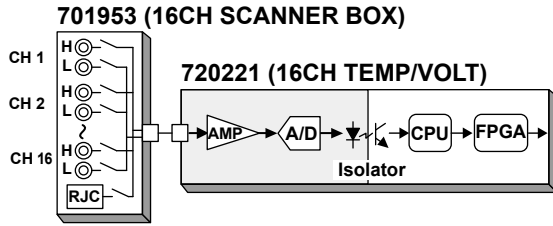

Appendix 12 Modules' Maximum Input Voltages

When checking the maximum input voltage of a module, you need to consider not only the voltage across input terminals but also the isolation voltage of each terminal. In addition, the voltage that can be measured varies depending on the connection cable used in combination with the module.

When Combining with a Safety Lead

When you use a safety lead, you can measure up to the maximum input voltage given in the module specifications. However, the isolation voltage of each input terminal needs to be less than the maximum rated voltage to ground.

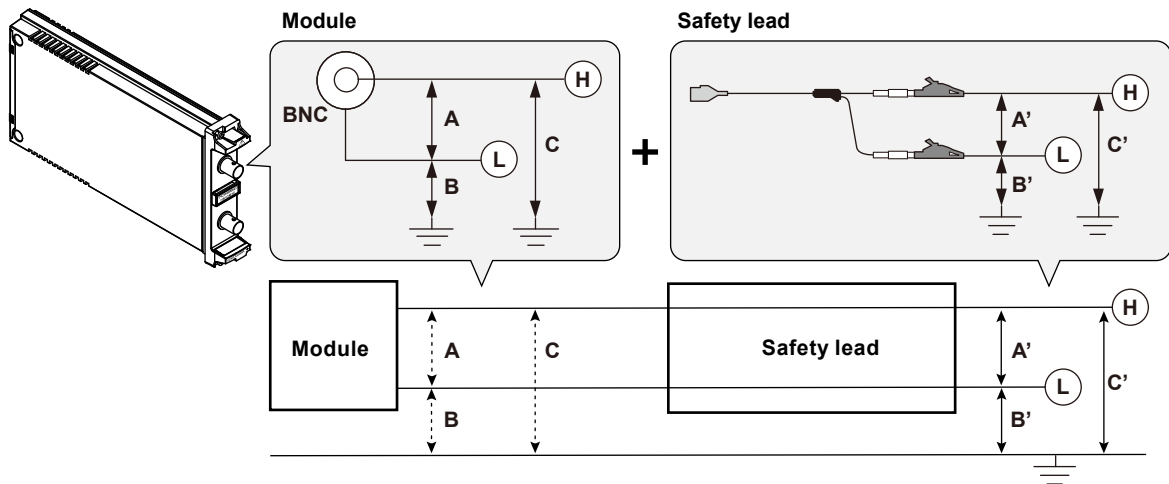

Module Specifications

- Input voltage across terminals ($A=A'$) \leq Maximum input voltage
- L terminal's isolation voltage ($B=B'$) \leq Maximum rated voltage to ground
- H terminal's isolation voltage ($C=A+B$) \leq Maximum rated voltage to ground

Example of Calculating Whether the Module Can Be Used

The following is an example of determining whether a module can be used based on the actual input voltage.

- When an isolation module (720250) is used in combination with the 701901 + 701954 (1:1)
- If any of the determination results is NG, the module cannot be used.

Actual Input Voltage		Example 1		Example 2 ²		Example 3 ³		
Voltage at the safety lead tip	A'	180 V		220 V		200 V		
	B'	200 V		180 V		250 V		
Determination Result	Upper Limit ¹	Voltage	Judgment	Voltage	Judgment	Voltage	Judgment	
Module terminal voltage	A = A'	Maximum input voltage: 200 V (DC+ACpeak)	180 V	OK	220 V	NG	200 V	OK
	B = B'	Maximum rated voltage to ground: 400 Vrms	200 V	OK	180 V	OK	250 V	OK
	C = A+B	Maximum rated voltage to ground: 400 Vrms	380 V	OK	400 V	OK	450 V	NG
Whether the Module Can Be Used		Yes		No		No		

1 For the upper value limit, see section 6.13, "Module Specifications."
If an rms value is indicated, multiplied by $\sqrt{2}$ (1.4) to convert to a peak value. If the value varies depending on the measurement category, calculate it by applying the category value to be used.

2 Cannot be used because the maximum input voltage is exceeded.

3 Cannot be used because the H terminal's isolation voltage is greater than the maximum rated voltage to ground.

When Combining with a Safety Probe

When you use a safety probe, you can measure up to the voltage that corresponds to the probe attenuation (when the attenuation is 10:1, up to 10 times the maximum input voltage given in the module specifications).

However, the isolation voltage of each input terminal needs to be less than the maximum rated voltage to ground.

In addition, the probe tip input voltage must be less than or equal to the maximum input voltage given in the probe specifications and the maximum rated voltage to ground.

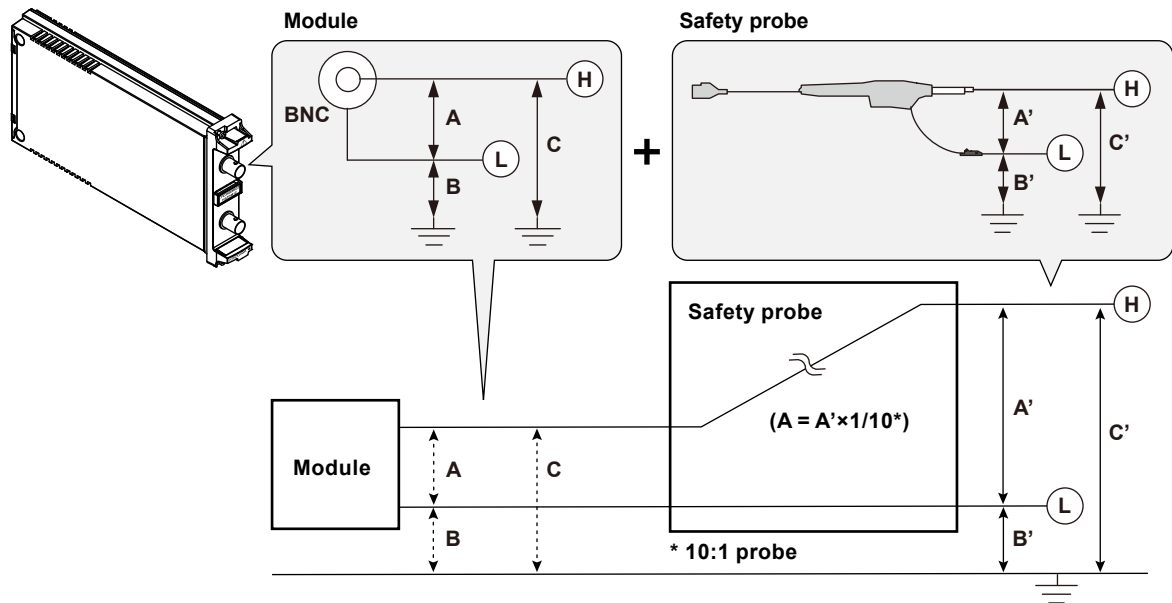

Module Specifications

- Input voltage across terminals ($A = A' \times 1/10$ (for a 10:1 probe)) \leq Maximum input voltage
- L terminal's isolation voltage ($B = B'$) \leq Maximum rated voltage to ground
- H terminal's isolation voltage ($C = A + B$) \leq Maximum rated voltage to ground

Probe Specifications

- Between the pincher tip and safety ground lead (A') \leq Maximum input voltage
- Between the safety ground lead and ground (B') \leq Maximum rated voltage to ground
- Between the pincher tip and ground ($C' = A' + B'$) \leq Maximum rated voltage to ground

Appendix 12 Modules' Maximum Input Voltages

Example of Calculating Whether the Module Can Be Used

The following is an example of determining whether a module can be used based on the actual input voltage.

- When an isolation module (720250) is used in combination with the 700929 (10:1 safety probe)
- If any of the determination results is NG, the module cannot be used.

Actual Input Voltage		Example 1		Example 2 ³		Example 3 ⁴		
Probe tip voltage	A'	700 V		400 V		1000 V		
	B'	300 V		390 V		300 V		
Determination Result	Upper Limit ¹	Voltage	Judgment	Voltage	Judgment	Voltage	Judgment	
Probe tip voltage	A'	Maximum input voltage: ² 1000 Vrms	700 V	OK	400 V	OK	1000 V	OK
	B'	Maximum rated voltage to ground: ² 1000 Vrms	300 V	OK	390 V	OK	300 V	OK
	C' = A' + B'	Maximum rated voltage to ground: ² 1000 Vrms	1000 V	OK	790 V	OK	1300 V	NG
Module terminal voltage	A = A' × 1/10	Maximum input voltage: 200 V (DC+ACpeak)	70 V	OK	40 V	OK	100 V	OK
	B = B'	Maximum rated voltage to ground: 400 Vrms	300 V	OK	390 V	OK	300 V	OK
	C = A+B	Maximum rated voltage to ground: 400 Vrms	370 V	OK	430 V	NG	400 V	OK
Whether the Module Can Be Used		Yes		No		No		

- 1 For the upper module terminal voltage limit, see section 6.13, "Module Specifications." However, calculate the maximum input voltage using the combined value of 701901 + 701954 (1:1). It will be 200 V in the case of an isolation module (720250).
If an rms value is indicated, multiplied by $\sqrt{2}$ (1.4) to convert to a peak value. If the value varies depending on the measurement category, calculate it by applying the category value to be used.
For the upper probe tip voltage, see the manual for the probe.
- 2 The higher the input signal frequency, the lower the maximum probe input voltage and maximum rated voltage to ground. For details, see the manual for the probe.
- 3 Cannot be used because the H terminal's isolation voltage is greater than the maximum rated voltage to ground.
- 4 Cannot be used because the voltage between the probe pincher tip and ground is greater than the maximum rated voltage to ground.

Note

When Using Direct Input

When a signal is directly applied to a module terminal (using a cable not complying with the safety standard), the maximum input voltage is 42 V (DC+ACpeak) and the maximum rated voltage to ground is 42 V (DC+ACpeak) (CAT II 30 Vrms), regardless of the module specifications.

L Terminal's Isolation Voltage and Maximum Input Voltage

Even when the module and the connection cable in use are the same, if the H terminal's isolation voltage has reached the maximum rated voltage to ground, the higher the L terminal's isolation voltage, the lower the voltage that can be applied (less than the maximum voltage given in the module specifications).

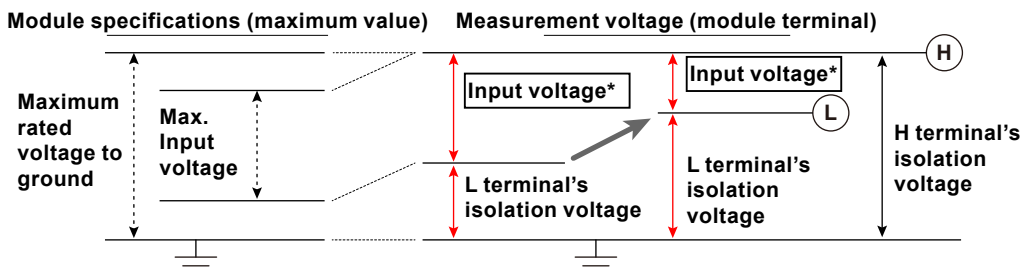

- * When using the safety probe, if the probe attenuation is 10:1, you can apply up to 10 times the input voltage to the probe tip. However, input exceeding the probe tip's maximum input voltage or maximum rated voltage to ground is not allowed.

Index

Numerics

16-CH scanner box..... 3-56, 7-65

A

accurate measurements 3-4, 3-18
ACQUIRE (DUAL CAPTURE) key 1-7
acquisition condition 2-5
acquisition mode 2-5, 4-17
acquisition time 2-4, App-4
A Delay B trigger 2-8
ALL CH key 1-6
AND Trigger 2-9
appendix, how to use App-1
APPLICATION key 1-9
application menu 2-1
arrow keys 1-9
A to B(N) trigger 2-8
auto calibration 4-16
automated measurement of waveform parameters 2-12
auto setup 4-14

B

block diagram App-64

C

calibration 4-16
CAN & LIN Bus Monitor Module 3-63
channel information 1-11, 1-16
channel setup 2-2
character input position 4-7
CH key 1-6
CLEAR TRACE key 1-10
clock trigger 2-8, 2-9
component names 3-57
 front panel 1-1
 left side panel 1-3
 right side panel 1-2
 screens 1-11
 top panel 1-1
connection
 16-CH Temperature/Voltage Input Module 3-56
 acceleration sensor 3-50
 bridgehead 3-43
 CAN Bus Monitor, CAN/CAN FD Monitor Module 3-61
 frequency module 3-53
 logic probe 3-46
 measurement lead 3-36
 probe 3-19
 thermocouple 3-40
connection cables 3-13
contents of the package, checking iv
CURSOR key 1-7
cursor measurement 2-12

D

default values App-58
digital filter 2-14
display record length 2-4, App-3
DISPLAY (X-Y) key 1-10
disposal 6-18
drag 4-4

dual capture 1-7, 2-6, App-49

E

Edge On A trigger 2-8
edge trigger 2-9
ESC Key 1-9, 4-2
event input 5-9
execution errors 6-7
external clock 2-5
external clock input 5-4
external signal trigger 2-8
external start/stop 5-9
external trigger input 5-1

F

faults and corrective actions 6-1
favorites 2-1
FFT 2-13
FFT (MATH) key 1-7
file errors 6-5
FILE key 1-10
frequency module 3-12, 3-35, 3-53

G

GIGAZoom 2-11
GO/NO-GO 2-13
GPS signal input 5-14
GPS unit 3-66

H

help 1-10, 4-18
history 2-7
HISTORY (ANALYSIS) key 1-7
hold down 4-4
horizontal axis 1-7, 2-4
horizontal installation 3-5
how number of channels is counted App-5

I

IMAGE SAVE (MENU) key 1-9
information 6-3
initialization 4-12
input coupling 2-2
input module
 installation 3-10
 specifications 7-20
 type vii, 1-4, 3-9
installation conditions 3-3
installation orientation 3-5
instrument number v
internal clock 2-5
IRIG signal input 5-13

J

jog dial 1-9, 4-1

K

keyboard 4-8
KEY PROTECT key 1-10
keys 1-6, 4-1

Index

L **Page**

linear scaling.....	2-3
logic probe.....	7-63

M **Page**

MAG knob.....	1-8
main power switch.....	3-16
MANUAL key.....	1-7
math.....	2-12
power math function.....	2-14
real time math function.....	2-14
maximum input voltage.....	xv, App-68
maximum rated voltage to ground.....	xv, App-68
MEASURE (GO/NO-GO) key.....	1-7
memory join group.....	App-5
MENU (ACTION) key.....	1-7
messages.....	6-3

N **Page**

network errors.....	6-7
numeric input.....	4-6
numeric keypad input.....	4-5
numeric monitor.....	1-11, 1-16

O **Page**

operation mode.....	2-1, 4-13
optical fiber cord.....	ix, 3-70
optical transceiver module.....	ix, 3-68
optional accessories (sold separately).....	viii
OR trigger.....	2-8, 2-9
over-range indication.....	3-24, 3-37, 3-40, 3-50, 3-53, 3-57
overview.....	6-17

P **Page**

panel sheet.....	3-65
period trigger.....	2-9
phase compensation signal.....	3-35
phase correction.....	3-33
pinch.....	4-4
pop-up menu.....	1-11, 1-16
power cord.....	v, 3-1, 3-15
power line signal trigger.....	2-8
power switch.....	3-16
pre-trigger.....	2-10
printer errors.....	6-7
pulse width trigger.....	2-9

R **Page**

recommended part replacement.....	6-18
Recorder mode.....	1-16, 2-1, 4-13, App-4
recording time.....	2-4, App-4
record length.....	2-4, App-2
RESET key.....	1-9, 4-2
RT.MATH CH key.....	1-6
rubber stoppers.....	v, 3-6

S **Page**

sample clock output.....	5-5
sample interval.....	2-3, 2-4, App-4
sample rate.....	2-3, 2-4, App-2, App-5
SAVE (MENU) key.....	1-9
SCALE knob.....	1-6
Scope mode.....	1-11, 2-1, 4-13, App-2

self-test.....	6-15
self-test, if an error occurs during.....	6-16
SENT Monitor Module.....	3-12, 3-35
SET Key.....	1-9, 4-2
setting errors.....	6-10
settings, initialization.....	4-12
SETUP (CAL) key.....	1-10
setup dialog box.....	4-3
setup menu.....	4-1, 4-5
SHIFT key.....	1-10
side grip.....	3-2
snapshot.....	2-11
SNAPSHOT key.....	1-10
soft keyboard.....	4-7, 6-15
soft keys.....	1-9, 4-1
SSD recording.....	2-6, App-7, App-48
standard accessories.....	v
START/STOP key.....	1-9, 4-17
suffix code.....	iv
system configuration.....	1-19
system errors.....	6-12
system information.....	6-17

T **Page**

tap.....	4-4
terminal block.....	5-6
test type.....	6-15
tilted installation.....	3-5
time base.....	2-5
TIME/DIV knob.....	1-7
time reference point.....	1-14, 1-15
time scale.....	2-4, App-2
time setting.....	4-10
top menu.....	1-11, 1-16, 4-5
touch panel.....	4-4
trademarks.....	i
trigger.....	
enhanced trigger.....	2-8
simple trigger.....	2-8
trigger delay.....	2-10
trigger hold-off.....	2-10
trigger hysteresis.....	2-10
trigger level.....	2-10
trigger mode.....	2-5, 2-8
trigger output.....	5-2
trigger position.....	2-10
trigger slope.....	2-10
trigger source.....	2-10

U **Page**

USB keyboard.....	4-8, App-63
USB mouse.....	4-9
UTILITY key.....	1-10
UTILITY Overview menu.....	6-17
UTILITY Self Test menu.....	6-15

V **Page**

vertical installation.....	3-5
vertical position.....	1-6, 2-2
vertical POSITION knob.....	1-6
vertical scale.....	1-6, 2-2
video signal output.....	5-11

W **Page**

waveform acquisition.....	1-7, 2-4, 4-17
waveform display area.....	1-14, 1-18
wave window trigger.....	2-9

X	Page
X-Y waveforms	2-11

Z	Page
zoom method (vertical axis).....	2-3
zoom POSITION knob	1-8
ZOOM (SEARCH) key	1-8
zoom window	1-14, 1-15, 1-18