



## The New Generation in Signal Analysis

**SignalShark**  
seven senses for signals



- ▶ Real-Time Monitoring Receiver
- ▶ RF Direction-Finding and Localization System

## SignalShark – The New Generation in Signal Analysis

**SignalShark – Seven Senses for Signals**

SignalShark – the name says it all. Just like its namesake, the SignalShark is an extremely efficient hunter, perfectly equipped for its task. Its prey: Interference signals. Its success rate: Exceptional. The real time analyzer is a successful hunter, thanks to the interaction of its highly developed sensory functions. Senses that don't miss a thing, and that make it easy for you to identify and track down interferers in real time.

**1 SIGHT**

Thanks to its large dynamic range, the SignalShark can "see" even extremely weak signals even in the presence of very strong signals without problems.

**2 SMELL**

The automatic DF antenna lets the SignalShark "sniff out" the direction of a detected signal in seconds.

**3 HEARING**

Thanks to its high signal sensitivity, the SignalShark can "hear" even very distant signals, and separate and demodulate them.

**4 TOUCH**

The slightest "touch" on the user defined trigger mask causes the SignalShark to record the corresponding signal.

**5 TASTE**

The SignalShark analyzes and evaluates the recorded signal using various classification criteria.

**6 TRACK**

40 MHz real-time measurement enables continuous, reliable detection of even extreme short and infrequent signals.

**7 CAPTURE**

The SignalShark's continuous real time persistence view displays every change in the signal – even in hidden signals.

More and more devices have to share the available frequency spectrum as a result of new technologies such as the Internet of things (IoT), machine to machine (M2M) or car to car (C2C) communications, and the rapidly growing 4G/5G mobile networks. It doesn't matter whether you are making a wideband measurement of entire frequency ranges, or searching for hidden signals, or needing to reliably detect very short impulses, or localizing interference signals – SignalShark gives you all the measurement solutions you need to keep the more and more densely packed radio frequency spectrum free of interference. Its design and excellent performance make the SignalShark ideal for on-site measurements as well as for use as a "left behind" device for monitoring tasks.

- Frequency range: 8 kHz to 8 GHz
- Extremely high sweep rate of up to 50 GHz/s
- 40 MHz real-time instantaneous bandwidth
- High time resolution spectrogram
- Powerful, live persistence spectrum to find hidden signals
- Fully automatic direction finding
- High dynamic range (HDR) receiver

**Tailormade To Your Applications**

SignalShark is ready for the future. That is guaranteed by its open platform design and numerous facilities for expansion. So, it can be adapted optimally to every application.

**SignalShark – The Monitoring Receiver**

The extremely high dynamic range (HDR) of the SignalShark ensures that you can reliably detect even the weakest signals in the presence of very strong signals. This is a basic requirement for most tasks in the field of radio monitoring. The real time spectrum analyzer at the same time also provides audio demodulation, modulation analysis, and level measurement at any frequency and channel bandwidth within the 40 MHz real-time bandwidth. And, if you need even more than the analysis tools of the SignalShark, you can analyze the I/Q data from the receiver internally by installing third party software. You can also stream the data as well as store them internally or externally.

**SignalShark – The Direction-Finding and Localization System**

It is often necessary to locate the position of a signal transmitter once the signals have been detected and analyzed. SignalShark supports the new Automatic Direction-Finding Antennas (ADFA) from Narda, allowing you to localize the source very quickly and reliably. In fact, localization is child's play, thanks to the integrated maps and localization firmware. Conveniently, homing-in using an ADFA mounted on a moving vehicle is also supported. Powerful, state of the art algorithms minimize the effects of false bearings caused by reflections off urban surroundings in real time. Extremely light weight and easy to use manual direction-finding antennas are available for indoor applications.

**SignalShark – The 40 MHz Real-Time Spectrum Analyzer**

Whether in the laboratory or out in the field: With the SignalShark, you have the right analysis tool to hand. It is a winner in both scenarios thanks to its really excellent RF performance and its straightforward application-oriented operating concept. The high real-time bandwidth with very high FFT overlap ensures that you can reliably capture even extremely brief and infrequent signals. The unusually high sampling rate leads to very short measurement times, even if you have to cover a wider frequency band than the real-time bandwidth. Comprehensive evaluation tools ensure that you can perform both current and future measurement and analysis tasks right up to laboratory standards reliably, more simply, and faster than before.



Handheld:  
Weight: Approx. 4.1 kg / 9 lbs  
(with one battery)  
Dimensions: 230 x 335 x 85 mm  
(9.06" x 13.19" x 3.35")

▶ More information  
[www.narda-sts.com/signalshark](http://www.narda-sts.com/signalshark)

▶ **SignalShark – Seven Senses for Signals**



The Handheld Version



- ▶ 2 x smart technology lithium-ion internal and external rechargeable battery packs
- ▶ Hot-swappable for interruption-free long-term measurements

Rugged design for mobile use, even in harsh environments

- ▶ MIL-PRF-28800F class 2

- Baseplate connectors
- ▶ Video display port for external monitor, touchscreen or projector
  - ▶ USB 2.0 for keyboard, mouse, printer, etc.

- 10.4" resistive touch screen
- ▶ Intuitive operation, even when wearing gloves
  - ▶ Selectable day / night view
  - ▶ Customizable GUI with several views for application-oriented, fast, convenient measurement

Microphone to record voice comments



- Top panel connectors
- ▶ Four switchable RF Inputs (1 x N connector, 3 x SMA)
  - ▶ PPS / Trigger Input
  - ▶ 10 MHz reference input
  - ▶ Antenna control connector
  - ▶ Input for additional, external global navigation satellite system antenna
  - ▶ USB 3.0 host for keyboard, mouse, printer, hard disc, WiFi modem, LTE modem, etc.
  - ▶ 1 Gig Ethernet connector for remote control and I / Q streaming
  - ▶ MicroSD card (microSDXC)
  - ▶ 3.5mm headphone jack
  - ▶ DC input / charging connector, plug in / screw on

- ▶ Illuminated keyboard for operation in low ambient light

- ▶ Built-in help function
- ▶ Stealth and keyboard lock

Built-in loudspeaker gives clear, loud sound reproduction, even in noisy environments

Intuitive smartphone style touch operation:

▶ Zoom in – Zoom out



## The Rack Mounted Solution (Built-in Version)



The modular design allows it to be used as a built-in device in a standard 19" rack (single / double) or as a stand-alone solution as a desktop device, for example.

- ▶ Additional analysis software can be run on the internal PC, so communication is only required when an event occurs
- ▶ Analyzer operates autonomously
- ▶ Scalable real-time bandwidth from several analyzers in one rack

STAND-ALONE front



PC is integrated:  
Just connect screen, keyboard,...

- ▶ Power supply 10 to 48 VDC
- ▶ Power consumption < 45 W, typ. 33 W
- ▶ Very compact design 43.5 x 220 x 205 mm

back



4 Inputs: make an external switch redundant

1 Gig Ethernet: for easy high speed integration and streaming into your system

External GPS antenna: for perfect integration into a vehicle

SINGLE 19" rack mounted 1 HU single



DUAL 19" rack mounted 1 HU dual



## The Wall Mounted and Stand-Alone Solution (Outdoor Version)

The smart remote controlled SignalShark Outdoor Unit boasts a robust, weatherproof diecast aluminum casing. The low power consumption and wide temperature tolerance make it ideal for continuous outdoor use. The built-in Windows 10 computer means that much of the preprocessing and analysis can be done by the analyzer itself, which reduces the load on the data connection to the analyzer.

- ▶ Spectrum monitoring
- ▶ Bearing of signals or interference in conjunction with automatic antenna ADFA 1 or 2
- ▶ For angle of arrival (AOA), time difference of arrival (TDOA) and hybrid systems
- ▶ Power supply from power over Ethernet (PoE) or solar panel
- ▶ Communication via Ethernet or modem



Mast mounted Outdoor Unit with solar panel



Wall mounted

Fanless design

Temperature range: -20 °C to +65 °C

IP65 rated

External GNSS antenna and modem, e.g. LTE

Ethernet and/or power supply

Antenna control connector

3 N connector inputs



Power over Ethernet incl. lightning protection

## Localization Made Easy

Once the signals have been detected or analyzed, the location of the transmitting source needs to be found. The SignalShark combined with Narda's new automatic direction-finding antennas (ADFA) and the very powerful map and localization firmware provides reliable bearings in the twinkling of an eye. The bearing results are processed by the SignalShark without needing an external PC. Reliable localization of transmitters has not been possible before with so few hardware components.

### Transmitter Localization

The SignalShark simplifies transmitter localization by autonomously evaluating all the available bearing results and plotting them on a map, using a statistical distribution of bearing lines. The result is a so-called heat map, on which the possible location of the transmitter is plotted and color-coded according to probability.

The SignalShark also draws an ellipse on the map centered on the estimated position of the transmitter that indicates the area where the transmitter has a 95% probability of being located.

The algorithm used by the SignalShark to calculate the position of an emitter is extremely powerful. It can determine the position of the emitter by continuous direction finding even from a moving vehicle in a complex environment such as an inner-city area.

The calculation is continuous in real time, so you can view the changing heat map on the screen of the SignalShark.

### Rapid Automatic Direction Finding

The SignalShark supports the new automatic direction-finding antennas (ADFA) from Narda, which let you take a complete bearing cycle in as little as 1.2 ms. The omnidirectional channel power and the spectrum are also measured during a bearing cycle, so you can monitor changes in the signal level or spectrum concurrently with the bearings.

The ADFA use different antenna arrays, depending on the frequency range. At low frequencies, a pair of crossed coils are used for the Watson-Watt method of direction finding. At medium and high frequencies, a circular array of nine dipoles or monopoles is used for the correlative interferometer direction finding method.

### Interconnected localization

Multiple SignalShark ADFA systems can be linked together in a localization network to provide localization of moving transmitters.



[▶ ADFA Localization](#)



## The Automatic Antennas

Narda offers a large number of automatic and directional antennas for the SignalShark. Their unique characteristics combined with the SignalShark makes them unbeatable.



- High bearing accuracy
- High immunity to reflections
- Rapid direction-finding on signals with a duration of only 2.5 ms corresponding to just two direction-finding cycles
- Built-in omnidirectional reference antenna
- Also takes the elevation bearing. This guarantees that the ADFA DF antennas also deliver stable, precise and reliable data when they get close to the source. You can find more information about the elevation measurement in the Application Note: "Elevation measurement".

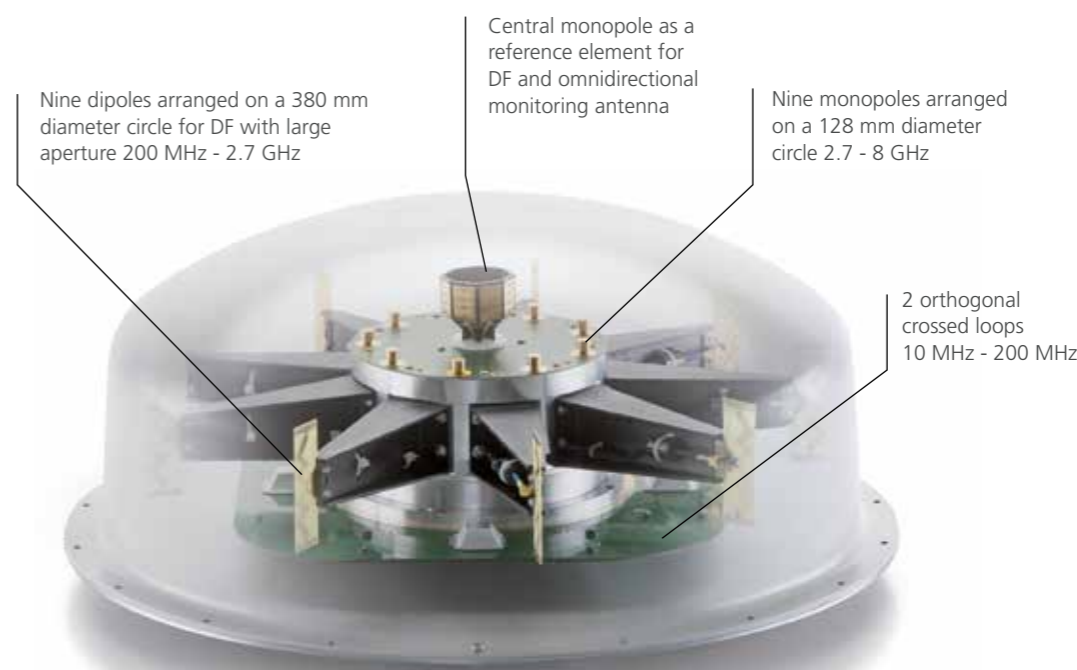

[▶ ADFA antennas](#)



[▶ ADFA mounting instructions](#)



### Automatic DF Antenna ADFA

Direction finding method:

- ▶ 200 MHz - 2.7 / 8 GHz correlative interferometer
- ▶ 10 MHz - 200 MHz Watson-Watt
- ▶ Built-in electronic compass
- ▶ Built-in GNSS receiver with antenna and PPS output
- ▶ Diameter: 480 mm
- ▶ Fixing: Stand, mast, magnetic plate for fitting to any steel vehicle roof

### ADFA 1

Ideal frequency range for interferer localization, e.g. in PMR networks:

- ▶ Frequency range: 200 MHz - 2.7 GHz
- ▶ Bearing uncertainty: 1° RMS (typ.)

### ADFA 2

Broad frequency range for a wide range of localization tasks:

- ▶ Frequency range: 10 MHz - 8 GHz
- ▶ Bearing uncertainty: 10 MHz - 200 MHz 1,5° RMS (typ.) 200 MHz - 8 GHz 1° RMS (typ.)

## The Handheld Antennas

After you have localized the interfering signal using the SignalShark with an ADFA, you will often have to enter a building to find the apartment or office where the source is located. Narda's handy, feather-light directional antennas and active antenna handle are the ideal choice in this situation. The antenna handle does more than just hold the antenna. Among other features, it has a built in operating button that allows you to perform the main steps during manual direction finding, making the combination unbeatable.



- ▶ The handle and the antenna are extremely light, making signal searches less tiring.
- ▶ The convenient plug-in system allows you to change antennas very quickly.
- ▶ The SignalShark recognizes the antenna and applies the appropriate antenna factors for field strength measurements automatically.
- ▶ The SignalShark receives the azimuth, elevation and polarization of the antenna from the 3D electronic compass built into the handle, so manual direction finding could hardly be simpler.
- ▶ The preamplifier built into the handle is activated and deactivated by SignalShark, so you can further reduce SignalShark's low noise figure to detect and take bearings on very weak or distant signals. The preamplifier gain is accounted for automatically when you make field strength or level measurements.
- ▶ The integrated operating button lets you make the main steps in the manual direction-finding process.
- ▶ A plug-in adapter with male N connector allows you to take advantage of the features of the handle even when you are using third-party antennas or external filters.



Active antenna handle with integrated compass and preamplifier  
9 kHz - 8 GHz  
470 g / 1.04 lbs



Feather-light handle and antenna module for fatigue-free interference localization. Display / operation is possible from any smartphone with the help of remote control software.



Adapter, male N connector for OEM antenna



Loop antenna  
9 kHz - 30 MHz  
380 g / 0.84 lbs



Directional antenna 1  
20 MHz - 250 MHz  
400 g / 0.88 lbs



Directional antenna 2  
200 MHz - 500 MHz  
300 g / 0.66 lbs



Directional antenna 3  
400 MHz - 8 GHz  
350 g / 0.77 lbs

## SignalShark – The Ideal Receiver

According to the standards of the International Telecommunication Union (ITU), the SignalShark is very close to being an ideal receiver. This is mainly due to its extremely large dynamic range.



### Extremely High Dynamic Range Brings Clear Advantages

The extremely high dynamic range (HDR) of the SignalShark guarantees that it can reliably measure even the weakest signals in the presence of very strong signals. Along with its excellent mixers and amplifiers, a preselector is also used to achieve this. The excellent dynamic range of the SignalShark is reflected in its intrinsic noise level (DANL) and the so-called large signal immunity parameters, which are the second and third order intermodulation products (IP2 and IP3). It is important that these three parameters are always stated for the same settings of the instrument (e.g. no attenuation, no preamplifier) as they vary considerably according to the settings.

The International Telecommunication Union (ITU) has described what an ideal receiver should in their opinion look like in their Handbook of Spectrum Monitoring: Minimal noise and insensitive to intermodulation. It is defined by three parameters which are measured between 20 MHz and 3 GHz using the same instrument settings:

- DANL = -162 dBm/Hz
- IP2 = +40 dBm
- IP3 = +10 dBm

The SignalShark has the following values at frequencies between 20 MHz and 3 GHz:

- DANL = -159 dBm/Hz
- IP2 = +40 dBm
- IP3 = +14 dBm

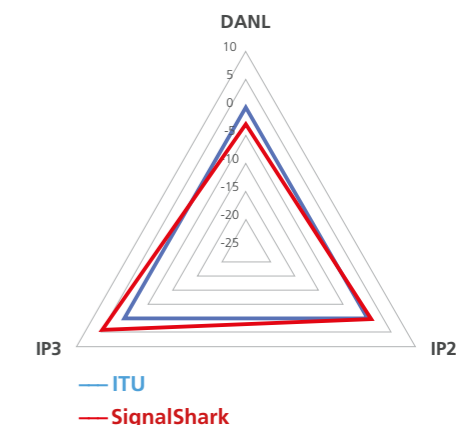

Direct graphic comparison using two superimposed triangles clearly shows that Narda's specifications are almost identical to the theoretical ideal valued determined by the ITU.

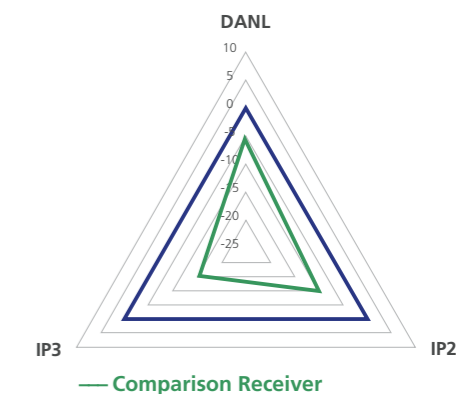

A comparison with a usual standard receiver shows the differences and deviations from the ITU specification. There are clear weaknesses, particularly with the IP3 intermodulation value.

## SignalShark – The Real-Time Monitoring Receiver

### Reliable detection of extremely short and rare events in a 40 MHz real-time bandwidth.

A real-time analyzer calculates the spectrum by applying the FFT on overlapping time segments of the underlying I/Q data within its real-time bandwidth. The real-time bandwidth is only one of the key parameters for a real-time analyzer. The probability of intercept, POI, is easily just as important. This parameter describes the minimum time that the signal must be present for it to be always detected without any reduction in level. This time is affected by the maximum resolution bandwidth RBW and the FFT overlap. The SignalShark is a match for established laboratory analyzers with its minimum duration of 3.125  $\mu$ sec for 100% POI and full amplitude accuracy. The minimum detectable signal duration is < 2 nsec. The SignalShark achieves this by means of high large signal immunity coupled with very low intrinsic noise as well as high FFT overlap and a large resolution bandwidth. SignalShark generally operates with an 87.5% overlap, which is outstanding for a hand-held analyzer.

### Spectrogram Shows More Details Than Ever

With SignalShark, you can use up to three detectors at the same time for the Spectrogram view. This makes it possible for you to easily visualize impulse interference on broadcast signals and get much more information from the spectrogram. The extraordinarily fine time resolution of 31.25  $\mu$ s means that you can completely reveal the time signatures of many signals.

### Persistence View

A color display of the spectrum shows how often the displayed levels have occurred. This enables you to detect signals that would be masked by stronger signals in a normal spectrum view.

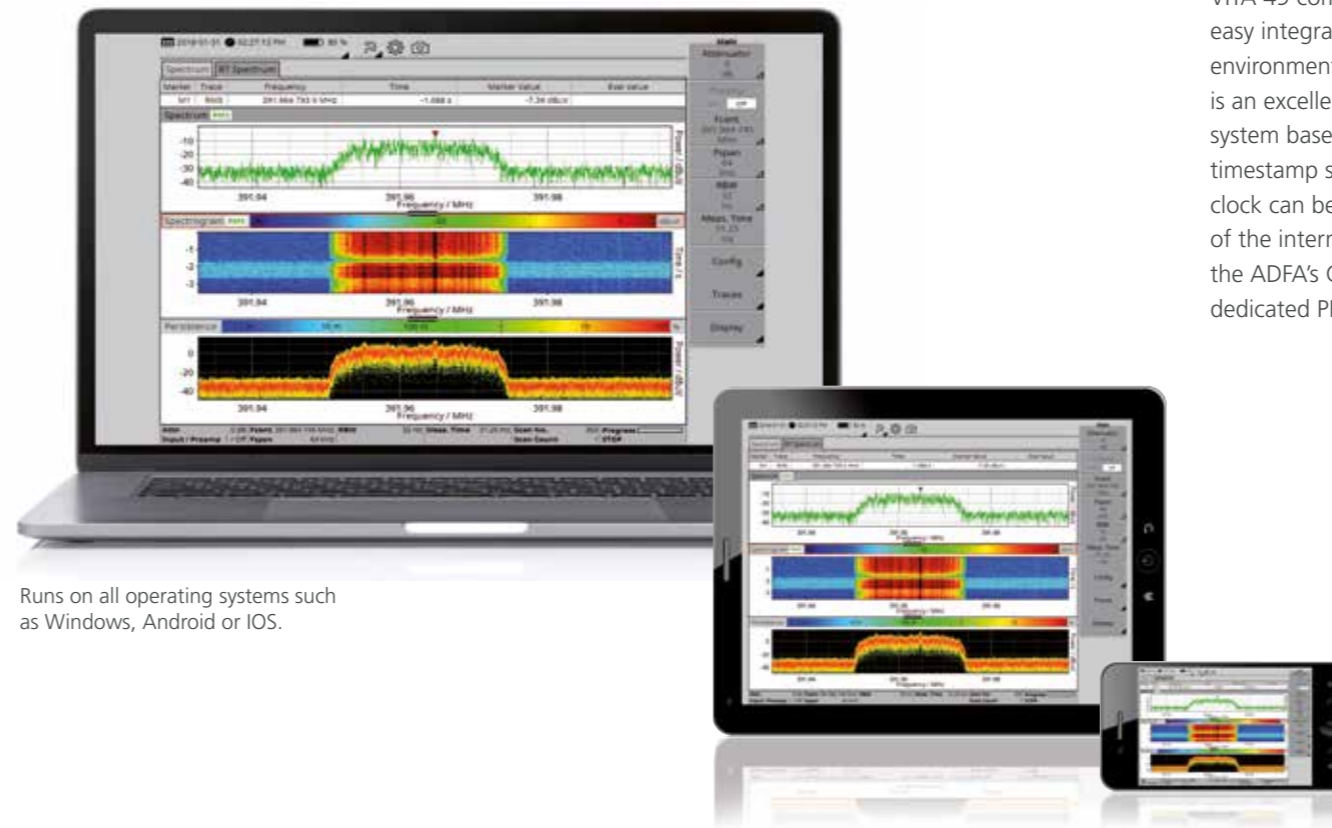

Runs on all operating systems such as Windows, Android or iOS.

### SignalShark – The Real-Time Monitoring Receiver

- HDR: extremely low noise and distortion, simultaneously
- Real-time bandwidth: 40 MHz
  - FFT overlap: 75 % (Fspan > 20 MHz)
  - FFT overlap: 87.5 % (Fspan  $\leq$  20 MHz, RBW  $\leq$  400 kHz)
  - FFT size: up to 16,384
- Minimum signal duration for 100 % POI: 3.125  $\mu$ s at full amplitude accuracy
- Minimum detectable signal duration: < 5 ns
- Persistence: up to 1.6 million spectrums per second
- Spectrogram time resolution: down to 31.25  $\mu$ s
- Spectrogram detectors: up to three at the same time
- RBW: 1 Hz - 800 kHz in real-time spectrum mode, 1 Hz - 6.25 MHz in scan spectrum mode
- Filters conforming to CISPR and MIL for EMC measurements
- Scan speed: Scan rate up to 50 GHz/s
- Detectors: +Pk, RMS, Avg, -Pk, Sample
- Markers: 8, additional noise power density and channel power function
- Peak table: shows up to 50 highest spectral peaks

As well as preparation and presentation, there are many other features for relaying the measurement data:

- Simple screenshot
- Save the measurement data including all frames of a spectrogram for perfect post-processing
- Save the bearings and localizations during interference searches
- Save the raw data (I/Q data)

Available storage media:

- Internal SSD
- One slot for a MicroSD card
- USB 2.0 and 3.0 host connections for connecting to e.g. external data storage media

The Ethernet interface not only allows you to read out the measurement data or share the internal data memory as a network drive, but also enables streaming of the I/Q measurement data with full 16-bit resolution (sample rate up to 25.6 MHz).

VITA 49 compliant I/Q streaming allows easy integration into every software environment. Additionally, the SignalShark is an excellent choice for every localization system based on TDOA, thanks to precise timestamp synchronization. The reference clock can be selected from the PPS signal of the internal GNSS receiver, or that of the ADFA's GNSS receiver, or from a dedicated PPS input.

Remote desktop – Remote control is child's play even over the Internet with Windows 10 onboard applications such as Remote Desktop or popular remote maintenance tools like AnyDesk or TeamViewer. If the SignalShark is connected to the Internet via an LTE modem, for example, specialists can at any time remotely check the device during difficult measurement or direction-finding tasks and even take over set up and operation.

# Open Platform – High-Performance Analyzer Without Limits

The SignalShark Real-Time Spectrum Analyzer is designed as an open platform. It uses the Windows 10 operating system. In contrast to the usual closed systems, this gives test technicians and systems integrators practically unlimited scope thanks to the flexibility of an open platform. Most applications these days run on Windows computers, and so they also will run on the SignalShark. Users can therefore simply install their own software packages on the analyzer for custom measurement tasks. In the same way, any peripheral devices such as printers, displays, or a mouse can also be connected.

### Standard Languages and Formats

The SignalShark family is based on an open platform, so it communicates using standard languages and uses or supports the usual formats that are also in common use in the scientific world. To give some examples:

- ▶ The remote control function makes use of the SCPI command set.
- ▶ Streaming uses the VITA49 I/Q data format.
- ▶ The map materials used during localization can be imported using the well-known Slippy tiles map format.

Python is a further sign of this completely open philosophy. This is a universal and, thanks to its clearly structured syntax, easy to learn programming language. The freely available NardaScriptLauncher installer installs a programming API in addition to Python, which allows all SCPI commands to be addressed via Python functions. With the aid of a standard script editor, it en-

ables simple scripting, that is the creation of smaller programs or scripts. These are ideal for tasks such as autonomous control of the instrument or to perform routine jobs automatically for the test technician. Of all the many possibilities, the example of so-called screen recorder applications particularly well illustrates the advantages of an open platform. These useful features can be installed on the SignalShark as required. In this way it is possible to make a live recording of the measurement process that is actually being performed on the instrument, and even for the test technician to commentate on the proceedings by speaking into an integrated microphone. It is then simple to play back these recordings either directly on the SignalShark itself or to export them as files. The high information content of such recordings means that they have great potential to be used as training videos, for example, even to replace parts of the traditional operating manual.

The open platform with the Windows 10 operating system gives you practically unlimited scope to use other, individual applications.

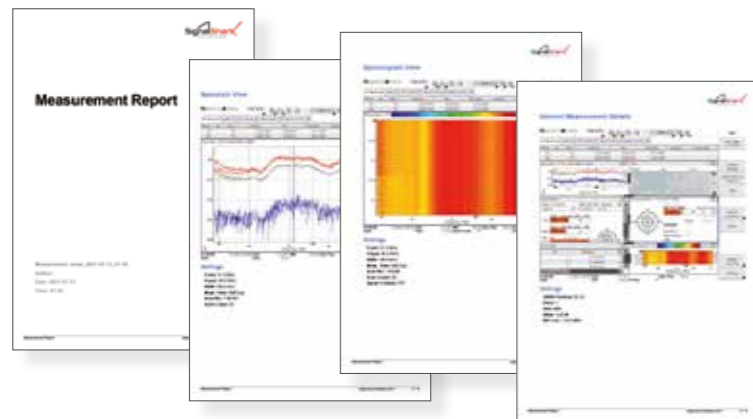

### Script: Report Generator

The Report Generator script maximises and creates a screenshot of each view in sequence and copies it along with the measurement settings into a user definable Word template.

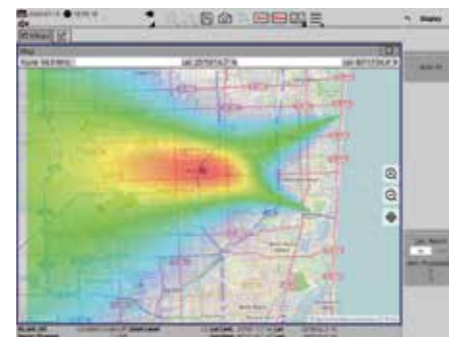

### Script: Cooperative Bearing

Several SignalSharks linked together via the Internet. One SignalShark takes over remote control of the others and receives the bearing results from them, which it combines as triangulations. This enables highly agile localization without the need for a central computer, with minimal outlay.



### Script: Coverage Map

The SignalShark synchronously records the level and position. These can be displayed as a coverage map on the internal map, or imported e.g. into Google Earth by exporting in \*.kml format.



### Third party software and hardware Measuring S parameters

What about a simple test to see if the antenna is working properly? By using the internal Windows 10 computer together with a USB test box for S parameters, generators, etc., the SignalShark can be expanded to perform an almost unlimited range of tasks.

Monitoring, Classification, Demodulation, Decoding, Localization

If the analog demodulators integrated into the SignalShark are not enough, you can add to them without problems using commercially available digital software solutions, such as from Decodio, Procitec or others.

▶ You can find more examples at "Available Driver Software": [www.narda-sts.com/signalshark](http://www.narda-sts.com/signalshark)



Example Decodio spectrum monitoring software

- ▶ Runs directly on SignalShark
- ▶ Includes PMR decoding, e.g. DMR, P25, TETRA, TETRAPOL, dPMR, or NXDN



Example Procitec software

Broadband signal displayed as a waterfall and a FFT spectrum

- ▶ Production of the selected narrow band signal, method detection and decoding mode
- ▶ Classification results: Decoder / Modem
- ▶ Decoding of contents starts after classification

Example Decodio TDOA software solution

- ▶ Example realization of a hybrid AOA/TDOA network
- ▶ Several SignalSharks used as sensors for the network
- ▶ Evaluation and display of the localization results with the aid of Decodio Localizer software on a central PC

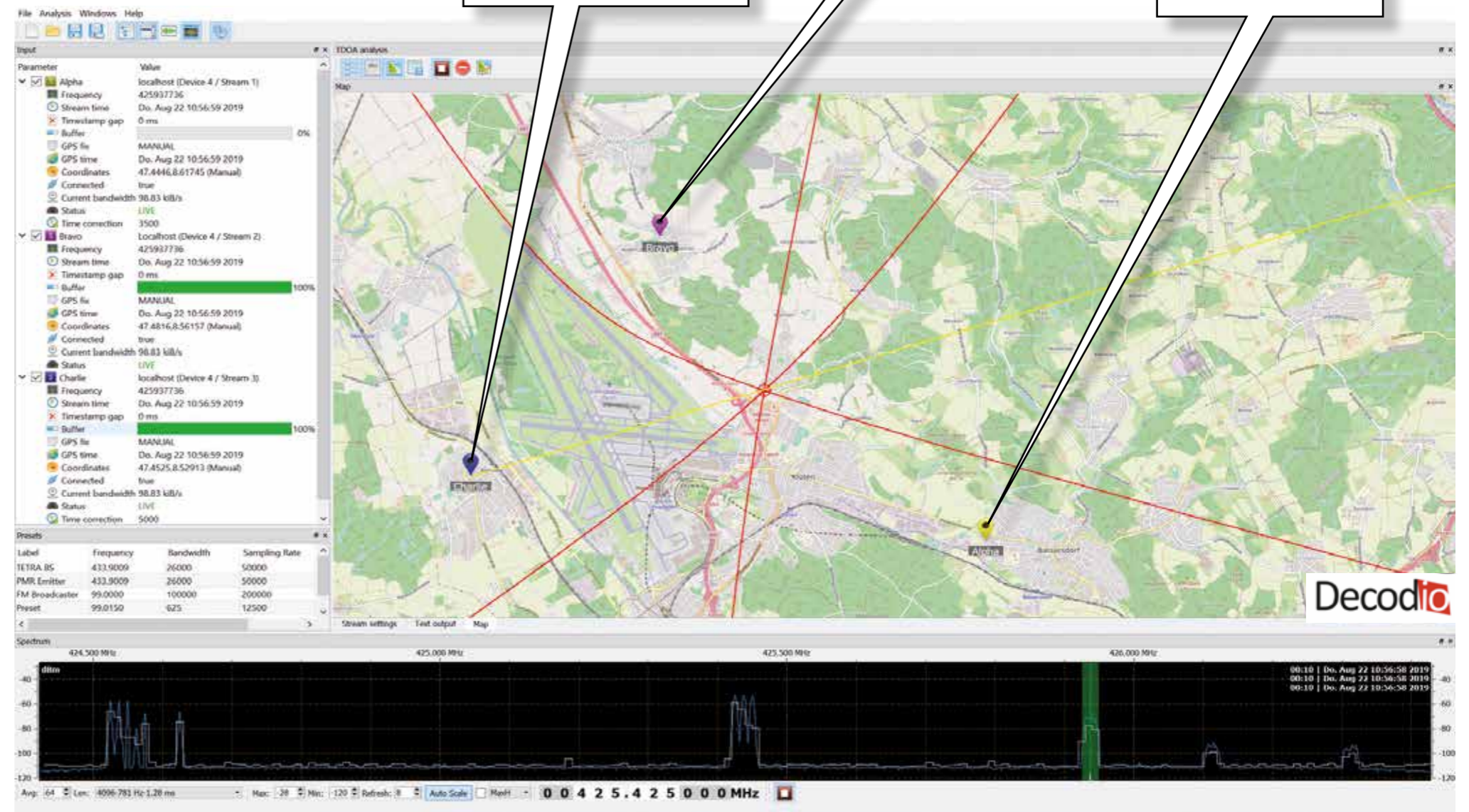

**STATION CHARLIE (fixed installation):**

- ▶ SignalShark Outdoor Unit
- ▶ ADFA
- ▶ LTE modem
- ▶ Software: Decodio ReX



**STATION BRAVO**

- ▶ SignalShark Outdoor Unit
- ▶ Omnidirectional antenna
- ▶ LTE modem
- ▶ Software: Decodio ReX



**STATION ALPHA (mobile):**

- ▶ SignalShark handheld
- ▶ Omnidirectional antenna
- ▶ LTE modem
- ▶ Software: Decodio ReX

## The Perfect Receiver

### SignalShark – the perfect receiver

- CBW: 25 Hz - 40 MHz  
(Parks-McClellan,  $\alpha = 0.16$ )
- Detectors: +Pk, RMS, Avg, -Pk, Sample
- Filters for EMC measurements: CISPR, MIL
- EMC detectors: CISPR-Peak (Quasi-Peak), CISPR-RMS & CISPR-average
- Level units: dBm, dB $\mu$ V, dB( $\mu$ V/m) ...
- Level uncertainty:  $< \pm 2$ dB
- Audio demodulators: CW, AM, Pulse, FM, PM, LSB, USB, ISB, I/Q
- Modulation measurements: AM, FM, PM
- AFC, AGC, Squelch

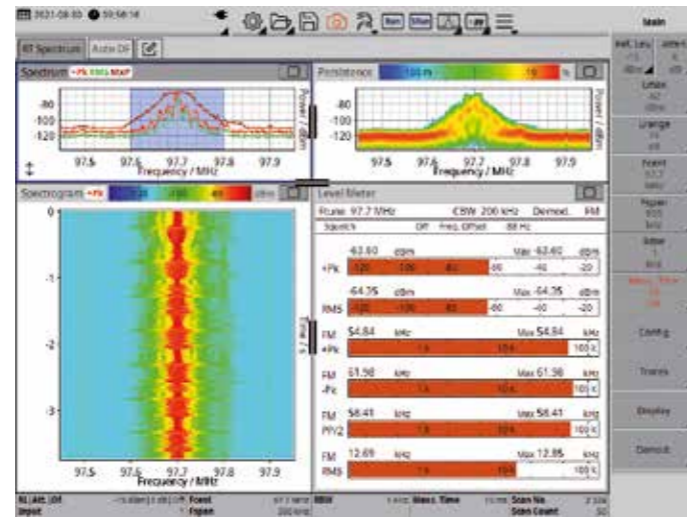

**DDC 2, the Additional Receiver Path**  
The center frequency and channel bandwidth of the additional receiver path DDC 2 can be set within the real-time bandwidth completely independently from the DDC 1 path.  
The I/Q data can be streamed in real time to external devices or they can be processed by the SignalShark itself for level measurements, audio demodulation, and modulation measurements. The very steep cutoff channel filter captures 100 % in the selected channel without any degradation with complete suppression of the adjacent channels.

**CISPR-Compliant EMC Detectors for On-Site Applications**  
All the filters and detectors needed for CISPR or MIL compliant EMC measurements are available for selection for the receiver. If an interferer is detected, you can now decide on the spot whether or not the device needs to be taken out of service because of violating EMC regulations.

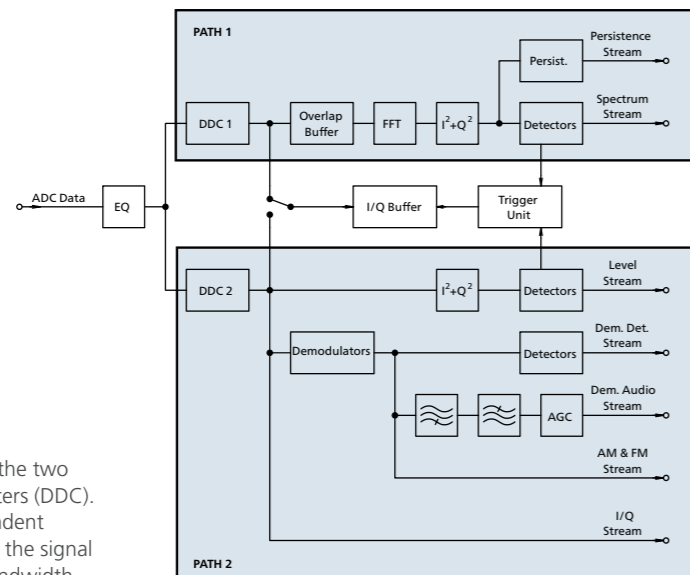

The block circuit diagram shows the two independent digital downconverters (DDC). They allow simultaneous independent monitoring and demodulation of the signal spectrum within the real-time bandwidth.

## SignalShark – The Powerful Solution

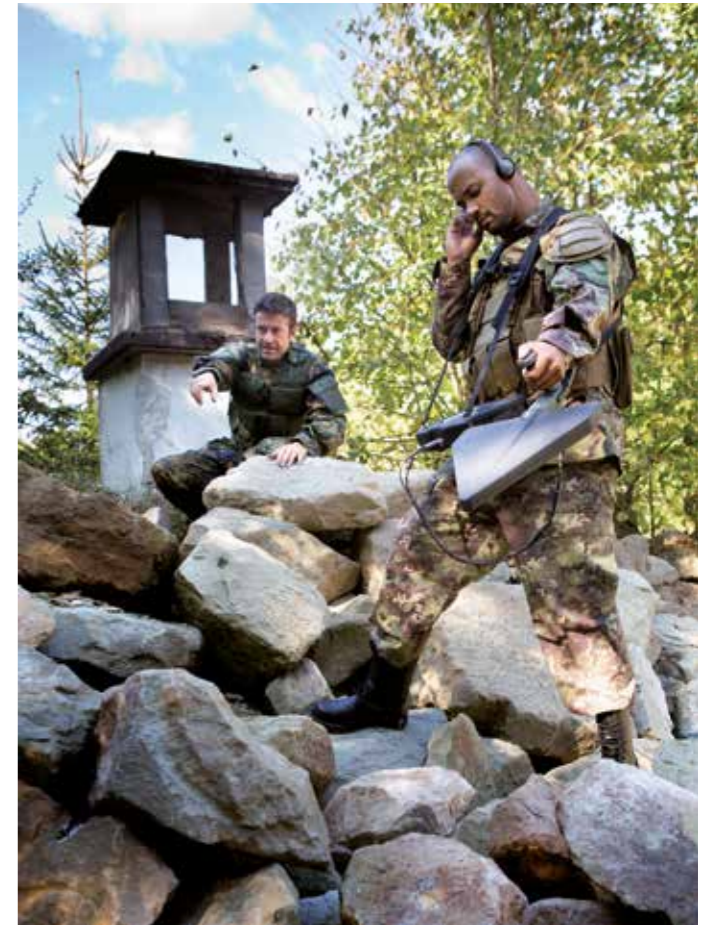



## Narda is a leading supplier ...

... of measuring equipment in the RF test and measurement, EMF safety and EMC sectors.

The RF test and measurement sector covers analyzers and instruments for measuring and identifying radio sources. The EMF safety product spectrum includes wideband and frequency-selective measuring devices, and monitors for wide area coverage or which can be worn on the body for personal safety. The EMC sector offers instruments for determining the electromagnetic compatibility of devices under the PMM brand. The range of services includes servicing, calibration, accredited calibration, and continuous training programs.

**narda**   
Safety Test Solutions

Narda Safety Test Solutions GmbH  
Sandwiesenstraße 7  
72793 Pfullingen, Germany  
Phone +49 7121 97 32 0  
info@narda-sts.com

[www.narda-sts.com](http://www.narda-sts.com)

Narda Safety Test Solutions  
North America Representative Office  
435 Moreland Road  
Hauppauge, NY11788, USA  
Phone +1 631 231 1700  
info@narda-sts.com

